



EnviroMon

User Guide

Contents

1 Introduction	4
1 Safety warning	5
2 The equipment	6
3 The software	7
4 Legal information	8
2 Configuration	9
1 Who will be responsible for the system?	9
2 What do you want to measure?	9
3 Setting alarms	11
4 In the event of power failure	11
5 Data storage and analysis	11
6 Remote data collection	12
7 Equipment placement	13
8 Security	13
9 System testing	13
3 Equipment	14
1 Connections	14
2 Sensors	18
3 Loggers	20
4 Converters	21
5 Alarm Devices	26
6 Package systems	28
4 Getting started	29
1 Installation of a package system	29
2 General installation instructions	29
5 Display options	36
1 Monitor window	36
2 Graph window	37
3 Summary window	39
4 Spreadsheet window	40
5 Events window	41
6 Main settings	43
1 General configuration info panel	43
2 User list dialog box	49
3 Logger dialog box	51
4 Sensor list dialog box	59

7 Miscellaneous settings	63
1 Preferences	63
2 Monitor	65
3 View	66
8 How to...	69
1 Configure a system	69
2 Use multiple loggers	70
3 Use a dial-up modem	70
4 Measure parameters other than temperature	71
5 Supply a user-defined scaling file	71
6 Transfer data to other applications	73
7 Display data on a web site	73
8 Safe method	74
9 Interactive method	75
10 Command line data export	75
9 Drivers	78
1 Windows drivers	78
2 API	78
3 C	79
4 C++	80
5 Delphi	80
6 LabVIEW	80
10 Troubleshooting and maintenance	81
1 Troubleshooting	81
2 Maintenance	82
3 Calibration	82
11 File formats and other useful information	85
1 Program files	85
2 Envimon.ini	85
3 .RDG files	90
4 EMWEVENT.LOG	91
5 DDE	91
12 Communications protocols	92
1 EnviroMon logger protocol	92
13 Messages	95
1 Computer messages	95
2 Converter light	95

Index	96
--------------	-------	-----------

1 Introduction

The EnviroMon system is designed for long-term recording of data from a number of locations. It offers the following features:

- Permanent retention of recorded data on PC
- Wide range of data display and analysis options
- Easy-to-use software
- Telephone style connections for easy installation
- Modular system for easy upgrades
- A wide range of options to report alarm conditions
- Support for remote data download (modem, GSM etc)

1.1 Safety warning

We strongly recommend that you read the general safety information below before using your product for the first time. If the equipment is not used in the manner specified, then the protection provided may be impaired. This could result in damage to your computer and/or injury to yourself or others.

Maximum input range

The EnviroMon system is designed for use with many different converters, sensors and signals.

Converter	Designed input range	Max input voltage
EL001	Cannot measure voltages	N/A
EL026	Cannot measure voltages	N/A
EL016	V to +2.5 V	±30 V
EL037	V to +10 V	±30 V
EL040	V RMS AC	±30 V
EL041	±60 mV	±10 V

Any voltages in excess of the maximum input voltage specified in the above table may cause permanent damage to the unit.

Mains voltages

Pico products are not designed for use with mains voltages.

Safety grounding

The ground of every product is connected directly to the ground of your computer via the provided interconnecting cable. This is done in order to minimise interference. Always use the provided cable to attach the product to your computer.

As with most oscilloscopes and data loggers, you should take care to avoid connecting the ground input of the products to anything which may be at some voltage other than ground. If in doubt, use a meter to check that there is no significant AC or DC voltage between the ground input and the point to which you intend to connect it. Failure to check may cause damage to the products and/or computer and could cause injury to yourself or others.

Take great care when measuring near mains equipment. If a sensor is accidentally connected to mains voltages, you risk damage to the converters or your computer and your computer chassis may become live.

You should assume that the products do not have a protective safety earth. Misconfiguration and/or use on voltages outside the maximum input range can be hazardous.

Repairs

The units contains no user serviceable parts: repair or calibration of the units requires specialised test equipment and must be performed by Pico Technology Limited or their authorised distributors.

1.2 The equipment

An EnviroMon system consists of the following items:

- Computer
- Logger
- Multiple converters
- Alarm options

The following diagram shows how a typical system might be set up.

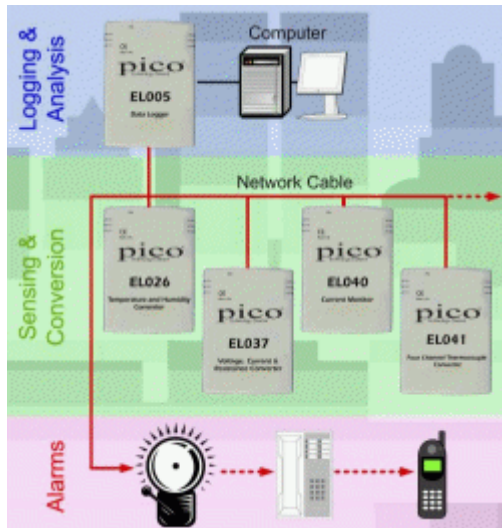

The EnviroMon PC application performs the following tasks:

- System configuration
- Long-term data storage
- Display, analysis and printing of recorded data

The computer can communicate with loggers using each of the following communication methods:

- Direct connection to a local logger
- Telephone modem to a logger on a remote site
- Radio link, for short-range connection to sites not serviced by telephone
- GSM telephone, for remote or mobile applications

The logger stores data continuously, even when the computer is turned off or disconnected, or the mains fails.

The logger connects to a number of converters that take measurements. The converters can be up to 400 metres away from the logger, and are connected using a single, low-cost, telephone cable that forms a 'network' between the logger and the converters.

1.3 The software

EnviroMon is used both to configure an EnviroMon system, and to extract and analyse data from the system. To run EnviroMon under Windows 95, 98, ME, NT, 2000 or XP:

1. Click the **Start** button
2. Select **Programs**
3. Select **Pico Technology**
4. Select **EnviroMon**

When you first start up the EnviroMon software, the system is not yet configured, so the computer displays the configuration panel.

The top button on the Configuration control panel selects a guided tour: this will take you, step by step, through the process of setting up a simple system.

The final stage of configuring a system is to click the **Program** button: this writes a configuration to the logger.

When you start up the EnviroMon software after the system has been configured, the software transfers the readings stored in the logger to a data file on your computer, then displays the Monitor window, which shows the current value of each measured parameter.

1.4 Legal information

The material contained in this release is licensed, not sold. Pico Technology Limited grants a license to the person who installs this software, subject to the conditions listed below.

Access

The licensee agrees to allow access to this software only to persons who have been informed of these conditions and agree to abide by them.

Usage

The software in this release is for use only with Pico products or with data collected using Pico products.

Copyright

Pico Technology Limited claims the copyright of, and retains the rights to, all material (software, documents etc) contained in this release. You may copy and distribute the entire release in its original state, but must not copy individual items within the release other than for backup purposes.

Liability

Pico Technology and its agents shall not be liable for any loss, damage or injury, howsoever caused, related to the use of Pico Technology equipment or software, unless excluded by statute.

Fitness for purpose

No two applications are the same: Pico Technology cannot guarantee that its equipment or software is suitable for a given application. It is your responsibility, therefore, to ensure that the product is suitable for your application.

Mission-critical applications

This software is intended for use on a computer that may be running other software products. For this reason, one of the conditions of the license is that it excludes usage in mission-critical applications, for example life-support systems.

Viruses

This software was continuously monitored for viruses during production, however you are responsible for virus-checking the software once it is installed.

Support

If you are unsatisfied with the performance of this software, please contact our technical support staff, who will try to fix the problem within a reasonable time scale. If you are still unsatisfied, please return the product and software to your supplier within 28 days of purchase for a full refund.

Upgrades

We provide upgrades, free of charge, from our web site at www.picotech.com. We reserve the right to charge for updates or replacements sent out on physical media.

Trademarks

Windows is a registered trademark of Microsoft Corporation. Pico Technology Limited and EnviroMon are internationally registered trade marks.

2 Configuration

EnviroMon is a very flexible system. It is made up of a number of separate modules: you simply choose the modules that you need to do the job. In addition, there are several software options that can be configured so that the logger will do exactly what you want.

This section describes the points that you should consider when setting up an EnviroMon system.

2.1 Who will be responsible for the system?

For a small configuration, one person can easily install the system and operate it daily.

Larger systems are often installed by external contractors, but it is essential to have someone within the company who will be responsible for maintaining the system once it is installed. This person should be involved at the earliest stages in the planning of the system, so that they understand how it works and can easily make small changes to the system as requirements change.

2.2 What do you want to measure?

EnviroMon takes readings from a number of sensors distributed around a site. These sensors are connected to converters that transform the analogue signals from the sensor into digital signals: these digital signals can then be transmitted reliably and accurately to the logger. The type of sensor and converter you require depends on what you wish to measure.

2.2.1 Temperature

EnviroMon provides full support for two different temperature measuring techniques: it can also work with other techniques if required.

- Precision thermistors are relatively low cost and they are highly accurate (0.1°C), but only over a relatively limited temperature range, for example -40°C to 30°C or 0°C to 70°C.
- Thermocouples work over a wide range; they are available in a wide variety of probes from a large number of suppliers. Connectors are standardised, so thermocouples from different suppliers are interchangeable.

Thermistors

The standard EL015 temperature sensor is a precision thermistor sealed in a stainless steel cylinder. The sensor is fitted with a 5-metre cable and a connector which plugs straight into an EL001 temperature converter. Each EL001 can accept three sensor inputs. The sensor cable can be extended to a maximum of about 100 metres: this will introduce an error of less than 0.1°C in the temperature measurement.

At temperatures below 0°C, the cable may become brittle, and must not be flexed. At temperatures over 70°C, the cable may become soft and easily damaged.

The EL015 temperature sensor has an accuracy of 0.1°C over 0°C to 30°C, and 0.2°C over -20°C to 50°C. Outside this range, we recommend the use of Type K sensors.

Thermocouples

The 4 channel EL041 thermocouple converter is designed to be used with any type of thermocouple with a miniature-thermocouple connector across a wide range of temperatures (range depends on the thermocouple used). The EL041 can also be used to measure ± 60 mV signals.

When extending thermocouple cables, it is essential to use thermocouple extension cable and connectors of the same type.

2.2.2 Humidity

EnviroMon can measure humidity using the EL030 temperature and humidity sensor and EL026 converter. The converter contains calibration information for the sensor, so the units are supplied as a pair. The EL030 contains both a temperature sensor and a humidity sensor. The humidity sensor has a calibrated accuracy of 2.5%.

2.2.3 Electric current

EnviroMon can measure current with the three channel EL040 current monitor converter. Which has a 1 volt AC RMS input range, making it suitable for use with a wide range of current transformers.

Measuring mains current

The TA011 current clamp is ideal for measuring mains current for industrial or home applications. These clamps can be purchased separately or as a current monitoring kit designed for monitoring 3 phase supplies. This kit includes the logger, current monitor converter and 3 current clamps.

2.2.4 Other parameters

The following two general-purpose converters are suitable for use with the EnviroMon system:

- EL016 8-channel voltage converter
- EL037 3-channel voltage / 4-20 mA converter (4 channels with EL005)

The EL016 has eight inputs that can measure signals between 0 and 2.5 volts. EnviroMon can be programmed to convert the voltages into some other units (for example, pressure) and display them in those units.

The EL037 has three inputs (four when used with the EL005) that can be configured to measure 2.5 volts, 10 volts and 4-20 mA. EnviroMon can be programmed to convert the measurements into some other units (for example, pressure) and display them in those units.

Bear in mind when selecting sensors that EnviroMon is a low-power system, so that it can carry on running when mains fails. Where possible, select low-power sensors. If it is essential to use a sensor that requires a lot of power (for example gas sensors), you should consider providing a local power supply.

2.3 Setting alarms

EnviroMon can be configured to sound an alarm if a measurement (such as temperature) goes out of range (high or low) or if a sensor fails. For many applications, it is not necessary to have alarms for all sensors, so the alarm function for any sensor can be disabled. It is also possible to enable the alarm only during certain time ranges, for example during working hours (eg 9 to 5, Monday to Friday).

It may be desirable to have an alarm on sensor failure, but not on temperature out of range. This can be done by leaving the alarm enabled and setting a wide temperature range. If the temperature normally goes out of range for short periods, it is possible to hold off (delay) alarms for a specified period. For example, if a freezer periodically goes through a defrost cycle lasting 15 minutes, an alarm holdoff of 20 minutes would prevent the defrost cycle from causing alarms.

The high and low threshold, disable and holdoff can be set individually for each sensor. It may be necessary to use a remote audible alarm, either in the workarea or in a security control room. This can be linked to the logger using the network cable. If it is necessary to respond to alarms when the site is unmanned, the alarm dialler module can make telephone calls to several numbers and deliver a voice message.

2.4 In the event of power failure

In the event of a power failure, the EL005 logger will continue operating from its internal battery backup. This internal battery recharges automatically when mains power is restored.

For some applications, it is not necessary to collect or store data if mains power fails.

2.5 Data storage and analysis

Data storage and analysis requirements vary enormously, depending on the application. There are three main options:

- Monitor temperatures - use the logger only for immediate temperature monitoring and alarms
- Print out reports at regular intervals, directly from the logger
- Store the data on computer

The logger can print the current temperatures, and a periodic summary showing the minimum, maximum and average readings, together with the number of alarms and the total alarm duration. This approach is useful if there is not space for a computer, or if staff are not familiar with computers. These reports can be printed out either at regular intervals, or on request.

If a computer is used, data is transferred to the computer automatically each time the user runs the EnviroMon program on the computer. Storing data on the computer has a number of advantages:

- Data can easily be backed up for added security
- If the computer already has access to a printer, it is not necessary to buy a separate printer for the logger
- The computer software offers a wider range of report formats
- It is possible to transfer data to other applications for further analysis
- The computer need not be on the same site as the logger (see remote data access)

Once data is stored on the computer, it can be processed via a number of outputs:

- A spreadsheet-style display, which can be transferred to a spreadsheet for further analysis
- A graph of readings against time, over periods from hours to years
- A period summary which shows the minimum, maximum and average reading for each sensor during the period, together with the number of alarm events and the total alarm duration
- A list of alarm events: it is possible to add notes about action taken on alarm

It is possible to specify a backup path for files: this can either be a diskette or a network drive. If you specify a diskette, the backup should be done manually, using the backup option on the file menu. If you specify a network drive, you can also request an automatic backup each time you exit from the program.

It is also possible to specify that old files should be deleted after a period of time: the options are:

- Never
- Delete after a month
- Delete after a quarter
- Delete after a year

If you are collecting data every minute from a single source, this will require about 1.6 MB per year. Most computers have at least 1000 MB of disk space, so it is not usually necessary to delete old data.

2.6 Remote data collection

It is possible to access logger data remotely using either a radio modem or a telephone modem.

Radio modem

One computer can maintain radio modem links to several remote loggers. Because EnviroMon requires very little power, the remote loggers can easily operate using a battery that is kept charged using a solar panel. The logger has built-in power saving features to turn off the radio modem when it is not required.

Warning: In order to comply with current legislation, use only radio modems which comply with the RTTE directive.

Telephone modem

The EnviroMon software running on a PC can use a modem to make a telephone call to a remote logger, then extract data from the logger and terminate the connection.

The logger can be configured to permit the modem to answer telephone calls only during a narrow time range. This means, for example, that the logger data can be downloaded at night using a telephone line that is allocated for other uses during the day.

2.7 Equipment placement

Each EnviroMon converter turns sensor inputs into digital signals, which can be transmitted quite long distances through the network cable. Converters should be no more than 400 metres from the logger. The logger can therefore be placed wherever information is required, for example in an office area, and the converters can be placed near where parameters are to be measured.

Thermistor sensors are supplied with a 5-metre cable that can be extended up to 100 metres. Alarm relay and dialler modules are best placed close to the logger, to minimise the risk that a break in the network could prevent the logger from operating the relay or dialler.

2.8 Security

The EnviroMon software normally allows full access to both the data display and configuration functions. If, however, you enter details of users, you can specify which users are allowed to access the configuration menu.

2.9 System testing

It will be necessary to check that all parts of the system work - this is essential once the system is installed, and should be repeated at least yearly thereafter. We recommend that you create a checklist of features to test, while you are deciding what the configuration will be, then you can use this checklist once the system is installed. If possible, you should operate the system for a period of time to ensure that it is working correctly, before you start to rely on the results.

When deciding on tests, the test should be as lifelike and as complete as possible. For example, if you are using a dialler, you should simulate a fault, then verify that the logger activates that dialler, the dialler calls the correct telephone numbers, and the persons called understand how to acknowledge the call.

3 Equipment

The network is a four-wire cable which carries power and data between the logger, converters and optional equipment such as remote alarms. The logger can be attached anywhere along the network cable. The network will operate correctly with about 400 metres of standard network cable between the logger and the furthest converter: this distance can be increased to a km or more using thicker cable.

The network can be built in each of the following four ways:

- Connect each converter to the next using EL003 network cables. Each cable is 5 metres long, so the units must be within five metres of each other
- Make up longer versions of the network cable, then connect each converter to the next using these cables (you will need a crimp tool, available from Pico to attach the plugs to the cables)
- Install a fixed cable around the site with an EL009 telephone wall-socket at each point where a converter or logger is to be installed, then connect the logger and converters to the wall-sockets using 5-metre EL003 network cables
- Install a fixed cable directly between converters. This is necessary when devices are fitted with screw terminal blocks ie. alarm relay, dialler, and network junction box

3.1 Connections

3.1.1 Types of network

Small network

For small networks - where all converters are within a 5 metres of each other - it is possible to put together a network using only standard network cables.

The logger and converters each have two network sockets. By connecting a network cable from one unit to the next you can build up a complete network.

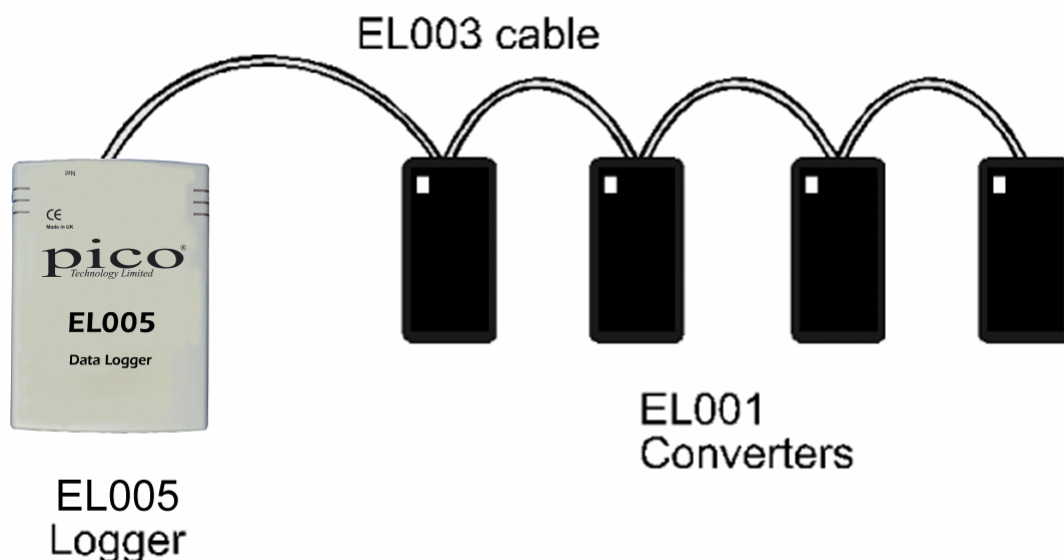

Larger network

For larger networks, the same approach may be used. The network cables must be made up on site to the length required, using cable WI001 and connecting the CO018 connectors to the cable using a crimp tool.

In some circumstances it might be more convenient to use a spur cable to link some of the connectors.

Fixed network

For the largest networks, ie a large number of converters or converters which are widely spaced, the most satisfactory installation is a fixed network. Place an EL009 wall-socket at each location where a converter or logger is required and use a standard 5-metre cable to connect the socket to the logger or converter.

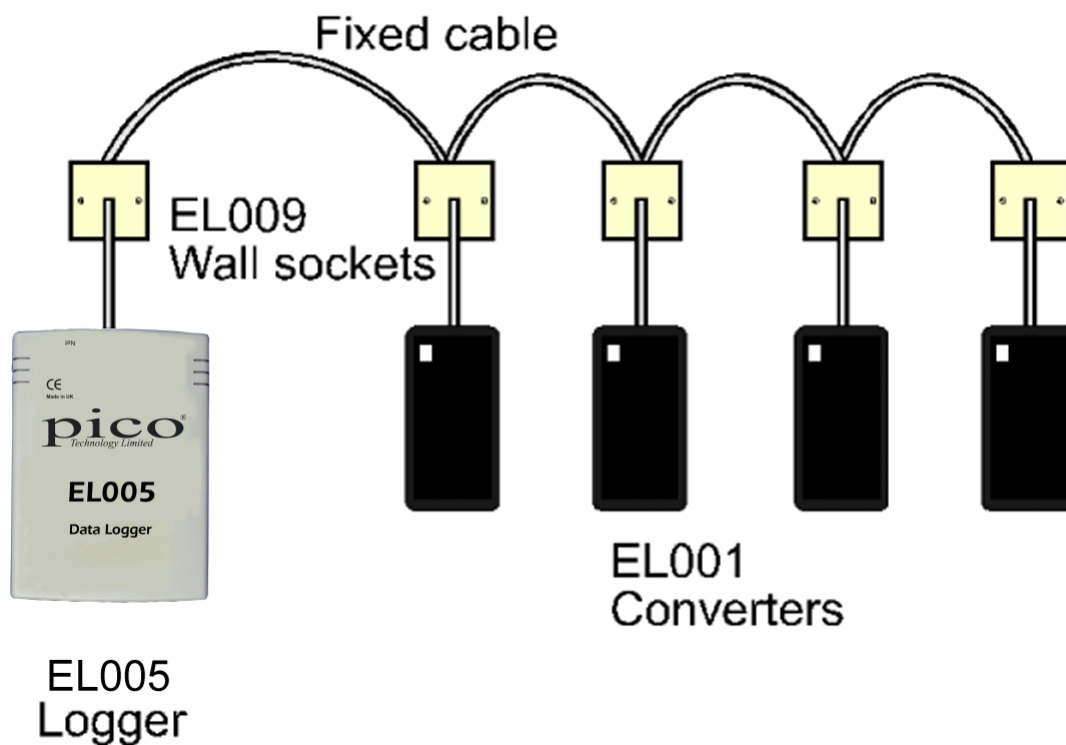

3.1.2 Connectors

It is very easy to set up a small system, all of the parts connect together using the telephone-style FCC68 connectors. To prevent incorrect assembly, the following two different types of connector are used:

- CO018 - network cables use a wide connector that has six slots and four pins - the outer two slots are unused
- CO017 - sensor cables use a narrow connector that has four pins in four slots

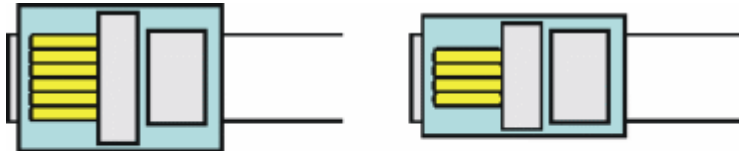

CO018 Network

CO017 Sensor

3.1.3 Screw terminal connections

The following two EnviroMon devices are fitted with screw terminal blocks:

- EL018 dialler/battery backup unit
- EL021 network junction box

The screw terminal block connects the device to the network instead of using the telephone sockets. The following diagram shows the connections linking the device to an EL009 wall socket:

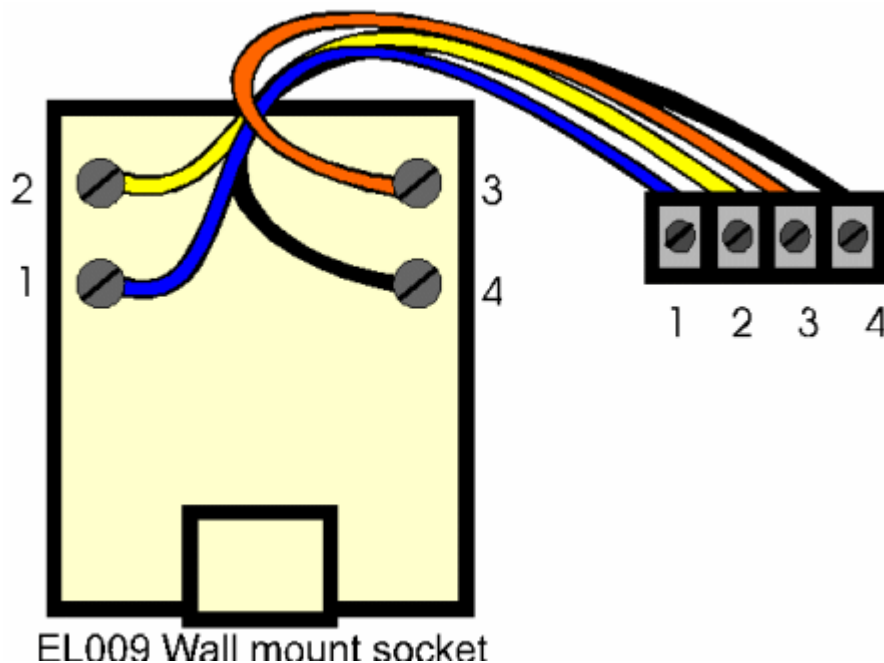

Connect adjacent units using four core cable, eg WI003. Connect terminal 1 to terminal 1, terminal 2 to terminal 2, and so on. The following table shows the signals associated with each connection:

Connection	Signal
1	Data A
2	Data B
3	Power (12-18V)
4	Ground

3.1.4 Sensor connections

If you need to connect flexible cable sensors to standard converters, proceed as follows:

1. Attach a sensor connector to a length of 4 core flat cable
2. Connect the two wires from the sensor to the left-hand two wires on the length of 4 core cable

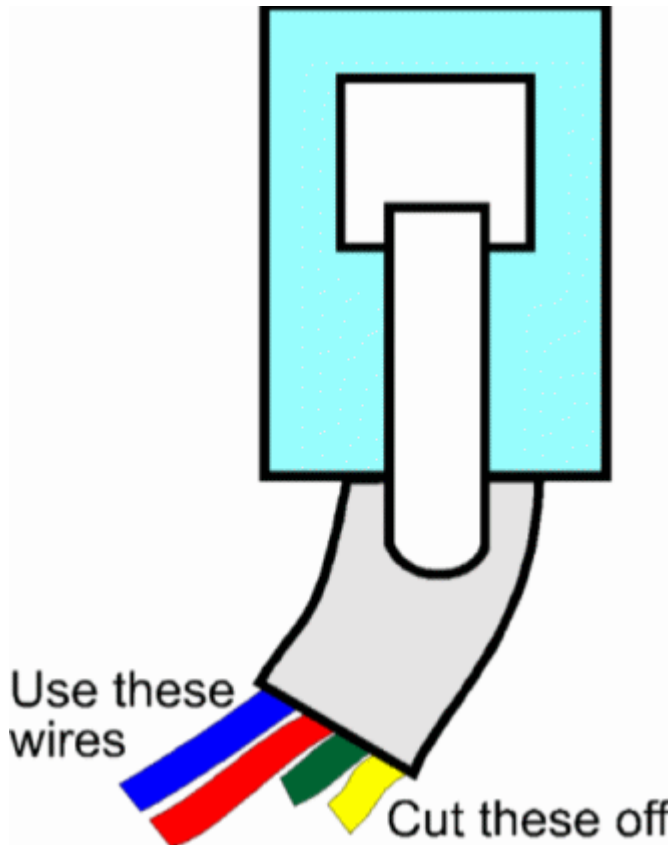

3.1.5 EL020 sensor adaptor

The EL020 sensor adaptor has two sensor sockets, back to back. If it is necessary to extend a sensor cable, it is easy to do this by making up a cable of the required length with plugs at each end, then using the EL020 to attach one end of this cable to the sensor cable.

C0017/WI001 Extension
(up to 100 metres)

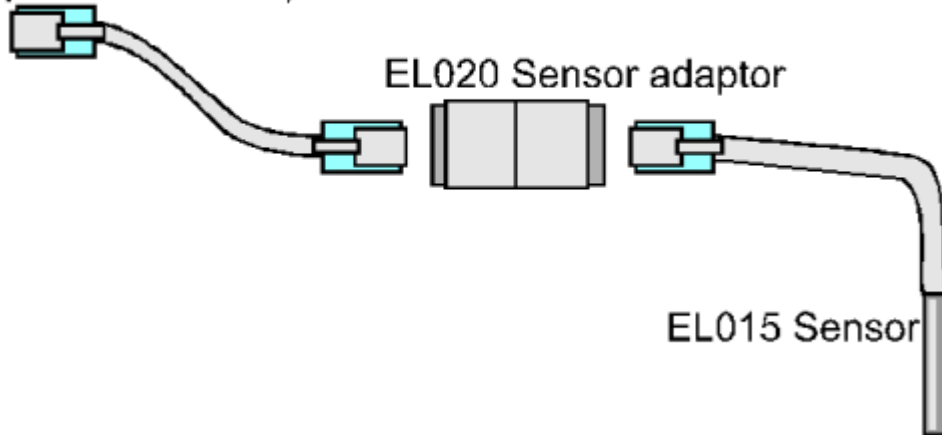

3.2 Sensors

3.2.1 EL015 temperature sensor

A sensor is required at each location where you wish to measure temperatures.

The EL015 temperature sensor is a steel tube about 5 cm long. It has a 5 m cable and there is a sensor connector at the other end of the cable. The sensor should be located where you wish to measure the temperature, eg in a refrigerator, tank or room. The connector fits into one of the three sensor sockets on a converter.

The sensor can be attached either directly to the converter, or using an extension cable up to 100 metres long. The EL020 sensor adaptor provides an easy way of extending sensor cables. The standard sensor extension cable, the EL032, is 5 m long.

Standard sensor cables are not flexible at low temperatures: if it is necessary to move the cables, they should be warmed up before flexing.

3.2.2 EL030 temperature and humidity sensor

The EL030 temperature and humidity sensor is designed for use with the EL026 temperature and humidity converter. The sensor has a label on the base which shows the serial number of the sensor and also two numbers indicating the calibration information of the humidity sensor. For best results, calibrate the EL026 for a specific sensor using the calibration procedure supplied.

3.2.3 TA011 current clamp

The TA011 current clamp requires no power and is capable of measuring up to 300 A in the frequency range 50 to 60 Hz making it an ideal sensor for monitoring mains current. The TA011 generates 1 mV for each ampere flowing through a cable.

Specifications

Sensor type	Transformer
Current input range	0.1A to 300A AC RMS
Accuracy	<50A \pm 3.0% >50A \pm 2.0%
Frequency response	50 to 60 Hz
Output voltage	1mV AC per 1A AC
Operating temperature	0 ^o C to 50 ^o C
Maximum conductor size	29mm

Safety note

The current clamp is designed to be used on insulated wires. Using the clamp on uninsulated wires may damage the equipment and/or cause injury to yourself or others.

3.2.4 SE0xx thermocouples

Thermocouples for use with the EL041 thermocouple converter are as follows:

SE000 Exposed Wire PTFE Thermocouple

- Chemically inert sheath
- Exposed wire junction
- Fast response time

SE001 Exposed Wire Fibreglass Thermocouple

- Tough fibreglass sheath
- Exposed wire junction
- Fast response time

Note: All of the above thermocouples are Type K.

3.3 Loggers

3.3.1 EL005 logger

The EL005 logger has no display or buttons, so it can only be used with a computer. Neither does it have an internal alarm: if you need an audible alarm, connect an EL006 audible alarm unit to the network.

Specifications

Sampling rate	1 to 240 minutes per sample
Max. readings	250,000
Max. no of converters	10
Max. no of sensors	40
PC connection	Serial port
Power supply	12 V DC unregulated ...or 14-18 V DC regulated
Battery backup	Internal rechargeable cells

Connections

The logger has four sockets on one end:

- A round DC power socket: the cable from the mains adapter supplied with the logger plugs in here.
- Two square network sockets
- A D-shaped serial port socket which connects either to a computer serial port or to a printer using the serial port adapter supplied.

The logger also has a red light (LED) next to the serial port.

Batteries

The EL005 logger has internal re-chargeable batteries. These batteries are kept topped up whilst mains power is available, and will keep the system running for up to 72 hours during a mains power failure. The EL018 dialler adapter/battery backup can provide power to the system for much longer periods in the event of mains failure.

The unit switches to battery power as soon as the mains power is disconnected, so it will take some time for the batteries to recharge after a long period without mains power.

LED

When the unit is first powered on, the red light comes on continuously while it carries out a self test. If the unit is not configured, the light flashes at a uniform rate, once per second. If the unit is configured, the light shows traffic on the EnviroMon network: this normally shows as a sequence of very short pulses every three to five seconds.

3.3.2 Logger internal parameters

The logger can record a number of internal parameters. These are as follows:

- Mains voltage
- Network current
- Date
- Time

The mains voltage is an approximate measure - within about 20% - but readings for a particular logger and power supply will be consistent. There are two parameter options - one for 110 V operation and one for 240 V operation.

The network current gives an indication of the current supplied to all of the converters on the network. It should not exceed 100 mA.

The EnviroMon software assumes that the date and time of the computer are correct: data is stored using this information. Unfortunately, some computer clocks are not always reliable. The date and time parameters can be used when it is necessary to be certain that a given data item was recorded at the date and time specified. The date and/or time are stored by the logger as parameters, at the time the reading is recorded.

3.4 Converters

3.4.1 Introduction

A converter samples the output of sensors connected to it and gives these samples numerical values. The numbers then go to the logger that is connected to the converter.

Each converter has an address, which identifies it to the logger. Most converters are supplied with the address set to 1. The **Change converter address** program can be used to change the address.

You can have up to 10 converters for each system using a mix of standard, humidity or voltage converters.

3.4.2 EL001 temperature converter

The standard converter is a small black box. There are three narrow sockets at one end: these are for sensors. At the other end, there are two wide sockets for the network, and a red LED.



The LED flashes continuously immediately after the system is turned on. Once the system is running normally, the light goes out and, thereafter, flashes briefly each time the converter takes a reading.

Each converter has an 'address' - a number between 1 and 15 - written on the top right hand corner. Each converter on the network must have a different address which relates to its position on the network. The converter will already be programmed with an address but you can change this through the installation software. The three sockets are marked with channel numbers.

When you install the system, the logging software will ask you for the address number and where each of the three sensors are which relate to that converter address. For large networks, it is best to make a plan of the layout before starting installation.

3.4.3 EL016 voltage converter

The EL016 voltage converter accepts eight voltage inputs. Each input can accept a voltage in the range 0 to 2.5 volts.

The voltage inputs connect to the EL016 via a D9 female connector. The following table shows the pin connections and channel numbers for an EL016 with address set to 1; 'A' will be address 1; 'B' will be address 2 and 'C' will be address 3.

Address	Channel	Pin
A	1	5
A	2	9
A	3	4
B	1	8
B	2	3
B	3	7
C	1	2
C	2	6
Ground		1

It is possible to display the voltages as other parameters - see the PSC file section of the signal conditioner help file for more information.

3.4.4 EL026 temperature and humidity converter

The EL026 needs to be calibrated for a specific EL030.

Specifications

Humidity	Range	0 to 95% non-condensing*
	Accuracy	±2.5% (0 to 90%)
	Response time	
	Vigorous Motion	~60 secs
	Still Air	~60 mins
Temperature	Range	0 to 70 ^o C
	Accuracy	±0.2 ^o C
Enclosure	Dimensions	130 x 60 x 30 mm
	Material	Black ABS NOT waterproof

* capable of measuring over 90% humidity for short periods

Each EL001 and EL026 converter has an address - a number between 1 and 15. If you wish to connect more than one converter to your logger, each converter must have a different address. If you have two converters with the same address, install the software on your computer and then use the **Change converter address** program to change the address of one of the converters.

The sensor must be situated away from direct contact with water and away from sunlight. Temporary exposure to either is unlikely to damage the unit, but the unit will give incorrect readings while it remains exposed.

The sensor can be attached to the wall either using adhesive foam, or by removing the cover and using two screws to attach the unit to the wall.

3.4.5 EL037 voltage and 4-20mA converter

The EL037 has four inputs. It also has an external power input: this can be used to supply power (perhaps 12 or 24 V, depending on requirements) to the sensors.

Range		
±2.5 V	15 bits + sign (40 uV per LSB)	±0.3%
±10 V	15 bits + sign (0.15 mV per LSB)	±0.5%
4-20 mA	15 bits (0.4 uA per LSB)	±0.4%

Each input can be configured using jumpers to accept either 2.5 V, 10 V or 4-20 mA. It can be configured for other voltage ranges and for resistance measurement with minor component changes. The following diagram shows how to set a jumper to select the input type for a channel.

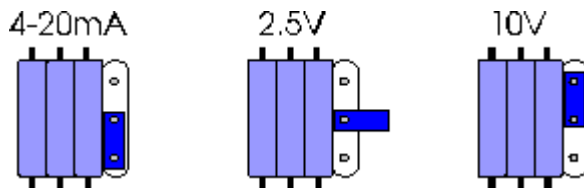

When measuring voltages, or for measuring 4-20 mA with the transmitter supplying the loop current, the input is connected between IN and GND. The PWR connector can be used to supply power to the transmitter:

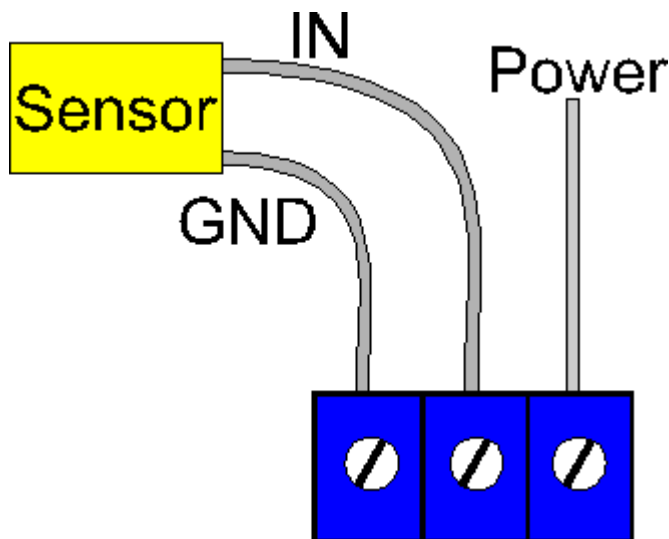

When measuring 4-20 mA with the EL037 supplying loop current, the transmitter should be connected like this:

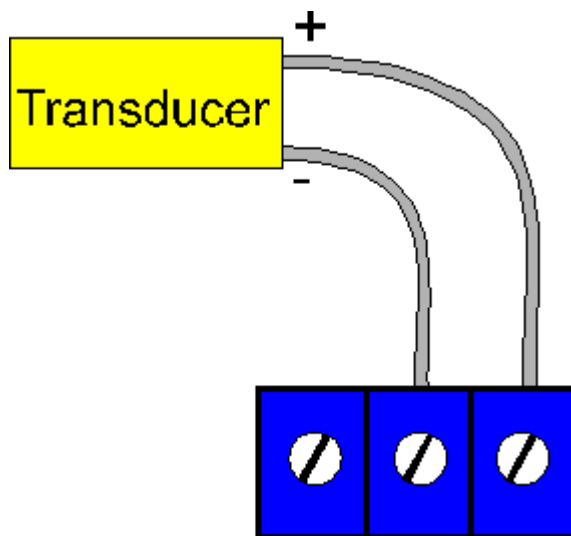

NOTE: only 100 mA is available for the whole network. When using the PWR connector to supply power to the transmitter or to supply the loop current, it may be necessary to use the external power input.

3.4.6 EL040 current monitor converter

The EL040 current monitor converter is intended for use with the TA011 current clamp or similar current transformers. These are designed for AC current measurement. .

The EL040 is a three channel device capable of monitoring three current transformers at the same time (the current monitoring kit comes complete with 3 current clamps.).

Current transformers require no power and are available in a wide variety of formats, from 200 A clamp-on units to 5000 A fixed-core transformers. These devices typically generate an AC signal of 1 mV for each ampere flowing through a cable. The EL040 allows these currents to be easily measured using the EnviroMon system.

Specifications

Number of Channels	3
Sensor required	TA011 current clamp or another suitable current transformer
Max input voltage	1 V AC RMS
Input impedance	> 1 M Ω
Frequency range	20 Hz to 1 kHz
Accuracy	$\pm 1\%$ (0 to 200 mV) $\pm 2.5\%$ (200 mV to 1 V)
Operating temperature	-20 ^o C to 70 ^o C
Input connector	4mm banana plug

Connections

Most current transformers are fitted with 4 mm banana plugs, so that they are suitable for use with multimeters. Connect the banana plugs on the current transformer into the banana sockets on the EL040. The polarity is not important. The current clamp should be clipped round a single core of the mains cable. It will not give correct readings if live, neutral and earth wires all pass through the current clamp.

Safety note: Current transformers are intended to simply clip round a mains cable. It is not necessary to make an electrical connection to the cable, and doing so may be dangerous. If you wish to work on uninsulated high-voltage cables, please check the suitability of the current transformer for this use.

3.4.7 EL041 thermocouple converter

The EL041 thermocouple converter is a 4 channel unit, intended for use with any conventional thermocouple of type B, E, J, K, N, R, S or T with a 'mini-thermocouple' connector. The EL041 is cold junction compensated for all types of thermocouple. The compensation can also be switched off, for measuring a ± 60 mV input signal.

Specifications

Number of channels	4
Thermocouples supported	B, E, J, K, N, R, S, T or mV SE0xx Thermocouples
Voltage input range	± 60 mV
Resolution	15 bits + sign bit
Accuracy	Thermocouples: $\pm(0.5^{\circ}\text{C} + 0.3\%$ of type K reading) Millivolts: $\pm 0.3\%$
Conversion time	1 second
Overload protection	± 10 V
Input connector	Mini-thermocouple plugs
PC connection	via Enviromon Network
Operating temperature	0 to 70°C (20 to 30°C for quoted accuracy)
Operating humidity	25 to 75%RH

Note: The EL041 is designed to work only with the EL005 logger.

3.5 Alarm Devices

3.5.1 EL006 remote alarm

The EL006 remote alarm is useful when the room where the logger is located is not often occupied. One or more remote alarms can be connected at any place along the network where staff will hear the audible alarm

The remote alarm looks like a standard converter, but has only the network sockets. It is connected to the system using two network extension cables.

3.5.2 EL018 dialler adapter and battery backup

The EnviroMon system is designed to operate with the Gardiner Technology Gardtec dialler or the Menvier Security SD1 speech dialler.

The dialler can be programmed with a list of emergency telephone numbers. When there is a problem, the dialler calls each of the telephone numbers in turn until someone answers, then it gives a message saying that there is a problem.

The dialler behaves in the same way as any normal extension and does not affect the normal operation of the telephone.

The dialler adapter serves three purposes:

- Controls the dialler
- Provides power for the dialler and for the system
- Is capable of providing battery backup for much longer periods than the logger's internal backup

The dialler adapter is supplied in a grey plastic box with a clear lid. The box has a large hole each side for cables. There is space for a 1.2 Ah battery inside the box: this will provide backup for 12 to 24 hours, depending on the configuration. Alternatively the unit can be connected to a car battery outside the box: this could provide backup for many days.

Safety note: When using an 1.2 Ah battery inside the box, do not attempt to seal the cable holes, as this may cause an explosive build-up of gases inside the box.

The speech dialler can give three messages for different types of problem as follows:

- A - temperature out of range or sensor fail
- B - mains fail for more than 5 minutes
- C - network fail for more than five minutes.

There is a separate wire between the adapter and the dialler for each problem: if you do not wish to have calls made about a problem, leave the wire unconnected.

There is a red light for each problem: the light is turned on when the problem is detected. There are two green lights: one for mains power and one for battery power. When the mains is on the battery is kept charged up continuously and both the mains and the battery lights remain on.

There are three groups of screw terminals on the EL018: these serve the following purpose:

- Backup battery
- Speech dialler
- Network (you can use the phone connector sockets if you prefer).

When using the EL018 with the EL005 logger, plug a mains adapter into both the EL005 and the EL018.

The connectors and lights on the EL018 are laid out as follows:

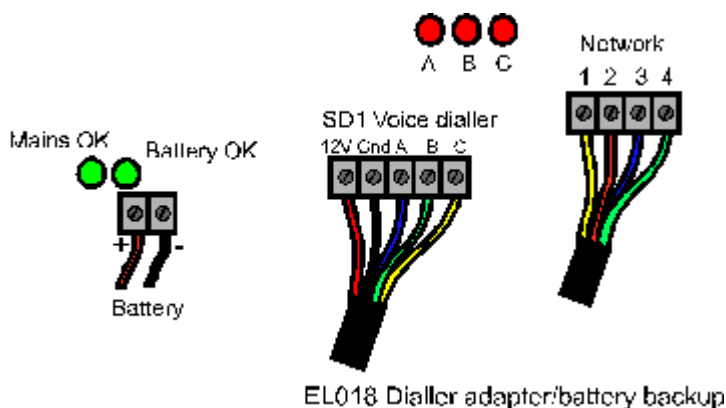

When it is wired into the system, it will look like this:

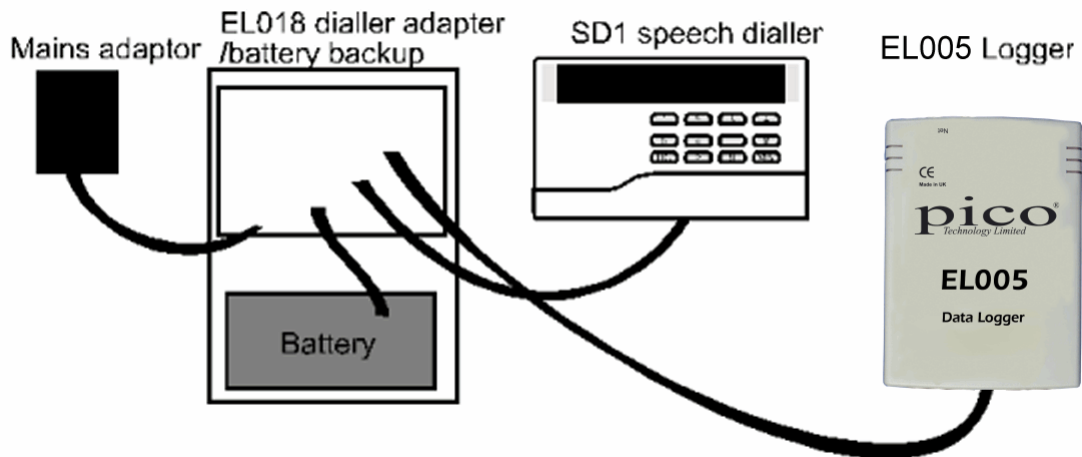

3.6 Package systems

3.6.1 Current monitoring kit



The current monitoring kit provides a complete solution to measuring three channels of mains current. This could typically be applied to measuring and balancing three-phase supplies or monitoring the increase / decrease in current drawn from mechanical equipment to aid maintenance schedules.

Kit contents

- 1 x EL005 data logger
- 1 x EL040 monitor converter
- 3 x TA011 current clamps
- 1 x EL003 sensor cable (5 m)
- 1 x power supply
- PC software, cables and manuals

4 Getting started

4.1 Installation of a package system

Connect the current monitoring kit together as follows:

1. **Logger to PC**

Connect the EL005 logger to either of the 9-pin D9 serial ports on the computer using the serial cable

2. **Power**

Plug the mains adapter into a mains socket and then plug the DC connector into the logger. A red light should be illuminated on the unit to verify power has been applied

3. **Network**

Connect the EL040 current monitor converter to the EL005 data logger using the EL003 network cable provided. Check that the red light on the converter is flashing to signal a successful network connection

4. **Sensor**

Attach the 4mm banana plugs from the TA011 current clamps into the EL040 current monitor converter.

You are now ready to install the software, then configure the system

4.2 General installation instructions

4.2.1 Identifying the equipment

You will need the following equipment in order to set up a simple test system:

Computer

The computer must be running Windows 95, 98, ME, NT, 2000 or XP. It must have at least one spare serial port.

Serial port

This is a D-shaped male (with pins sticking out) connector on the back of your computer. The plug can have either 9 or 25 pins: if the plug has 25 pins, you will need an adapter. Most computers have only two serial ports - these are called COM1 and COM2. The ports are not normally labelled, but it is usually safe to experiment to find out which is which.

Serial cable

This is a cream-coloured round cable about 2 metres long with a D-shaped 9-pin connector at each end. The male end (the one with pins sticking out) connects to the logger: the female end attaches to the serial port on the computer.

Mains adapter

This is a black plastic block with a built-in mains plug. It has a black two-core cable that goes to a round DC connector, which plugs into the power socket on the logger.

Logger

The logger collects data and stores it until the PC is ready to receive it. The logger comes in a black box with a display and has the following connectors:

- Round DC connector to mains adapter
- D9 female connector to computer
- Two square telephone-style connectors for network

The two network connectors are joined internally, so you can use either socket, or both.

Network cable

This is a white oval cable about five metres long with telephone-style connectors at both ends. Note that network connectors are slightly larger than sensor connectors. Network connectors have six slots in the end, although only the middle four slots are fitted with gold contacts.

Converter

The converter changes the electrical signal from a sensor into a digital message that is transmitted to the logger. There are several types of converter: the most common is the EL001 temperature converter. The EL001 is a black plastic 'soap box' with two square network sockets at one end and three sensor sockets at the other end.

Each converter has an 'address' - a number between 1 and 15, which is used to identify the converter. The address appears on the top left hand corner of the converter.

Temperature sensor

The EL015 temperature sensor is a stainless steel tube, 6mm diameter and 50mm long. It is fitted with a white, oval cable about five metres long, with a telephone style connector on the other end.

The sensor connector is slightly smaller than the network connector: it has four small slots, each containing a gold contact- unlike the network connector, which has an empty slot at each end.

There is a clear plastic label on the cable next to the connector: this specifies the type of sensor, the batch number and the sensor number. The batch number and serial number are unique for each sensor, and can be used as a reference number for calibration information.

Now go to [Connecting up the equipment](#).

4.2.2 Connecting up the equipment

To gain experience with the system, we recommend connecting up a small system, with just a single converter, next to the computer. Once you are confident that you understand how it works, you can install the complete system in the correct place.

1. Logger to PC

Connect the logger to either of the 9-pin D9 serial ports on the computer using the serial cable

2. Power

Plug the mains adapter into a mains socket and then plug the DC connector into the logger

3. Network

Plug one end of the network cable into the logger, then plug the other end into one of the network sockets (labelled 'Net') on the converter

4. Sensor

Plug the sensor into the first sensor socket on the converter

Now go to [installing the software](#).

4.2.3 Installing the software

Installing under Windows 95, 98, ME, NT, 2000 or XP:

1. Insert the Pico CD into your CD-ROM drive
2. If Autorun is enabled the CD will startup automatically. If so, go to step 5
3. Click the **Start** button and select **Run...**
4. Type `d:\index` (where 'd:' is your CD-ROM drive)
5. Hit the `<Enter>` key
6. Click the **Install Application Software** button
7. The program will guide you through the installation

To run the software:

1. Click the **Start** button
2. Select **Programs**
3. Select **Pico Technology**
4. Select **EnviroMon**

4.2.4 Setting converter addresses

Note: You can skip this section if you have only one converter; for example, if you are using a starter kit.

If you are planning to use more than one converter, each converter must have a different address. Most converters have the address written on the top right hand corner. If you have two converters with the same address, you must change the converter addresses so that each converter has a unique address BEFORE you connect up the complete network. To do this:

1. Install the software on your computer
2. Connect the logger to a serial port on the computer using the cable provided
3. Plug the power supply into the mains and connect it to the logger
4. Connect the first converter to the logger using the network cable
5. Click the **Start** button (Windows 95 and above)
6. Select **Programs**
7. Select **Pico Technology**
8. Select **Set Converter Address**
9. Select the serial port (eg COM2) to which you connected the logger
10. Select the address that you wish to use for this converter
11. Click the **Program** button
12. Wait until the computer reports that the converter has been programmed
13. For EL026 humidity converters, see [Calibrating humidity converters](#)
14. Unplug the converter
15. Repeat this procedure for each converter

4.2.5 Calibrating humidity converters

If you are not using humidity converters, you can skip this section.

The EnviroMon humidity measuring system is made up of two parts: the EL026 converter and the EL030 sensor. These can be connected together using a cable up to 25 metres long.

The EL030 sensor has some calibration information written on the base: before you use an EL026 and EL030 together, you should use the Converter Address program to write this calibration information into the EL026.

To do this, you should connect up the equipment and run the **Change converter address** program as per the instructions for setting the converter address, then you should proceed as follows:

1. Select the serial port to which you have connected the logger (eg COM2)
2. Select the address that you wish to use for this converter
3. Click the **Program** button
4. Wait until the computer reports that the converter has been programmed
5. The computer will turn on the **Calibration** button: click this button now
6. Enter the lowest figure (normally about 0%) into the first box
7. Enter the highest figure (normally about 100%) into the second box
8. Click the **Program** button
9. Wait until the computer reports that the converter has been programmed
10. Unplug the converter

4.2.6 Configuring the system

To run the software:

1. Click the **Start** button
2. Select **Programs**
3. Select **Pico Technology**
4. Select **EnviroMon**

The first time you start up the software, it will offer you three choices:

1. A look at the overview section of the help file
2. A guided tour of the configuration
3. Start the configuration

If you select the guided tour, the computer will take you through the basics of setting up the system, explaining what each step involves. Alternatively, you can follow the instructions below.

If you are not in the **Configuration control panel** already:

1. Select **Settings** from the main menu
2. Select **Configuration** from the **Settings** menu

You should now be at the **Configuration control panel**. If you have already configured the system, and wish to start again:

1. Click on **Reset**
2. When the computer asks you to confirm, click on **Clear**

Once you are back at the **Configuration control panel**, it is time to set the sampling rate:

1. Click on **General**
2. Click on **Sampling**
3. Set the **Minutes per Reading** field to the required value
4. Click **OK**
5. Click **OK**

Now we find out what equipment is connected.

1. Click on **Equipment**
2. Set the serial port field to the one to which the logger is connected (eg COM2)
3. Click on **Converters**
4. Click on **Auto-configure**
5. A box will appear and will show you the status of the auto-configure process. After a few seconds, this will disappear and the computer should display the details of your converter in the large box.
6. Click on **OK**
7. Click on **OK**

Now we need to specify where the sensors are to be located, by giving names to them.

1. Click on **Locations**
2. Click on **Add**
3. Type in a name for your sensor into the **Name** field
4. Select the channel that you wish to use (channel 1 on your converter)
5. Select the type of sensor, for example EL015.
6. Click on **OK**

If you are planning on using the current monitoring kit, select **EL040 - Amps** as the sensor type

Now we need to program the calibration information into the logger.

1. Click on **Program**
2. A box will appear and will show you the status of the auto-configure process. After a few seconds, this will disappear if the programming completed successfully.

The configuration is complete: we must exit from the program now so that the changes will take effect.

1. Click on **Exit**
2. Click on **OK**

You will need to restart the software to display the readings.

4.2.7 Looking at current readings

To look at the current readings, you should start the EnviroMon program:

1. Click the **Start** button
2. Select **Programs**
3. Select **Pico Technology**
4. Select **EnviroMon**

If it is more than a few minutes since you last ran the software, the computer will display a box to show you how many readings it has transferred from the logger.

The computer next displays the monitor window - a list of temperatures for each sensor.

When the monitor window is active, you may find the following features useful:

- Select **Settings** then **Configuration** to make changes to the configuration
- Select **View...** then another option to view stored data
- Select **Help** then **Contents** to get the help file contents page
- Select **Help** then **Index** to get an index for the help file
- Select **Help** then **Guided tour** for a guided tour of the functions used in day-to-day operation

4.2.8 Displaying a graph

To look at the graph, you first need to display the monitor window.

Next you should take the following steps:

1. Select **View** from the main menu
2. Select **Graph** from the **View** menu

The computer will display a graph showing all data recorded so far.

5 Display options

EnviroMon can display data in five different formats, corresponding to the following five window types:

- **Monitor window**
Shows current temperatures and alarm state
- **Graph window**
Shows the temperature over a period of time
- **Summary window**
Shows the statistics and error information for a period
- **Spreadsheet window**
Shows detailed temperature information in a format which can be copied to a clipboard
- **Event window**
Shows each of the occasions on which an out of range or sensor fail has occurred

The monitor window is displayed when you start the program; the other windows can be selected from the **View** menu.



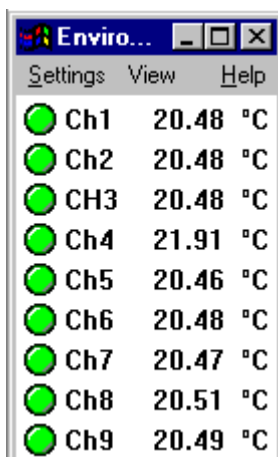

5.1 Monitor window

When you start EnviroMon, the computer displays the **Monitor window**, which looks like this:



This window has a menu which gives access to other windows and a line of information for each active sensor.

At the left of each line is an indicator lamp which changes colour depending of the state of the sensor:

-  - sensor value is within range
-  - sensor value is currently out of range, but has not been out of range long enough to raise an alarm
-  - sensor is in an alarm state: use the mouse to click on the lamp: this will cancel the alarm
-  - sensor is an alarm state, but the alarm has been cancelled

Next to each lamp is the sensor name and the current temperature. The temperature is updated every few seconds.

The **Monitor window** has a menu: you can use the menu to

- Select what sensors appear on the monitor window
- Activate other windows
- Configure the system
- Specify various options, including colour and sound options

When the **Monitor window** is running, you can find out about the menu by pointing at a menu option, then pressing the F1 key. To find out more now, click on menu.

If you minimise the monitor window, the computer will display an icon which shows whether there are any warnings or alarms:







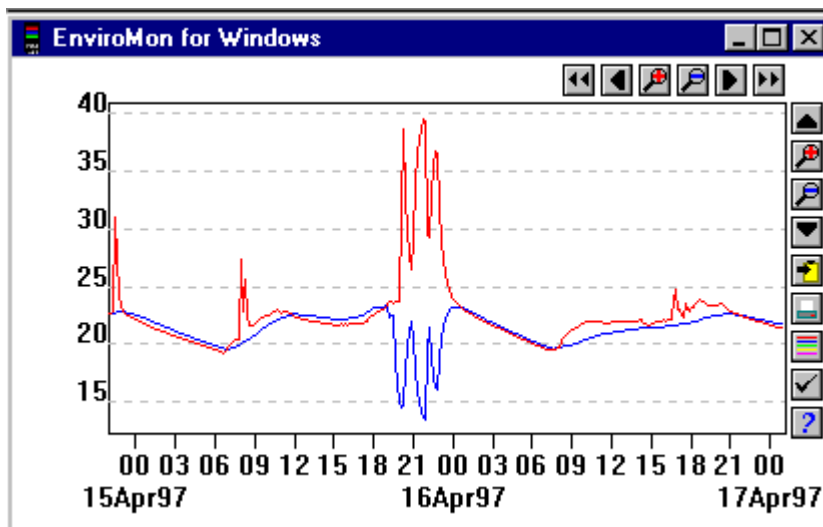

If an alarm occurs, you can then double-click on the icon to restore the **Monitor window**.

5.2 Graph window





When you select **Graph** from the **View** menu, the computer opens a new window like this:









There are a number of buttons in the top right of the screen. The group of horizontal buttons selects what time interval is displayed:

-  - **Scroll left**
Move to the left by a whole display (earlier)
-  - **Scroll quarter left**
Move a quarter display left (earlier)
-  - **Expand horizontal axis**
Magnify the middle half of the display to fill the whole width
-  - **Shrink vertical axis**
Shrink the current display to half size, so that more is displayed before and after
-  - **Scroll quarter right**
Move a quarter display right (later)
-  - **Scroll right**
Move a whole display right (later)

The upper group of vertical buttons controls the vertical range displayed: note that if you use these controls to change the vertical range, auto-scaling is turned off. Use the options button (see below) to turn auto-scaling back on again.

-  - **Scroll up**
Move a whole display up
-  - **Expand vertical axis**
Magnify the middle half of the display to fill the whole height
-  - **Shrink vertical axis**
Shrink the current display height to half size, so that more is displayed above and below
-  - **Scroll down**
Move a whole display down

The remaining vertical controls are:

-  - **Select today**
Set the time axis to run from midnight yesterday to midnight today
-  - **Select this week**
Set the time axis to run from the first to the last day of this week. Note: By default, the first day of the week is Monday. The [FirstDayOfWeek](#) preference can be used to specify a different day
-  - **Copy to clipboard**
Copy the graph to the clipboard
-  - **Print contents of window**
Print the graph
-  - **Select channels**
Select the channels to display on the graph
-  - **Window options**
Specify the options for the graph
-  - **Help**
Go straight to help information specific to the graph window



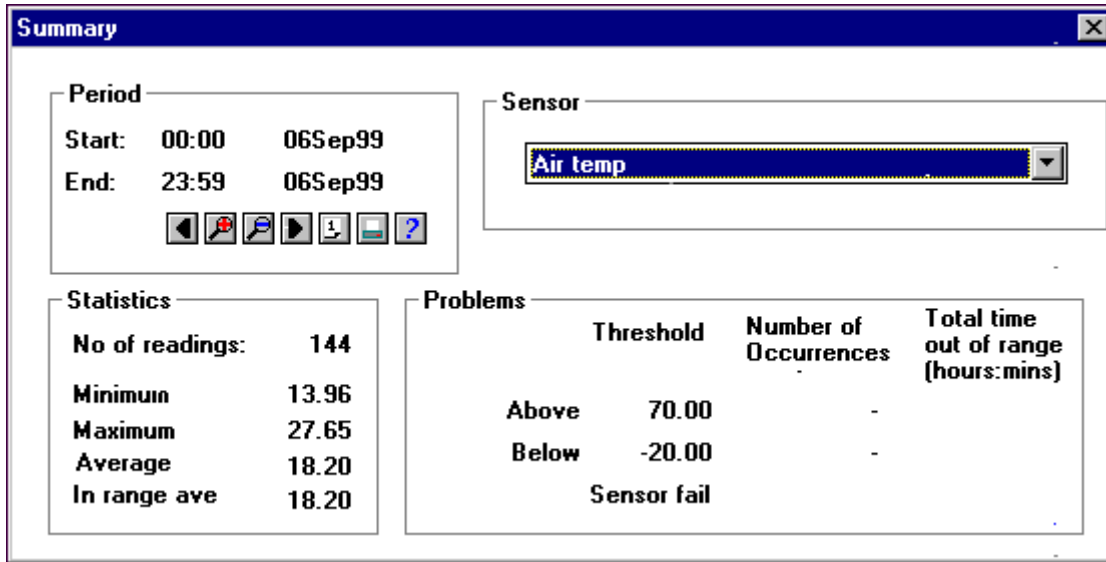

If you move the mouse cursor onto the graph part of the screen, the computer will display the temperature and time at the current cursor position.

5.3 Summary window



When you select **Summary** from the **View** menu, the computer opens a new window like this:



The **Period** section of the window contains the time interval for the summary. You can either type in a start and end time and date, or you can use the buttons to alter the range. The controls are as follows:

-  - **Earlier**
Move a quarter period earlier
-  - **Expand horizontal axis**
Halve the current period
-  - **Shrink horizontal axis**
Use twice the current period
-  - **Later**
Move a quarter period later

The **Sensor** area of the window shows which sensor is to be displayed in the summary: if you select a different sensor, the display will be updated.

-  - **Print contents of window**
Prints out a summary for all sensors for the current period
-  - **Help**
Go straight to help information specific to the graph window

The **Statistics** section of the window shows the number of readings during the period for this parameter, and the minimum, maximum and average for the period.

If the readings go out of range during the period, the computer displays a separate figure for the average of the in-range values, ie it excludes the values that are out of range from the average calculation). This is useful if the parameter only goes out of range under known circumstances, for example during a defrost cycle on a chiller. The in-range average appears in brackets on the printed report.

The **Problems** section of the window shows the number of times and total time the value has been out of range. There are separate figures for above range, below range and

sensor fail.

5.4 Spreadsheet window

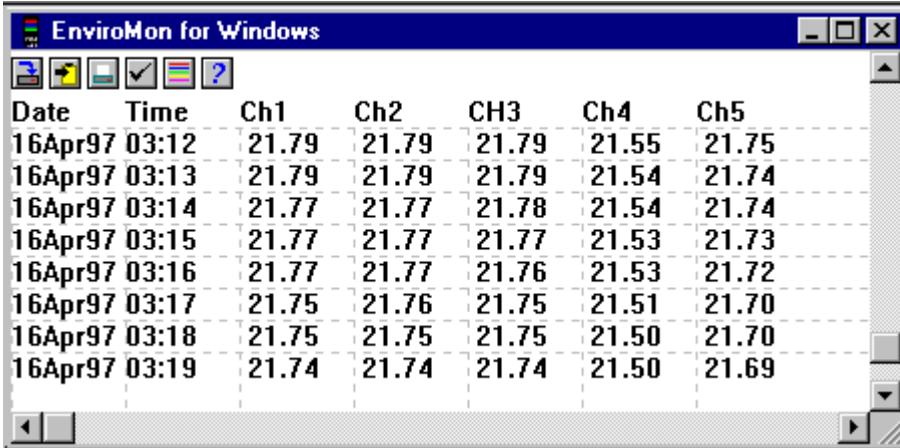

When you select **Spreadsheet** from the **View** menu, the computer opens a new window like this:









Date	Time	Ch1	Ch2	CH3	Ch4	Ch5
16Apr97	03:12	21.79	21.79	21.79	21.55	21.75
16Apr97	03:13	21.79	21.79	21.79	21.54	21.74
16Apr97	03:14	21.77	21.77	21.78	21.54	21.74
16Apr97	03:15	21.77	21.77	21.77	21.53	21.73
16Apr97	03:16	21.77	21.77	21.76	21.53	21.72
16Apr97	03:17	21.75	21.76	21.75	21.51	21.70
16Apr97	03:18	21.75	21.75	21.75	21.50	21.70
16Apr97	03:19	21.74	21.74	21.74	21.50	21.69

There is one line for each reading. The first two columns show the time and date: the remaining columns show the selected sensors. The scroll bar on the right selects the range of times to display.

If you select a range of readings, you can use the following buttons:

-  - **Write to disk**
Write the readings to a disk file
-  - **Copy to clipboard**
Write the readings to the clipboard

The following options buttons are available:

-  - **Print contents of window**
Prints out a summary for all sensors for the current period
- **Window options**
Here you can specify whether to display individual readings, or average, minimum and maximum for a period
-  - **Select channels**
Opens the **Select parameters** dialog box
-  - **Select today**
-  - **Select this week**
-  - **Earlier**
Move a quarter period earlier
-  - **Later**
Move a quarter period later
-  - **Help**
Go straight to help information specific to the spreadsheet window

You can select a range in one of three ways.

If all of the readings that you want to select are on the screen:

1. Point the mouse at the first reading
2. Click and hold down the left mouse button
3. Drag the mouse to the last reading: the selected readings will be highlighted as you go
4. Release the left mouse button

If the readings are a long way apart:

1. Point the mouse at first reading
2. Click the left mouse button: the first reading will be highlighted
3. Scroll down to the last reading
4. Point at the last reading
5. Press down the shift key and click the left mouse button

If you wish to select all of the readings for one day:

1. Point the mouse at any reading during the required day
2. Click the left mouse button: the reading will be highlighted
3. Click the  button

5.5 Events window



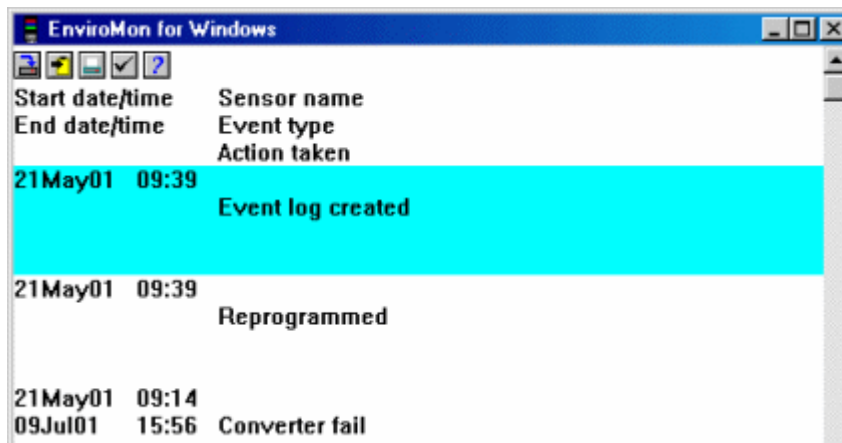

When you select **Events** from the **View** menu, the computer opens a new window like this:



There are two or four lines of text for each event. At the left is the start and end date/time: the end date/time is omitted if the fault is still active. Next to these are the sensor name and a description of the fault. If **Show action taken** is enabled, the action taken will be displayed beneath the fault description.

The scroll bar on the right selects the range of times to display.

To select a range of readings, you can use the following buttons:

-  - **Write to disk**
Write the events to a file on disk
-  - **Copy to clipboard**
Write the events to the clipboard
-  - **Print the contents of window**
Print the events
-  - **Window options**
Specify the options for the events
-  - **Help**
Go straight to help information specific to the events window

You can select a range in one of two ways.

If all of the readings that you want to select are on the screen:

1. Point the mouse at the first event
2. Press and hold down the left mouse button
3. Drag the mouse to the last event: the selected events will be highlighted as you go
4. Release the left mouse button

If the events are a long way apart:

1. Point the mouse at first event
2. Click the left mouse button: the first event will be highlighted
3. Scroll down to the last event
4. Point at the last event
5. Press down the shift key and click the left mouse button

To edit the notes on action taken for an event, point at the event with the mouse cursor and double-click the left mouse button.

6 Main settings

The **Configuration control panel** is the main interface for configuring the system. For a first-time installation, you should use each of the buttons in the sequence that they appear. If you later wish to make adjustments to the system, you can go straight to the function that you wish to change, then use the **Program** button to write the new configuration to the logger. Note: Before you use the **Program** button or the **Auto-configure** button in the **Converters** dialog box (part of **Loggers**), the logger must be connected.

General

This button leads to the **General configuration info** panel: there are buttons to set the sampling interval, temperature units and other system-wide parameters.

Security

This button is necessary only if you wish to restrict access to the configuration parts of the software. Its purpose is to help you define a list of people authorised to use the system.

Equipment

This button works in two modes. In a system with a single data logger, it displays the **Logger** dialog box, allowing you to specify how the logger is connected to the computer. There are also buttons to enter converter information, and details about more advanced logger functions (logger printer, reporting, alarm dialler etc). In a system with multiple data loggers, it displays the **Logger list** dialog box, allowing you to add or edit details for a number of loggers.

Locations

This button displays the **Sensor list** dialog box. As well as displaying a list of the sensors currently in use, it provides options to add or edit sensors. The sensor information includes the sensor name, its address (logger, converter, channel) and the alarm limits for the sensor.

Program

This button writes the configuration information to the logger. The process is automatic: just plug in the logger, then click the button and wait for it to complete.

6.1 General configuration info panel

The **General configuration info** panel is accessed via the **General** button on the **Configuration control panel**. It gives access to a number of dialog boxes that control the overall settings of the system parameters that are not related to a specific logger or sensor.

Sampling

This button gives you access to the **Sampling interval** dialog box which sets the time interval between recorded readings.

Temperature

This button gives access to the **Temperature display** dialog box which selects the units and number of decimal places for temperature measurements.

Alarm

This button gives access to the **Alarm behaviour** dialog box which specifies options (time ranges, repeat interval, etc) for alarm handling.

Site

This button gives access to the **Site information** dialog box which accepts a site name and contact details for maintenance.

Summer time

This button gives access to the **Summer time dates** dialog box which sets the dates for the start and end of summer time. The logger can then automatically put its clock forward or back at the right time.

Directories

This button gives access to the **Data storage** dialog box which accepts directory names for data and backup files, and controls cleanup of old data files.

Note: Changes to the general settings are saved when you click the **OK** button. If you click the **Cancel** button, any changes are discarded.

6.1.1 Sampling interval dialog box

Accessed via the **Sampling** button on the **General configuration info panel**, this dialog box is used to specify when readings are to be recorded.

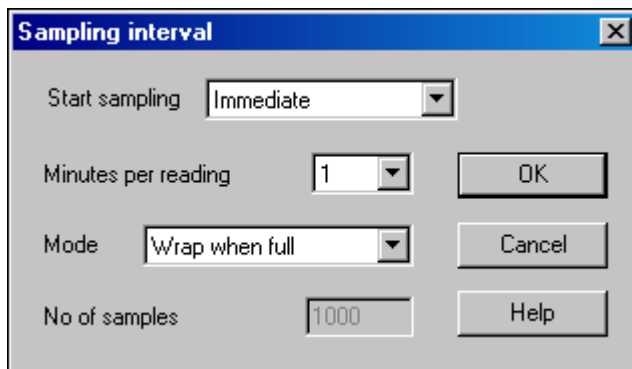
**Minutes per reading**

This is time interval between recorded readings in the logger. The logger measures and displays values from sensors continuously, and then stores the average value at the intervals specified.

Mode

This defines whether to fill the whole of the logger memory with readings and, if so, whether to stop when the logger is full. There are three options, as follows:

- **Wrap when full**
When the logger memory is full, it starts overwriting the oldest readings. This is the correct option when you wish to collect data continuously for long periods, as the logger will then contain the most recent readings at any time
- **Stop when full**
The logger stops saving readings as soon as its memory is full. This is useful if you wish to make sure that you do not lose the readings taken immediately after you start the logger, even if you do not download the information regularly
- **Stop after n samples**
Same as **Stop when full**, but the **No of samples** field below defines the number of readings to collect before stopping

Note: If you use **Stop when full** or **Stop after n samples** modes, you can restart the logger only by disconnecting and reconnecting the mains adapter and battery from the logger, or by re-programming it.

No of samples

This specifies the number of readings to collect before stopping when in **Stop after n samples** mode.

6.1.2 Temperature display

Accessed via the **Temperature** button on the **General configuration info** panel, this dialog box is used to specify the units for temperature measurements and the number of decimal places for measurements. Readings are normally displayed in Celsius, with two decimal places, for example 4.65°C.

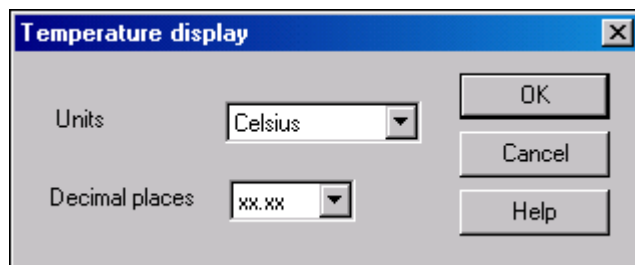

6.1.3 Alarm behaviour

Accessed via the **Alarm** button on the **General configuration info** panel, this dialog box is used to specify the way alarms should be handled by the system.

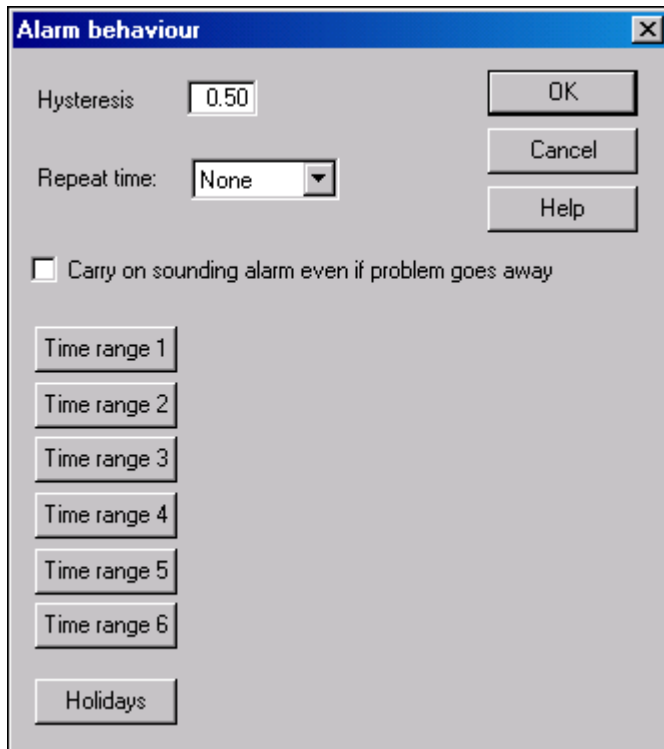

Hysteresis

If a temperature goes out of range, it must go back in range by at least this much before the logger considers that the problem has gone away. For example, if the maximum temperature is 15°C and the hysteresis is 0.5°C, the temperature must drop to 14.5°C before the problem is officially over. If the temperature drops below 15°C but then goes above it again, this will not be treated as a new problem, and so the alarm will not sound again.

Repeat time:

This specifies the time interval, in minutes, that the system must wait after an alarm is acknowledged before activating the alarm again. Set to **None** if no repeat is required.

Carry on sounding alarm even if problem goes away...

If this option is enabled, the alarm will carry on sounding even after the problem goes away. This is useful if the logger is to be left unattended for long periods and you need to know about problems that occurred while the logger was left unattended.

Time range 1..6

Each of these six buttons opens the **Alarm time range** dialog box, which is used to specify a time range during which alarms are to be active - for example, 09:00-17:00 Monday to Friday. There are six time ranges, and a sensor can be associated with any combination of ranges.

Once the details have been specified for a time range, the details will be displayed next to the relevant button.

Holidays

This button opens the **Holiday dates** dialog box, which can be used to specify the dates of up to 12 holidays. Alarm time ranges can be disabled on the specified holidays if required.

6.1.4 Holiday dates

Accessed via the **Holidays** button on the **Alarm behaviour** dialog box, this dialog box is used to specify a list of dates of up to twelve holidays. It is then possible to disable some or all alarm time ranges on the specified holidays. This could be used to disable sensors in processing (rather than storage) areas on days when a processing plant is shut down for a holiday. The dates must be entered in the format DDMmmYY, for example 25Dec04.

Note: it is not necessary to enter any details if you do not need to make special arrangements for holidays.

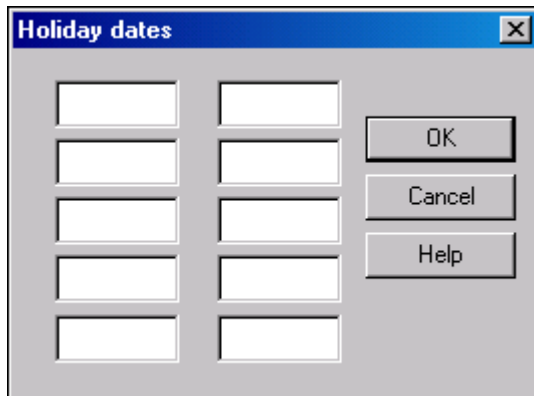

6.1.5 Site information

Accessed via the **Site** button on the **General configuration info** panel, this dialog box is used to specify the site name and maintenance contact. This information appears on reports printed by the computer or by the logger.

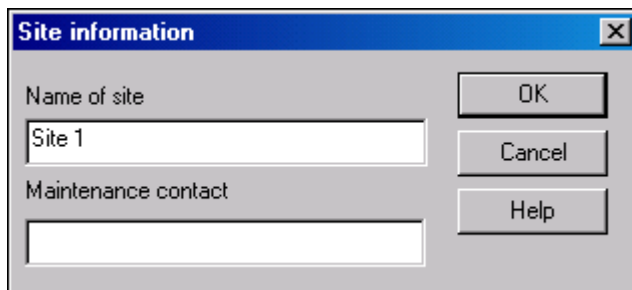
**Name of site**

This is the name of the site where the loggers are to be installed.

Maintenance contract

This is for contact details for maintenance calls: for example, in a freezer monitoring application, it might be the the name and telephone number for the refrigeration engineer.

6.1.6 Summer time dates

This dialog box is accessed via the **Summer time** button on the **General configuration info panel**. In countries that are a long way from the equator, it is normal to adjust the clocks by one hour at the start and end of summer: this has different names in different countries, for example daylight saving time, or British Summer Time.

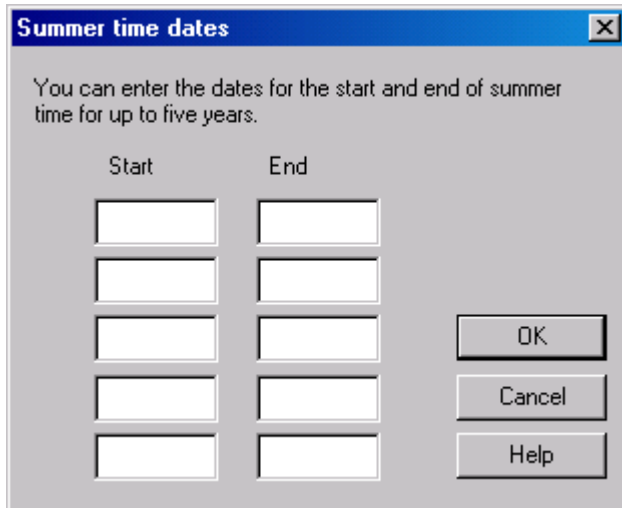

You can enter the start and end times for summer time for the next few years, then the logger will automatically adjust its clock on the specified days.

Note: In the Northern hemisphere, the start and end times will be in pairs, each pair for the same year: in the Southern hemisphere, the start of summer will be October 1997 and the end of summer will be March 1998.

6.1.7 Data storage

Accessed via the **Directories** button on the **General configuration info panel**, this dialog box is used to set the directory names for data files and backup.

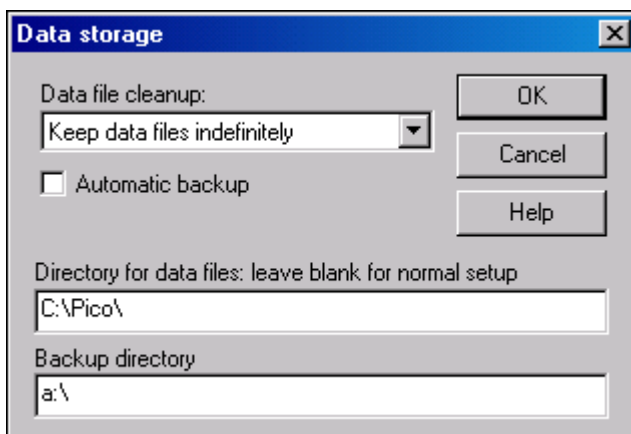

Data file cleanup:

This option can be used to clean up old data files when they are no longer required. The options are:

- **Keep files indefinitely**
- **Delete after one month**
- **Delete after three months**
- **Delete after a year**

Automatic backup

If this option is checked, the program automatically does a backup when you exit from the program. This is probably more suitable for backup to a network drive, than for backup to a diskette. If this option is not checked, you can still do backups using the **Backup** option on the **File** menu.

Directory for data files: leave blank for normal setup

This is a handy feature if you want to save the file containing the data somewhere different (for example, on a network drive so that it can be backed up more easily) or if you wish to operate several loggers independently, each with their own data files. For most applications, it can be left blank: the file containing the data will be stored in the same directory as the EnviroMon program. To specify that data files will be stored on network drive G: in a directory called Pico, type in G:.

Backup directory

This is where files will be copied when a backup takes place. This could be either a diskette drive, or a network directory. If you specify a diskette drive, the computer asks you to insert a blank, formatted diskette before each backup.

6.2 User list dialog box

This dialog box is accessed via the **Security** button on the **Configuration control panel**. This shows details for each of the users who were or are authorised to use the system. An x next to the name indicates that they are no longer active. You can add new users or edit the details of existing users. It is not usually necessary to specify users if only one person will be using the system. If you do add any users, the computer will ask for a password if you select the **Configuration** option from the **Settings** menu.

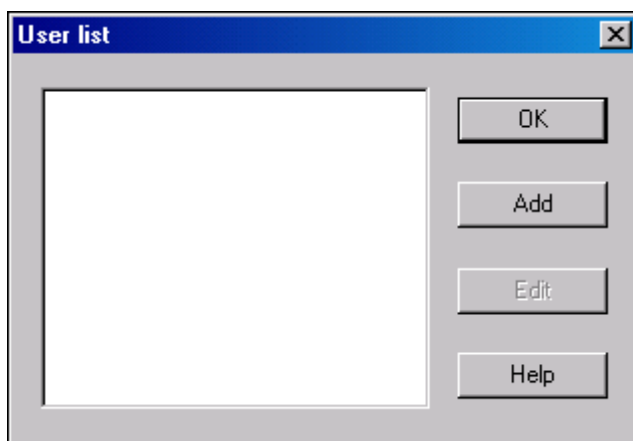
**Add**

Click this button to add a new user

Edit

Click on one of the names in the user list: when the name is highlighted, clicking the **Edit** button will enable you to edit the details for the selected user.

6.2.1 User information

This dialog box is used to enter the details for a new or existing user.

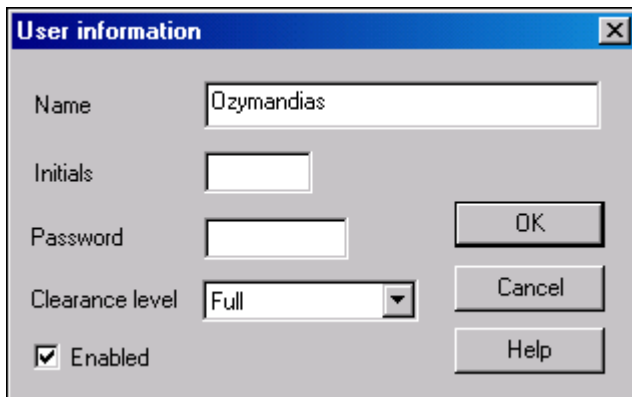

Name

The user's full name.

Initials

The user's initials.

Password

The computer will ask for this each time somebody enters a secure part of the program.

Clearance level

This controls what the user can do. The options are:

- **None**
The user has no access
- **Check**
The user is able to check the current temperatures
- **Note**
The user is able to edit details of events
- **Full**
The user has access to all parts of the system, including configuration

Note: When you add the first user, always select **Full**, otherwise you will not be able to get back into the configuration to change it.

Enabled

It is not possible to remove details of old users, as the system may need to refer to their data at some point in the future: instead, the **Enabled** box should be un-checked. This will remove the person from the list of active users.

6.2.2 Password dialog box

This dialog box appears when it is necessary to confirm a user's security clearance.

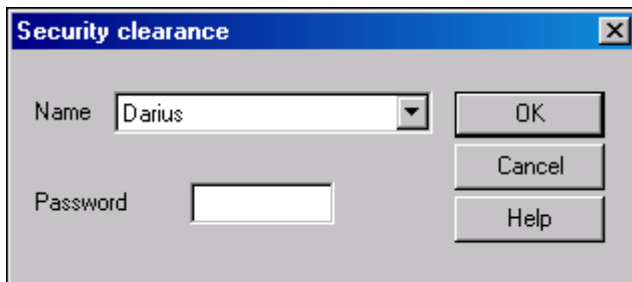

User

This is a list of active users: select your name from the list.

Password

Enter your password here. Note that it will not be displayed as you type.

6.3 Logger dialog box

This dialog box is accessed via the **Equipment** button on the **Configuration control panel**. Its purpose is to enable you to specify how the logger is connected to the computer. There are also buttons which give access to other dialog boxes for entry of converter details and advanced logger functions (printing, etc).

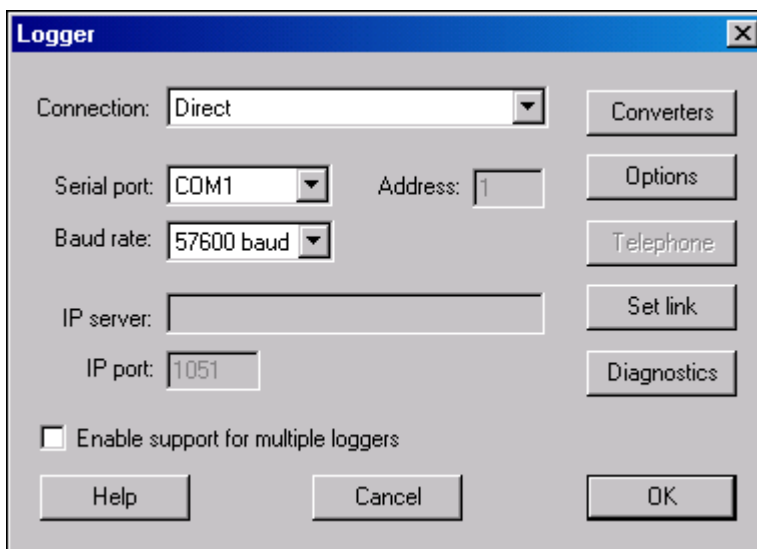

Connection

This option specifies how the logger is connected. The options are:

- **Direct**

The logger is connected directly to the serial port on the computer. You can connect up to nine loggers to the same computer in this way, each to a separate serial port

- **Via telephone + modem**

The logger is at a remote site: the computer uses a modem to make a telephone call to the logger each time you request information. Use the Telephone button to enter details of the link. It is currently only possible to connect one logger by telephone. If you need to access more, you should create a separate configuration for each logger

- **Via radio modem**

The computer is connected to a radio modem, as is the logger. Up to 250 loggers may be connected: each logger must have a separate address

Note: Loggers are supplied programmed for direct connection at 9600 baud: if you change the baud rate option or you wish to use a telephone modem, you should use the Set Link option (see below) to write the link parameters into the logger.

Serial port

This option selects which COM port is to be used.

Address

This option is used on a multi-logger radio link. Each logger has a unique address between 1 and 255: all loggers receive all messages from the computer, but only respond to messages containing their address.

Baud rate

This options specifies the data rate to use for the link to the logger. For a direct link over a short cable, use 57600 baud. For a modem, check the maximum speed that the modem can handle. Note that most modern telephone modems can operate at 57600 baud to the logger, even if they operate at a lower speed over the telephone link.

Enable support for multiple loggers

If you check this box, the computer replaces this dialog box with the **logger list dialog box**: with it, you can add, edit or remove the details for loggers.

Most systems require only a single logger, so the computer normally only presents a dialog box for a single logger. Even if you wish to use multiple loggers, it may be more practical to set up a separate configuration for each logger: that way, the data for each logger is kept separate. This option is only useful if you wish to combine the data from multiple loggers.

Converters

This button is for accessing the **Converter list** dialog box which provides a list of all the converters attached to the logger.

Options

This button gives access to the **Logger Options** dialog box which controls optional equipment that can be connected directly to the logger.

Telephone

This button is for accessing the **Logger dialup options** dialog box which enables you to specify how the dial-up link to the logger is to operate.

Set link

This button programs the connection settings into the logger. Loggers are supplied ready configured for direct connection to the computer, so you do not need to use this option for loggers intended for direct connection. You use this button only when you have changed the connection mode. Connect the logger directly to the port that you have specified, then click the button and wait for it to complete. The programming is automatic.

Note: The logger must be powered down and restarted to activate the new link parameters.

Diagnostics

This button opens up the **Network diagnostics** dialog box. Do not use this option unless directed to do so by Pico Technical Support staff.

6.3.1 Converter list

Accessed via the **Converters** button on the **Logger** dialog box, this dialog box shows a list of converters connected to the selected logger. There are also controls to add or remove converters, or to automatically detect the converters connected to the logger.

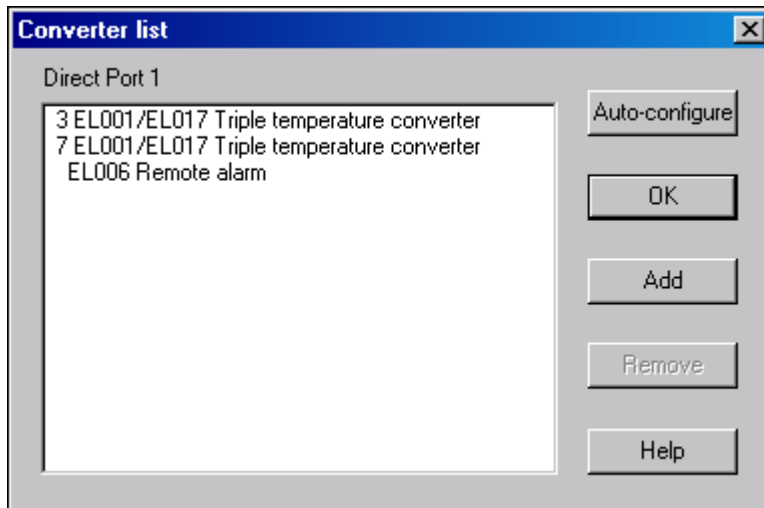

The converter list shows the address and type of each of the converters attached to the logger. Each converter must have a different address. The address is written on the top right corner of the converter. You can use the change converter address program to alter the address of a converter.

It is not necessary to add devices which do not have sensors (for example, the EL006 remote alarm), however the auto-detect function will add them to the list as a check that they are linked correctly to the logger.

If you auto-configure, the computer also displays any alarm devices connected to the network (for example, the EL016, or the EL018).

Note: Each EL016 requires three addresses, so it appears three times in the list.

Auto-configure

Click this button to automatically update the list of converters connected to the logger. Note: the logger must be connected before you select this option.

Add

Click this button to add a new converter to the logger: this will open up the **Addconverter** dialog box.

Remove

Highlight one of the converters in the list, then click this button to remove it.

6.3.2 Add converter

Accessed via the **Add** button on the **Converter list** dialog box, this dialog box is used to enter the details for a new converter.

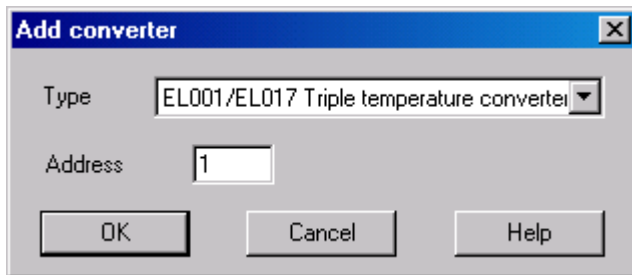
**Type**

The converter type.

Address

This is the number which appears in a box on the top right of the converter. Each converter connected to the logger must have a different address. If you have two converters with the same address, you should use the **Change converter address** program to change the address of one of the converters.

If you make a mistake and enter the same converter twice, the computer will warn you when you try to program the logger.

6.3.3 Logger options

Accessed via the **Options** button on the **Logger** dialog box, this dialog box contains controls for optional equipment connected to the logger.

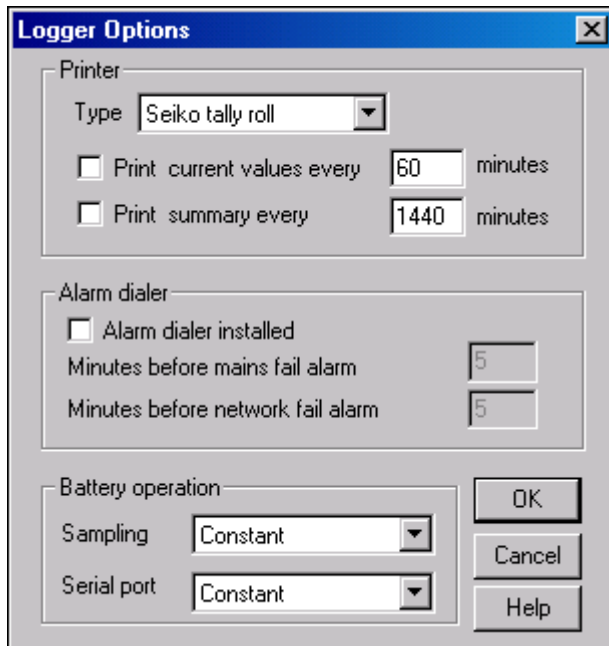

Alarm dialler

The logger can be connected to a dialler unit: when an alarm occurs, the dialler calls a specified number and delivers a recorded message. The dialler connects to the logger using an EL018 dialler interface. In addition to providing a link to the dialler, the EL018 provides the following functions:

- A larger backup battery, with mains charger
- Detection of mains failure
- Detection of network failure (the logger is no longer in contact with the EL018)

On detection of mains or network failure, the interface can be programmed to activate the alarm dialler after a specified period of time.

Battery operation

For the EL005 logger, it is possible to specify what function are to carry on if the mains power fails, in order to conserve battery power.

The sampling can be set in the following manner:

- **Constant**
All the time, even during mains fail
- **Reduced**
At a reduced rate (only one reading for every sample interval)
- **Stopped**
Stop taking readings

The serial port can be set to any of the following three statuses:

- **Constant**
- **Only if DTR**
- **Off**

6.3.4 Logger dial-up options

Accessed via the **Telephone** button on the **Logger** dialog box, this dialog box enables you to specify the details of **1. Connection to logger (routine download)** and **2. Connection from logger (on alarm)** Note: The **Telephone** button is greyed out unless the connection type you have selected in the **Connection:** part of the **Logger** dialog box is **via telephone + modem**.

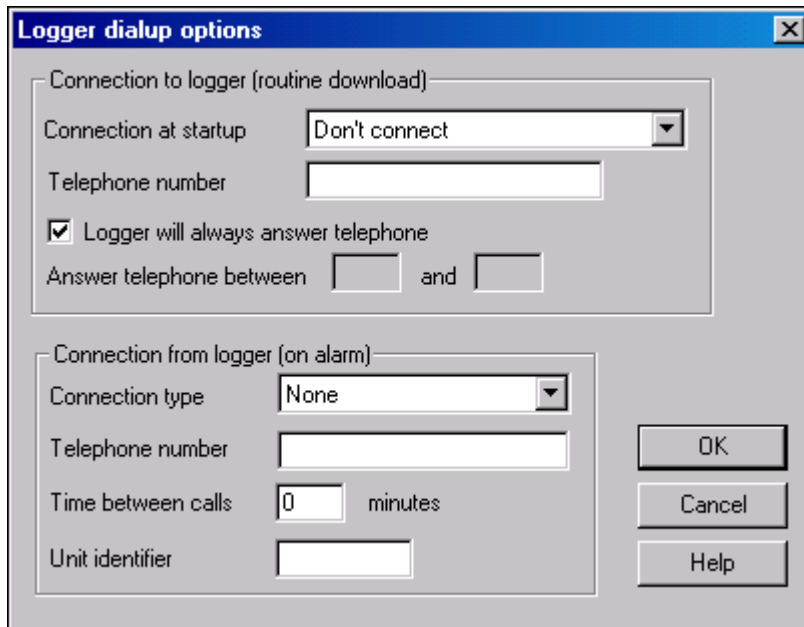

1. Connection to logger (routine download) section of dialog box

Connection at startup

This option specifies whether the computer should start a connection to the logger each time EnviroMon starts up. The options are:

- **Don't connect**
The logger is connected directly to the serial port on the computer. You can connect up to nine loggers to the same computer in this way, each to a separate serial port
- **Disconnect after data transfer**
The computer dials the logger at start-up, but releases the link as soon as all of the new data has been transferred from the logger
- **Remain connected**
The computer is connected to a radio modem, as is the logger. Up to 250 loggers may be connected: each logger must have a separate address

You can manually connect or disconnect at any time: this option simply controls the automatic connection at start-up.

Telephone number

This field is for entering the telephone number that the computer should use to establish a link to the logger.

Logger will always answer telephone

If you check this box, the logger will keep its modem permanently enabled, so that it will always answer an incoming call. This is all right if the logger modem is on a separate phone line.

If you leave this box unchecked, you can specify a time-range during which the modem will answer calls. This means that the modem can be connected to a phone line which is

used for voice calls during the day, but which is enabled for modem access to the logger outside working hours.

Answer telephone between

These two fields are for specifying the time range during which the modem is to be enabled. Note that **Logger will always answer phone** should be left unchecked.

2. Connection from logger (on alarm) section

This section of the dialog box is only available for the EL005 logger.

Connection type

This specifies what type of connection the logger is to establish when an alarm occurs. The options are currently:

- **None**
No message of any type
- **GSM SMS message**
Delivers a text message via a mobile phone (Requires Siemens M20 GSM modem)
- **Pager message**
Delivers a numeric message (the unit identifier) to a pager

Telephone number

The number to call on alarm, for example the telephone number of the GSM phone to deliver an SMS message to.

Time between calls

If the alarm remains active, this option specifies the time, in minutes, between successive alarm calls.

Note: If you do not set this field, you will get a call every sample interval!!!

Unit identifier

If there are several loggers that could raise an alarm, this field can be used to identify which logger is sending the alarm message. It must be a maximum of 8 characters. For pagers, the characters must all be digits.

6.3.5 Network diagnostics

Accessed via the **Diagnostics** button on the **Logger** dialog box, this dialog box shows the network driver version and a summary of errors detected on the network.

You should use this option only if directed by Pico technical support staff to do so.

The **Voltages** button opens the **Voltages** dialog box that shows internal voltages within the logger (EL005 only).

The **Reset** button clears the error counts to zero.

6.3.6 Voltages

Accessed via the **Voltages** button on the **Network diagnostics** dialog box, this dialog box displays a number of voltages within the logger. You should use this button only if directed by Pico technical support staff to do so.

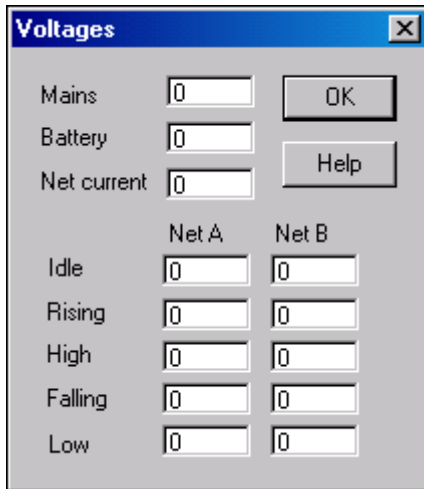

6.3.7 Logger list

This dialog box appears when you tick the check box against **Enable support for multiple loggers** on the **Logger** dialog box. In the left pane is a list of loggers; the buttons on the right enable you to add, edit or remove loggers via multiple **Logger** dialog boxes.

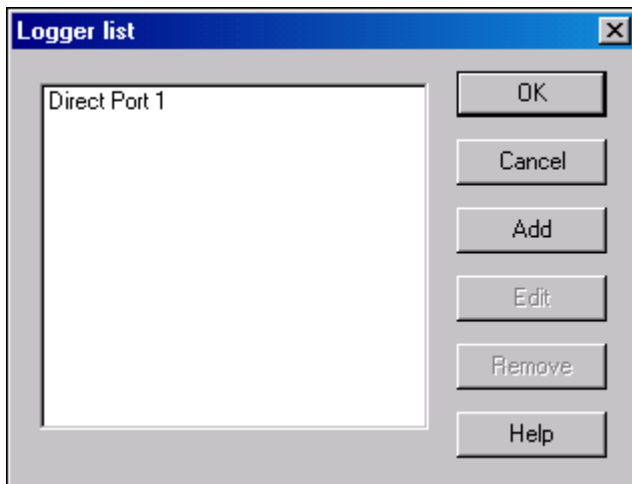

6.4 Sensor list dialog box

Accessed via the **Locations** button on the **Configuration control panel**, this dialog box shows a list of the sensors connected to all loggers and converters in the system. There are also controls to add or edit the details for sensors.

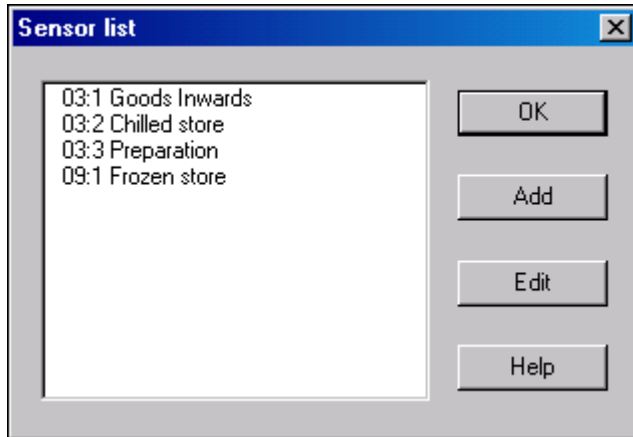

The list pane has a line for each sensor. It shows the address of the sensor (logger, converter and channel) and the sensor name. If the sensor is disabled, an X is displayed before the address.

Add

Click this button to add a new sensor to the list. The **Sensor information** dialog box appears.

Edit

To edit the details of an existing sensor, click on the sensor that you wish to change the details for, so that it is highlighted. Then click the Edit button: the computer will open up a **Sensor information** dialog box.

It is not possible to remove details of previous sensors, as the system may need to refer to their data at some point in the future: instead, the **Enabled** box on the **Sensor information** dialog box for a particular sensor should be un-checked. This will remove the sensor from the list of active sensors.

6.4.1 Sensor information dialog box

Accessed via the **Add** or **Edit** button on the **Sensor list** dialog box, this dialog box is used to add or edit the details for a sensor.

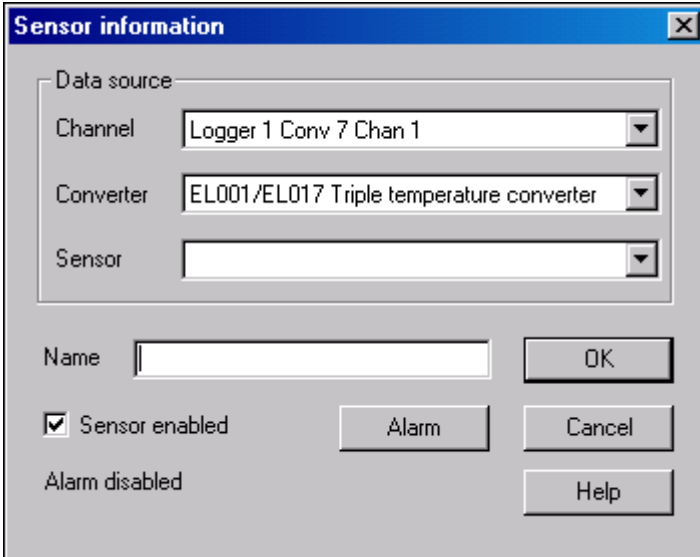

Channel

This drop-down box is for specifying the converter and channel for the sensor. It contains a list of all the current combinations of loggers, converters and channels.

Note: the EL016 appears as three 3-channel converters. The first corresponds to channels 1 to 3, the second corresponds to channels 4 to 6 and the third is channels 7 and 8 (there is no ninth channel).

The logger can measure a number of internal parameters.

Converter

This displays the type of converter that the selected channel belongs to. You cannot change this option.

Sensor

This box is used to select the type of sensor. You should select the channel and conditioner before specifying the sensor type.

Name

This can be any text that you wish to use to describe the sensor. It can be up to 32 characters, but only 16 characters will appear on the display of the logger.

Sensor enabled

Checking the tickbox specifies that the sensor is enabled.

Alarm disabled message

Depends on the settings in the **Sensor alarm** dialog box.

6.4.2 Sensor alarm

Accessed via the **Alarm** button on the **Sensor information** dialog box, this dialog box is used to specify the details for one of the three Alarm time ranges. The alarm for a sensor can be enabled during any combination of these time ranges.

Note: It is not necessary to enter any details if you want to have alarms for all sensors either permanently active or permanently disabled.

When the alarm is enabled for this sensor, the alarm will sound when the value goes out of range or if the sensor or converter fails. There are several options:

- **Never**
The alarm is never enabled for this sensor
- **Always**
The alarm is always enabled
- **During specified time ranges**
Time range 1 - the alarm is enabled only during alarm time range 1
Time ranges 1 & 2 - the alarm is enabled only during alarm time ranges 1 and 2
Other combinations - for example, 1 and 3

See the [Alarm behaviour](#) dialog box for more details about alarm time ranges.

Minimum value

This is the minimum value for the acceptable range of the sensor. Leave this field blank if you do not wish to set a lower value for this sensor.

Maximum value

This is the maximum value for the acceptable range of the sensor. Leave this field blank if you do not wish to set an upper value for this sensor.

Holdoff

The holdoff specifies the period, in minutes, between the value going out of range and the alarm sounding. This is useful if the value occasionally goes out of range for short periods, for example, the temperature of a freezer during a defrost cycle. The holdoff should be set to the minimum time interval required to prevent spurious alarms: it should be set to zero if an immediate alarm is required. It should be at least four times the sampling interval, so with a sample time of five minutes it should be at least 20 minutes.

Hysteresis

If a temperature goes out of range, it must go back in range by at least this much before the logger considers that the problem has gone away. For example, if the maximum temperature is 15°C and the hysteresis is 0.5°C, the temperature must drop to 14.5°C before the problem is officially over. If the temperature drops below 15°C but then goes above it again, this will not be treated as a new problem, and so the alarm will not sound again.

7 Miscellaneous settings

7.1 Preferences

7.1.1 Language dialog box

To access this dialog box, from the **Settings** menu, select **Preferences**, then select **Language**. The following dialog box appears.

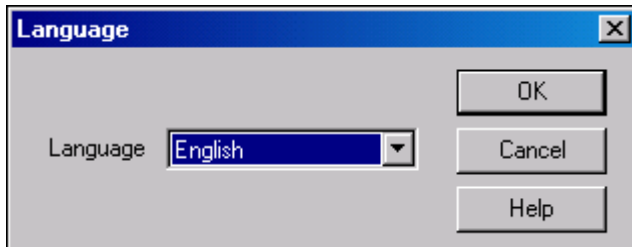

This is used to select the language that EnviroMon and the logger will use.

It is necessary to re-program the logger using the **Program** button on the **Configuration control panel** after changing the language, otherwise the computer will give an 'Incorrect configuration' message every time the program is run.

7.1.2 Colours dialog box

To access this dialog box, from the **Settings** menu, select **Preferences**, then select **Colours**. The following dialog box appears.

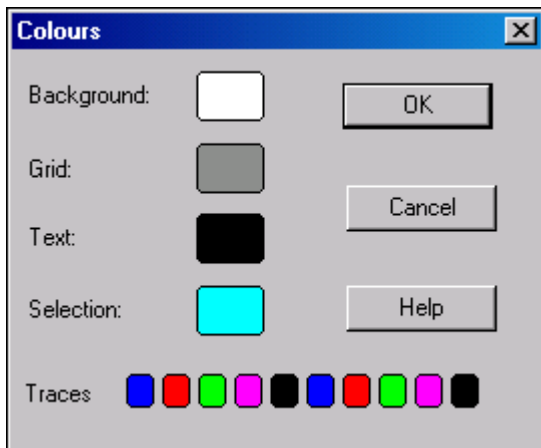

This is used to specify the colours for background, text etc. It applies to graph and spreadsheet windows. To change a colour, click on a box containing a colour. This will open up a standard Windows colour palette. Select the colour you want from here.

Background:

This is the colour for the background on graphs, and for the readings on spreadsheets.

Grid:

This is the colour for the gridlines on graphs.

Text:

This is the colour for text.

Selection:

This is the colour for selected readings on spreadsheets.

Traces

The graph can display up to ten traces: the ten buttons along the bottom of the dialog box are the colours for each trace.

7.1.3 Sounds dialog box

To access this dialog box, from the **Settings** menu, select **Preferences**, then select **Sounds**. The following dialog box appears.

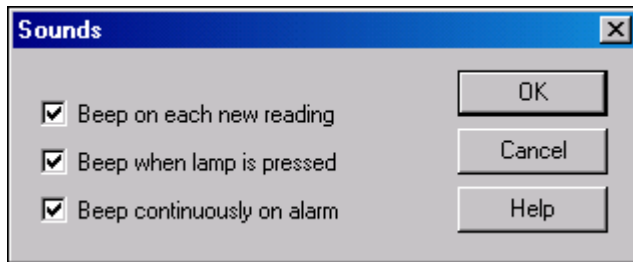

For some events, EnviroMon can make a sound when the event occurs. This dialog box allows you to enable the sounds for each event.

Beep on each new reading

This option is useful if there is a problem and you need to keep a close eye on it. If you select a graph or spreadsheet window, the computer beeps each time a new reading is added to the graph or spreadsheet.

Beep when lamp is pressed

When there is an alarm, the lamp on the monitor window turns red. You can click the mouse button on the lamp to cancel the alarm. When this option is selected, the computer beeps when you click on a lamp, to confirm that it has accepted your request.

Beep continuously on alarm

When this option is enabled, the computer produces a continuous tone while an alarm is active. This is useful if the computer is not in the same room as the logger.

7.2 Monitor

7.2.1 Select parameters dialog box

To access this dialog box, from the **Settings** menu, select **Monitor**, then select **Channels**. The following dialog box appears.

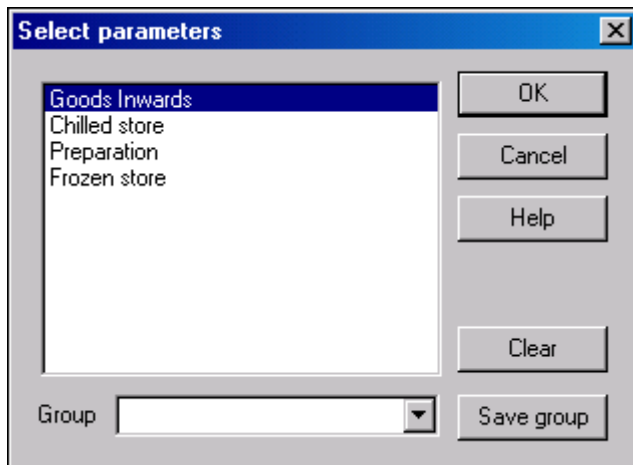

This dialog box is used to select a predefined measurement type. The left pane shows the parameters that are available; the parameters that are highlighted are the active parameters. To select or deselect an item, point at the item with the mouse and double-click on it.

Group

You use this drop-down list box to save and restore a number of named groups of parameters. To save the current parameter selection as a group, type in the group name and click the **Save group** button.

To select a saved group, click on the drop-down arrow and double-click on a group.

To modify an existing group, make the changes to the parameter selection then type in the group name and click **Save group**.

To remove an existing group, de-select all parameters, type in the group name and click **Save group**.

On the **Graph options** dialog box, you can specify that parameters should be divided into a number of separate graphs, one for each group.

7.3 View

7.3.1 Print dialog box

This dialog box appears when you click on  when the **Graph, Summary, Spreadsheet Or Event** window is active.

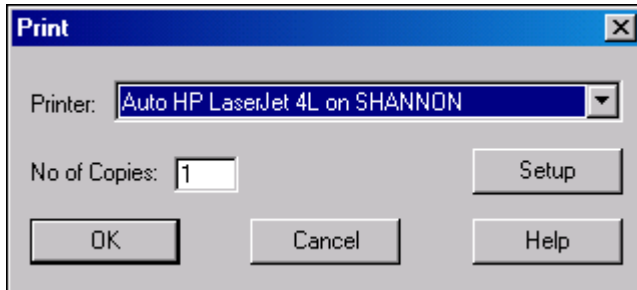

Printer

At the top is a drop-down list box with the name of the default printer. You can select a different printer if you wish.

Setup

Use this button to open a dialog box with setup information specific to the selected printer (for example, to set up for 'portrait' or 'landscape' pages).

Once all the details are correct, click **OK** to start printing.

7.3.2 Graph options dialog box

This dialog box appears when you click on  when the **Graph** window is active.

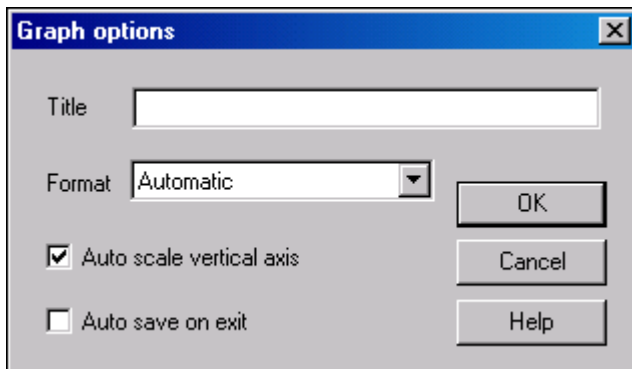

Title

The name you want to give the parameter.

Format

This selects how the parameters will be displayed. The options are:

- Automatic**
Divide according to units
- Separate graphs**
Draw a separate graph for each parameter
- All traces on same graph**
Display all parameters on the same graph
- Graph for each group**
Display a separate graph for each group (as chosen in the [Select parameters](#) dialog box)

Auto scale vertical axis

When this box is checked, the computer automatically adjusts the vertical scale to fit the data that is to be displayed. If you click any of the vertical axis scaling buttons, Auto scale is turned off automatically.

Auto save on exit

When this box is checked, the computer saves the setting when you exit from the graph window.

7.3.3 Spreadsheet options

This dialog box appears when you click on when the **Spreadsheet** window is active.

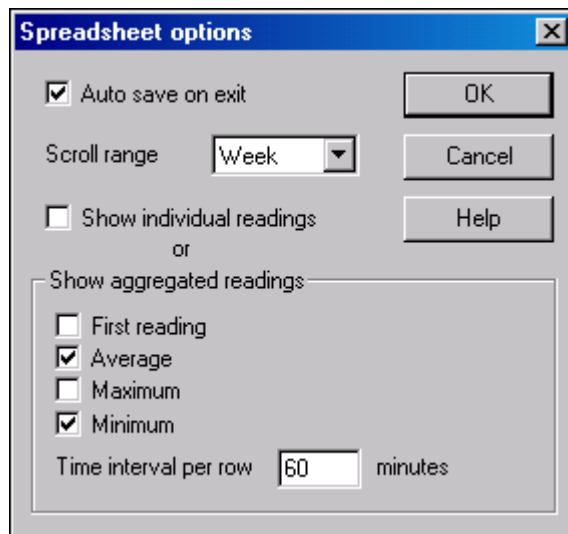
**Auto save on exit**

When this tickbox is checked, all spreadsheet window settings are saved automatically when you close the event window.

Show individual readings

or

Show aggregated readings

When **Show individual readings** is checked, the spreadsheet window shows each individual reading. When it is unchecked, the computer displays results which are aggregates (min/max/ average) of the readings for the time interval specified below, and the controls in the **Show aggregated readings** box are enabled. If you select more than one of average, minimum and maximum, the computer displays the corresponding number of columns for each sensor in the spreadsheet, and adds a heading (max/min/ave) to each column.

Time interval per row

This specifies the time interval between each of the rows on the spreadsheet. If, for example, the logger was set to take a reading every minute, and you set the time interval per row to 60, each row will be the min/max/average of 60 readings.

7.3.4 Event options

This dialog box appears when you click on when the **Events** window is active.

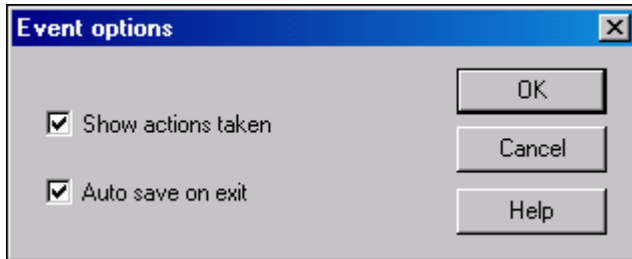
**Show actions taken**

When this is enabled, the details of actions taken will be displayed on the event window. This does, of course, reduce the number of events that can be displayed at the same time.

Auto save on exit

When this option is checked, all event window settings are saved automatically when you close the event window.

7.3.5 Event information dialog box

This dialog box appears when you double click on an event in the **Event** window. It enables you to enter notes against an event - for example, to state what actions were taken to deal with the problem.

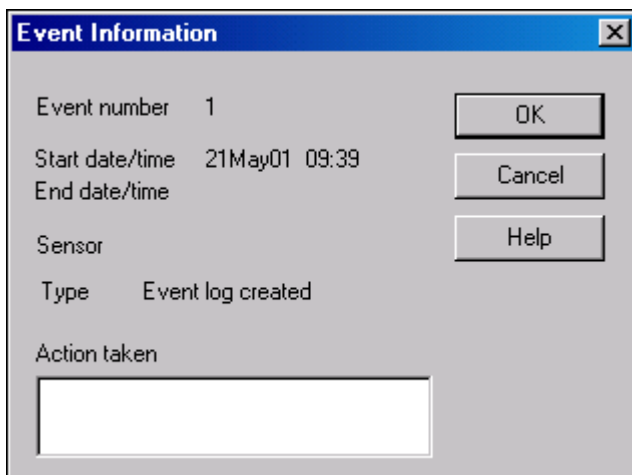

8 How to...

8.1 Configure a system

Setting up a small EnviroMon system is very easy. For more information, or if you have not yet decided upon the configuration, please see the section on [Identifying the equipment](#).

Even if you do not want to use a computer for day to day operation, you will need to connect a computer in order to configure the system.

Before you run the program, here is a checklist of things that you need to do, so that you have all of the information necessary to get the system going. You can use the Print button on the File menu above to get a paper copy of these instructions.

1. Draw a plan showing the locations where you wish to place sensors
2. Mark on it the locations where you want to place converters (each temperature converter can connect to three sensors)
3. Read the address written in the top right of each converter, and write one of these converter addresses on each converter on the plan

Note: Each converter must have a different address. If you have more than one converter with the same address, you must use the 'Change converter address' program to change the address of one of the converters, BEFORE attempting to configure the system.

Write down a table with the following details for each sensor:

- Location name
- Minimum and maximum value
- Holdoff time (if any) to allow for defrost cycles
- Converter address of the converter that you wish to connect it to
- Channel number on the converter (1 to 3) that you will use

Choose a sampling interval, as follows:

1. Divide the maximum number of readings (15,000) by the number of sensors that you wish to use. 10 sensors will give you a maximum of 1500 samples.
2. Work out the maximum time between computer downloads. For example, over a week-end would be three days- $3 \times 24 \times 60 = 4320$ samples
3. Divide the number of samples for the longest time interval (4320) by the maximum number of samples (1500) giving approx 3 minutes.
4. Sampling at five minutes would allow a margin for error (bank holidays, forgetting to download the data, etc).

Now you have all of the information available, you are ready to start.

1. If possible, connect together the logger, the converters and sensors next to the computer.
2. Start the EnviroMon software application
The computer will display the **Configuration control panel**
3. Click the **Expert** button
The configuration expert will guide you through the steps required to set up the system.

8.2 Use multiple loggers

If the loggers are to be connected directly to the computer, or are to be connected via a radio modem link, it is possible to access all of the loggers at the same time, so they can all be part of the same configuration. Just check the **Use multiple loggers** box, and you can then enter the details for a list of loggers.

For loggers on a telephone link, it is not possible to call all of the loggers at the same time, so it is necessary to create a separate configuration for each logger. Each configuration should have a different data path.

After configuring the first logger, rename the configuration file `envimon.ini` as (say) `leeds.ini`. You will find the `envimon.ini` file in the Pico directory. Next, create a configuration for the next logger and rename the new `envimon.ini` as (say) `brighton.ini`. It is then possible to access the two separate configurations by entering either

```
emw leeds.ini
```

or

```
emw brighton.ini
```

8.3 Use a dial-up modem

The EnviroMon logger is designed for easy access via a dial-up modem. The logger connects to one modem using an EL033 modem adapter. The computer connects directly to the other modem. The computer can then call the logger each time the EnviroMon program is run.

When you use a dial-up modem, it is necessary to set the link parameters for the logger so that it will do the following things:

- Operate at the maximum data rate supported by the modem (see below)
- Enable/disable the modem at times when it should accept calls.

Most modems have an internal buffer, and so it is possible to transfer data from the logger to the modem at full speed (57,600 baud) even if the modem can only send data at lower speed (for example, 14,400 baud) over the telephone link. If you set the logger to operate at 57,600 baud and it does not seem to work, try reducing the data rate to 9,600 baud.

It is also necessary to tell the PC what number to dial to establish a connection to the logger, and to specify whether to keep the link to the logger active until all data is transferred, or until the end of the EnviroMon session. If the link is kept active after the data is transferred, it is possible to monitor the current readings and to cancel alarms.

We recommend setting up the logger configuration using a direct connection, then changing to modem operation.

To change to modem operation, connect the logger to the modem port and then:

1. Go into the configuration menu (select **File** then **Configuraton**)
2. Select **Equipment**
3. Change the connection type to **via telephone modem**
4. Change the baud rate to 9600 baud (if required)
5. Select **Telephone**
6. Enter the telephone number
7. Specify whether the computer is to call the logger automatically
8. Specify any limits on the time that the logger may answer phone calls
9. Click the **Set Link** button on the logger dialog box
10. Disconnect power from the logger (and remove batteries if fitted)
11. Reconnect the power, and (if required) check that the logger says BAUD 9600

8.4 Measure parameters other than temperature

The EL016 and EL037 voltage converters can be used to accept inputs from a wide range of sensors. For sensors that the EnviroMon system does not know about, it is necessary to specify how the voltages from the sensor are to be converted to the parameter to be measured: this process is called [scaling](#).

8.5 Supply a user-defined scaling file

The EnviroMon system supports scaling only for the EL016, EL036 and EL037 converters. You can create a user scale file, `USER.PSC`, that will not be overwritten during software upgrades.

You can copy an entry from one of the standard `.PSC` files to `USER.PSC`, then make changes as required. Remember to change the 'Sensor number' to a value in the user range (1-99) so that it does not clash with the entry that you copied. You can edit `.PSC` files using the Windows Notepad program.

Pico software carries out scaling using a lookup table: a list of pairs of values, where each pair is made up of a raw value (in millivolts, unless the signal conditioner measures something different) and a scaled value in the appropriate parameter units.

For a sensor with a linear response, exactly two pairs (or points) are required; ideally, the top and bottom of the measured range. For a sensor with a non-linear response, more points will be required. Note that a large number of points may cause memory shortage problems in EnviroMon.

Below is an example of a scaling file which you can copy into your own `user.psc` and alter as desired. There explanations of each entry below.

For each scale that you require, there is a section like this:

```
[Scale1]
Name=Honeywell 26PC 0-5psi
Conditioner=15
Sensor=121
Units=psi
OutOfRange=2
Places=3
Method=0
NoOfPoints=2
Raw1=0
Scaled1=0
```

Raw2=100
Scaled2=5

Name=Honeywell 26PC 0-1psi

This is the name of the scaling method. The same scaling method could be used for multiple sensors (in this case, for example, the pressure from a number of different sensors of this type).

Conditioner=15

This specifies the type of conditioner that the sensor will work with. If this sensor does not require a signal conditioner, set the conditioner type to zero.

For the the 0-2.5V channel on the EL037 V/A converter, you need to set `Conditioner=371`, the 0-10V channel 372 and the 4-20mA channel 373.

Sensor=121

This is a unique reference for this scaling method. If you add your own sensors, please use sensor numbers in the range 1 to 99.

Units=psi

The units appear next to the parameter value on graphs, reports etc

Places=3

This is the number of decimal places. The options are 0, 1, 2 and 3. With `Places=1` the value 15 would be displayed as 15.0. With `Places=2`, the same number would appear as 15.00.

Method=0

This specifies the scaling method. At the moment, 0 (table lookup) is the only method.

Onoff=No

This parameter is currently used only for EnviroMon. For numeric parameters, `Onoff` should be `No`. For parameters that can have only two values (on or off), this should be set to `Yes`, and the scaling should be set so that for `Places = 1`, on = 100 and off = 0. The logger will then display On or Off for the parameter, and reports will show the percentage of time that the parameter was On.

OutOfRange= 0

This specifies what to do if the raw value is outside the range of the table lookup. The options are:

- 0 - treat as a sensor failure
- 1 - clip the value to the minimum or maximum table value
- 2 - extrapolate the value using the nearest two table entries.

NoOfPoints=2

This is the number of table lookup points.

Raw1=0**Raw2= 16.7**

These are the raw values for the first and second points. The raw value is normally in millivolts, but for the CM007 (4-20mA) conditioner, it is in mA.

Scaled1=0**Scaled2=1**

These are the scaled values for the first and second points (`Raw1` corresponds to `Scaled1`, etc). It is in the units specified by the `Units` parameter.

8.6 Transfer data to other applications

How to export historical data as text

You can export graphical data in each of the following three ways:

- By copying data from the spreadsheet window (to the clipboard)
- By writing data from the spreadsheet (to a disk file)
- By writing data directly to a comma separated value (CSV) disk file (using [Command line data export](#))

The first two methods are useful when you want to browse through the data in the spreadsheet window and then write small amounts of data to a text file.

The command line function is less intuitive, but has the following advantages:

- It gives you much more control over the range of data to be exported
- It works well even with large amounts of data
- You can set up a script to automate the export of data to a text file

How to export historical data as graphs

You can export text data by doing any one of the following:

- Copying the data from the graph window (to the clipboard)
- Writing data from the graph (to a disk file)
- Writing data directly to a BMP or JPEG disk file (using [Command line data export](#))

The first two methods are useful when you want to browse through the data in the graph window and then write one image to the clipboard or a text file.

The command line function is less intuitive, but has the following advantages:

- It gives you much more control over the range of data to be exported
- You can set up a script to automate the export of data to a JPEG file

Current data

There are two ways to transfer the current set of values to another application:

- Use [DDE \(Dynamic Data Exchange\)](#)
- Write the current readings to a file (see CurrentFile parameter in [Envimon.ini](#))

8.7 Display data on a web site

It is possible to display EnviroMon data on a web site. This could be used in several ways:

- To provide several within a company users with access to EnviroMon data
- To provide customers with access to EnviroMon data
- To enable remote access (for example, so that you can check a system from home when an alarm occurs)

EnviroMon can be used in two different ways:

- A very [safe method](#), where any computer can generate a fixed set of images and send them to a web server
- A more [interactive method](#), where the EnviroMon software runs on the web server and

dynamically creates images on request.

The EnviroMon system generates only JPEG images or CSV text files, not the complete HTML text required for web pages. This means that you can easily design web pages tailored to your requirements, incorporating the images or 'download' buttons to get the CSV files.

The safe method does not require a permanent internet connection: it could connect to the internet via a dial-up line, or could be placed safely behind a firewall on a company network. It is also relatively easy to set up: you only need to customise the simple example files to provide the images that you require. The EnviroMon software can run on any Windows computer, and can send data to any web server (including an ISP's server).

The interactive version must have the EnviroMon software running on an Windows 32-bit machine that is directly connected to the Internet. You will need to be capable of writing HTML and CGI scripts to provide fully interactive operation.

8.8 Safe method

The files that were used to generate the dynamic web pages on the pico web site (<http://www.picotech.com/dynamic/>) are available as samples. They are:

- `dynamic.html` - the html wrapper for the images
- `jpegs.bat` - a batch file to periodically generate images and send them to the web server
- `jpegs.ftp` - an ftp command file to send jpegs and CSV files to the web site.

You will need to customise these files to suit your own application.

- Modify the sample file `jpegs.bat` to produce the set of files that you require (see [Command line data export](#)). Here is a typical example:

```
emw32 -d
emw32 -jtoday.jpg -rtoday,start+1day -gtemperatures
emw32 -jthisweek.jpg -rmonday,start+1week, -gmains
```

- Modify the sample HTML files to contain your company details, and references to the jpegs that you want to display, and place the HTML files on your web server. Note: if you wish to restrict access to these web pages, you will need to add some sort of password access
- Create a user account on your web server, and authorise the user to FTP data into the directory for the image files. If possible, you should ensure that this user account cannot modify any other directories on your server
- Modify the ftp control file `jpeg.ftp` with the name of your server, and the username and password
- Manually run `jpegs.bat`
- Check that it generates the required files
- Check that the images were sent to the web server and are visible
- Add entries to the Windows task scheduler to run `jpeg.bat` at the required times

8.9 Interactive method

With the interactive method, the user can select any data, and the displayed data is always up to date. There are however, some important considerations.

- Security: especially if the server can be accessed from anywhere on the internet
- Setup cost: you will need to write HTML and CGI scripts to enable authorised users to select the required data, and have a computer running permanently

If you only require access from within a company network, this poses fewer security problems.

If you need to access the data from anywhere on the internet, you will need a server that is permanently connected to the internet. Given that the enviroMon software must operate on a Windows computer, it is essential to position the sever behind a firewall.

The following steps are required.

1. Set up a Windows computer that can be accessed from the required network
2. Install a web server (An Apache server can be downloaded free of charge)
3. Write HTML text for the web pages
4. Write CGI scripts that call emw32 to access the data.

You will need to arrange the download of data from the logger. This can be done in one of three ways:

- Have the EnviroMon software running continuously on the web server
- Run the software periodically using the task scheduler to do an offline download
- Do a download prior to every image file required

For the second and third options, the following command is required:

```
emw32 -d
```

Each individual data request will require a call like this to generate a jpeg file:

```
emw32 -jfred.jpg -r01May02@00:00,08May02@23:59
```

8.10 Command line data export

This feature can be used to generate a JPEG image or a comma separated value (CSV) data file from stored EnviroMon data. This can be used for several purposes:

- To create image and data files on an ad hoc basis
- To automatically generate frequently-used files at regular intervals
- To display data 'live' web site

To download data from a logger and then generate two data files, the following commands are required:

```
emw32 -d
emw -jmyfile.jpg -r20May02,27May02
emw -cmyfile.csv -r20May02,27May02
```

The first line downloads data from the logger: the subsequent lines each generate a specified JPEG file. Here is a full list of data export options:

-d	download data (cannot be used in conjunction with other options)
-j	generate a jpeg file
-c	generate a CSV file
-r	specify the time range
-g	specify a data group

The `d` option does not require any further information. It must not be used at the same time as any of the file generation options.

The `j` option is followed by a filename and up to three numbers. The numbers are

- width in pixels (default 640)
- height in pixels (default 480)
- image quality (default 75) - a higher number creates a better image, but a bigger file

The `c` option is followed by a filename.

If a filename contain spaces, the entire option must be surrounded by quotes, for example

```
-j"c:DocumentsPicture.jpg,400,300"
```

The `r` option is made up of a start datetime and an end datetime, separated by a comma. Important: the range must not contain any blanks. The range can be specified as fixed dates (for example 20may02) or as relative dates (today). The latter is useful when you wish to automate the process of creating a standard set of JPEG images that reflect the current position.

A datetime must contain a date, and can also contain a time and an offset. If no time is specified, the time is assumed to be 00:00 (midnight). The following combinations are therefore valid:

- date
- date-offset
- date+offset
- date@time
- date@time+offset
- date@time-offset

A date can be specified as one of the following:

- `15Dec01` - Day, Month name and year
- `today` - the current date
- `monday` - the Monday preceding today (other weekdays are valid)
- `first` - the first day of the current month.

A date and time can be specified as

- `now` - date and time now
- `date` - assumes the time is 00:00
- `date@15:00` - assumes 3pm on the specified date
- `start` - the start date/time [valid only in end]
- `end` - the end date/time [valid only in start]

An offset can be specified as a sign, a number and a keyword, for example +2days or -1hour. The following keywords are valid.

minute or minutes

hour or hours

day or days

week or weeks

month or months

year or years

The `g` option specifies what group of parameters to display. The groups can be defined using the **Channels** option on the graph or spreadsheet windows. If the group is blank, all channels are displayed. If the group is **monitor**, the program generates an image or CSV file for the monitor window.

9 Drivers

9.1 Windows drivers

There are two versions of the Windows DLL (Dynamic Link Library) for EnviroMon.

- EMW.DLL, is for use in 16-bit applications, for example Visual Basic 3, Excel 5, Borland C 4.52, Visual C 1.5, Delphi 1
- EMW32.DLL is for use in 32-bit applications, for example Visual Basic 4, 5 etc, Excel 7, Borland C 5, C++ Builder 3 and 4, Visual C 2,3,4,5,6 and Delphi 2, 3, 4

Please note that the drivers cannot be used at the same time as EnviroMon. If it is necessary to access the current readings while EMW is running, you should consider using Dynamic Data Exchange (DDE).

9.2 API

The API (Application Programmers' Interface) contains the following routines:

- [em_open](#) - open the driver
- [em_get_sensors](#) - get the number of sensors
- [em_get_current](#) - get current readings
- [em_close](#) - close the driver
- [em_open_reading](#) - open historical readings
- [em_get_reading](#) - get historical reading

The procedure for using the driver for current readings is as follows:

```
call em_open
```

while you want to get readings,

```
call em_get_current
```

process the current values

```
end while  
call em_close
```

9.2.1 em_open

```
void em_open (char * ini_filename)
```

This routine opens the specified ini file (normally ENVIMON.INI) and sets up a link to each of the loggers listed in the file. The ini file should have been created and tested using EnviroMon.

9.2.2 em_close

```
void em_close (void)
```

This routine closes down and links to loggers and shuts down the driver.

9.2.3 `em_get_sensors`

```
short em_get_sensors (void)
```

This routine returns number of sensors.

9.2.4 `em_get_current`

```
void em_get_current (short * current)
```

This routine fills the array 'current' with the current reading for each sensor. The return value is the number of sensors. The returned values are integers. If the sensor value has two decimal places, a reading of 24.51 will be returned as 2451. If no data is available, the value will be set to -32767.

9.2.5 `em_open_reading`

```
long open_reading(long no_required)
```

Use `em_open_reading` to 'open' historical readings. The return value is the amount of readings available.

9.2.6 `em_get_reading`

```
(READING * readings, long reading_no)
```

Routine fills structure readings with reading for each sensor and a status byte.

`READING` is defined as

```
typedef struct  
short temperature;  
unsigned char status;  
READING;
```

9.3 C

For Borland and Watcom C, Visual C version 1.5 or lower, use the `implib` program supplied with your compiler to produce an import library `emwxx.lib` from `emwxx.dll`, where `xx` = 16 or 32 as appropriate. The command is

```
Implib emwxx.lib emw.dll
```

For Microsoft Visual C versions 2, 4 and 5, Microsoft no longer supply `implib`. Furthermore, the names used in these versions of C are 'decorated'- there is a prefix which indicates how many bytes are transferred to the routine as parameters. As a result, the C names do not match the names in the DLL. The Microsoft tools to 'alias' decorated to undecorated names do not appear to work, so it is therefore necessary to use ordinal linking- linking by number, rather than name. To find the ordinal numbers for the DLL that you are using, type in `DUMPBIN /exports emw32.dll`

The ordinal numbers and decorated names are entered into `emw32.def`, then the following command generates a lib file: `Lib /def:emw32.def`

Once you have created a lib file, the following steps are then required to use the drivers in your program:

1. Include the `emwxx.lib` in your project
2. Include the file `emwdll.h` in the C source file(s) of your program.

See `emwdltes.c` for an example of a simple Windows program.

9.4 C++

C++ programs can access all versions of the driver. If `emwdll.h` is included in a C++ program, the `PREF1` macro expands to `extern "C"`: this disables "name-decoration", as Microsoft call it, and enables C++ routines to make calls to the driver routines using C headers.

9.5 Delphi

`emwp.dpr` is a complete program which opens the driver and takes current readings from channels 1 and 2. The file `emwdll.inc` contains a set of procedure prototypes that you can include into your programs.

9.6 LabVIEW

The routines described here were tested using LabVIEW for Windows 95 version 4.0.

It is possible to access all of the driver routines described earlier. The example supplied (`emw.vi`) shows how the routines can be called (Opens the unit, takes readings, closes the unit)

To use the example, copy `emw.vi` and `emw32.dll` to your LabVIEW `user.lib` directory.

10 Troubleshooting and maintenance

10.1 Troubleshooting

Logger won't communicate with the computer

This could be caused by:

- Incorrect port selected on computer
- Cable not connected or faulty
- Incorrect baud rate setting on logger

If you have an EL018 battery backup unit, but have failed to check the appropriate box in the Logger options dialog, the unit will assume that the mains power has failed. Plug the mains power adapter directly into the logger then reconfigure the logger.

Logger won't talk to one or more converters

This could be caused by:

- Incorrect logger configuration
- Faulty or disconnected cabling
- Faulty converter
- Faulty logger

See [Converter light](#) for information on interpreting the flashing light on the converter.

If none of the converters are working, disconnect all of them and connect one converter directly to the logger. If this fails, the logger is probably faulty. If it succeeds, try disconnecting sections of the network until it starts working.

If more than one converter is not working, and all of the malfunctioning converters are all on the same section of the network, replace the converter nearest the logger. If this cures the problem, the converter is faulty, otherwise the network cable leading to the nearest converter is probably faulty.

If just one converter is not working, do the following tests:

- Disconnect the network from the logger and connect the malfunctioning converter directly to the logger
- Connect another converter at the same location as the malfunctioning converter

Sensor fail or incorrect reading

This could be caused by:

- Sensor cable damaged or disconnected
- Sensor connector dirty
- Interaction with faulty sensor on same converter
- Faulty converter

If all of the sensors on one converter are misbehaving, replace the converter with another unit. If this cures the problem, the converter is faulty. If not, disconnect all of the sensors and plug in one sensor at a time.

Note: With this fault it may take some time for the logger to return to displaying the correct temperature. You can accelerate the process by restarting the logger after connecting each sensor.

If all sensors except one seem to function on their own, re-connect all of the sensors except the one that malfunctions.

10.2 Maintenance

Logger

The logger requires little maintenance. You should check at least once a year that the rechargeable battery is capable of operating the unit for a satisfactory period.

Converter

For a standard converter, disconnect the unit and inspect the connectors for signs of corrosion and for deposits of dust or debris.

If condensation is a problem, it is usually caused by damp air drawn into the box during cooling, and dry air being expelled as the box warms up. This can be eliminated by fitting a PVC breather pipe about a metre long to one of the cable glands.

Remote alarm

Check connectors for signs of corrosion, dust or debris. re-connect the unit and simulate a fault to check the audible alarm is working.

Alarm dialler

The Menvier dialler loses its telephone numbers and messages if the power goes off. If this happens, the unit will beep every few seconds, and will display a message. If the dialler is not in an occupied area, you should check it daily.

If operation during a mains power failure is required, you should check the battery every three months. First, run the PC software to download all data stored in the logger, then turn off the power to the alarm dialler. The left-hand green light should go off, but the right-hand green light should stay on. The logger should carry on operating as normal. Turn on the mains power again: the left hand green light should come on.

Once a year, you should check that the complete dialler system is working. First, notify all of the contacts that you are about to test the system, and check that they remember how to acknowledge the alarm. Next, simulate a fault by disconnecting a sensor. When the logger alarm starts sounding, one of the red lights on the dialler adapter should come on, and the dialler should start making calls.

Sensors

Check annually for signs of corrosion on the sensor, or for a build-up of debris on the connector.

10.3 Calibration

There are several levels of calibration:

- Calibration by a nationally accredited test house (eg NAMAS in the UK)
- Calibration using equipment calibrated against National Standards
- Comparison against other equipment as a 'sanity check'

Calibration by a nationally accredited test house is necessary only if there is some legal, regulatory or technical reason for doing so. For example, a company that manufactures gas meters might be required to prove that the meters were calibrated at a particular temperature.

Calibration using equipment calibrated against national standards is the most common option. This can be carried out by a test house, the manufacturer or distributor, or by the user if the required equipment is available.

The 'sanity check' test should be carried out by the user at intervals determined by the application, the hostility of the environment and the importance of accurate readings.

Unless the tests are carried out by Pico, the converter and sensor should be tested together.

Temperature sensor

EnviroMon temperature sensors are supplied sealed in stainless steel tubes, and are largely unaffected by their environment.

If the temperature is cycled repeatedly while the sensor is immersed or in a damp environment, small amounts of water may be drawn into the sensor: this may cause a rapid increase in the measured temperature.

If low or medium temperature sensors are exposed to high temperatures (greater than 120°C), the temperature reading may be permanently affected.

Calibration or checking using ice and/or boiling water is not recommended unless the user has a lot of experience with the required procedures. EnviroMon sensors can be compared with a calibrated reference sensor in any of the following ways:

- Insert both sensors in a bath of liquid which is being stirred continuously
- Insert both sensors into a large block of metal which is insulated from its surroundings
- Bind the two sensors together (with Sellotape or elastic bands) then wrap both sensors and some of the cable in several layers of bubble wrap.

Humidity sensor

Humidity sensors contain a sensor element that absorbs both water and other chemicals. The sensor element may quickly become inaccurate if it is exposed to chemicals.

Humidity is very strongly affected by temperature: a 1°C change difference in temperature between two sensors will produce a 2.5% difference in humidity reading.

It is therefore important to take the following precautions when calibrating:

- Use a sealed container that is as small as possible
- Keep the air inside the container moving, but mount the fan motor outside the box
- Insulate the container from conducted and from radiated heat sources.

Humidity sensors can be checked by

- Comparing with a calibrated reference sensor
- Measuring the humidity above a saturated solution of a salt (salt cell)

The two most commonly used salts are lithium chloride (11.3%) and sodium chloride (75.3%). These two are preferred because the relative humidity for these two salts is virtually constant over a wide temperature range, however you should note that lithium chloride undergoes a state change below 18°C, and calibration should be done above this temperature. Please study the safety information (available from a chemical supplier) before considering using lithium chloride.

Logger

Loggers do not require re-calibration.

Converter

Converters contain no adjustable parts. They are designed for high reliability, and contain built-in components to allow for changes over time, variations due to temperature etc.

11 File formats and other useful information

11.1 Program files

The following program files make up EnviroMon:

```
emw.exe      - main program file
emw???.dll  - language-specific information: ???=044 for English
emw???.hlp  - help file: ???=044 for English
```

EnviroMon makes no changes to any files in the Windows directory or the registry, nor does it require any installed drivers.

11.2 Envimon.ini

The majority of configuration information is held in a file called `envimon.ini`. If multiple configurations are required, this can be done by putting each configuration in a separate file, then specifying on the command line which file to use. For example, to use the `oxford.ini` file, the command line is

```
emw oxford.ini
```

Note: for multiple configurations, the data path must be different for each configuration.

The detailed information below is intended for information only. Where possible, we recommend using the EnviroMon program to make changes to the settings.

`Envimon.ini` contains the following sections:

```
[Loggerx]          - Details of a logger, x = logger number
[Loggerx, Converter y] - Details of a converter, x = logger y = converter
[General]          - General information
[Holdoff]          - Details of current holdoffs
[Events]           - Details of active events
[Graph1]           - Details of current graph
[Spread1]          - Details for current spreadsheet
[EventView1]       - Details of the event window
[Temperature]      - Temperature display information
[Alarm]            - Alarm options
[Site]             - Site information
[Preferences]      - Colours etc
```

```
[General]
```

```
NoOfLoggers=1
```

The number of loggers in this configuration

```
NoOfSensors=10
```

The number of sensors in this configuration

```
Configured=Yes
```

Set to Yes once the system is configured: until then, the EnviroMon program goes straight to the configuration menu.

`DataPath=d:\par`

This specifies where data is to be stored

`BackupPath=a:\par`

This specifies where a backup copy of data is to be stored

`AutoBackup=Yes`

This specifies whether the program should automatically create a new backup file each time you exit the program

`Session=0`

This specifies how the EnviroMon program operates the link to the logger. It is important when operating a telephone link, as it is usually desirable to remain connected for as short a period as possible.

- 0 - connect at start-up and remain connected
- 1 - connect at start-up and disconnect once data is transferred
- 2 - do not connect at start-up

`DeleteAfter=0`

This specifies how long data files are to be retained for. The options are:

- 0 - indefinitely
- 1 - one month
- 2 - three months
- 3 - one year

`MinutesPerReading=10`

The time interval, in minutes, between readings

`SampleMode=0`

Indicates how to take readings

- 0 - when the logger memory is full, wrap
- 1 - when the logger memory is full, stop
- 2 - stop when max-readings samples have been recorded

`MaxReadings=1000`

The number of readings to take when SampleMode is zero.

`CurrentFile=`

If you specify a filename here, EnviroMon will write the current readings to a text file with this name, every sample interval. This can be used to transfer the data to another application. For example:

`CurrentFile=Current.txt`

`Footer=`

If you wish to replace the footer on reports with text of your own, you can add this parameter, specifying an alternative footer. For example:

`Footer=Joe's frozen foods`

`RefreshDelay=0`

Sets the time delay, in seconds, between monitor updates. A value of 60 would mean that the monitor display would be update only once per minute.

[Holdoff]

[Events]

Do not change these two sections

[Loggerx]

There is one Loggerx section for each logger: x is the logger number.

Connection=0

This specifies how the logger is connected to the computer.

0 - direct

1 - via telephone modem

2 - via radio modem

BaudRate=9600

If present, this over-rides the speed of the link to the logger.

Port=1

For direct connections ,this specifies which serial port the logger is connected to.

Telephone=01584-823263

This is the telephone number to dial when the connection type is 1 (telephone modem)

Address=1

This is the logger address. It is 1 for direct and telephone loggers, but must be a different number for each logger connected by radio modem.

Printer=0

This specifies the type of printer connected to the logger. The options are:

0 - no printer

1 - Epson FX100

2 - Datac tally-roll

PrintCurrent=No

This specifies whether the current values are to be printed at specified intervals

PrintSummary=No

This specifies whether a summary report (min/max/average) is to be printed at specified interval

CurrentMinutes=60

This is the time interval, in minutes, between print-outs of the current values.

SummaryMinutes=1440

This is the time interval, in minutes, between print-outs of the summary report.

MainsFailMinutes=5

NetFailMinutes=5

NoOfConverters=7

`AnswerStart=1260`

`AnswerEnd=1320`

These specify the time range (in decimal minutes- 1260 means 21:00) during which the logger will enable a modem to answer telephone calls.

`diallerPresent=No`

This indicates whether the EL018 dialler/battery backup module is connected. If so, the logger is unable to detect mains failure, as it is not connected directly to the mains adapter.

`[Logger1, Converter1]`

There is one entry like this for every converter in the system. It contains the information that appears in the converter list.

`Address=5`

The converter address

`Type=4`

The converter type

`[Sensor1]`

`Name=Box`

The sensor name is displayed by the logger and appears on reports

`Logger=1`

The logger that this sensor is connected to

`Converter=12`

The address of the converter that this sensor is connected to

`Channel=1`

The channel on the converter for this sensor

`Active=Yes`

This is Yes while the sensor remains in use, and is set to No when the sensor is no longer required.

`ConverterType=2`

This is the type of converter

`Type=0`

This is the type of sensor- see the scaling dialog for more details (0 = default)

`AlarmEnabled=No`

This is Yes if the alarm is enabled for this sensor

`Minimum=-2000`

This is the minimum threshold for alarms

`Maximum=7000`

This is the maximum threshold for alarms

`Holdoff=0`

This is the holdoff period in minutes for the alarm

[Graph1]

[Spread1]

[EventView1]

These sections contain information about the current windows. If a particular window is causing problems, it may be worth while erasing the corresponding section of the INI file.

[Alarm]

Hysteresis=50

This controls the amount of hysteresis used for alarms. See the Alarm dialog box for a detailed description.

Latch=No

This specifies whether the alarm should continue to sound until the user cancels the alarm, even if the alarm condition goes away in the meantime.

[Site]

Name=Fresher Foods Limited

Maintenance=I C Gale Refrigeration Ltd 01116-212405

This information appears on graphs and spreadsheets.

[Preferences]

Colour7=8421376

Colour8=8388863

Colour9=12632256

This specifies the colours of traces for the graph.

FirstDayOfWeek=0

This parameter specifies which day is to be treated as the first of the week. This is used by the 'Select this week' button in the Graph window. The default value of 0 means Monday, 1 means Tuesday, etc.

11.3 .RDG files

Each time the computer connects to the logger, it transfers any new readings from the logger and saves them in a reading (.RDG) file. The filename is a hex date code (see below) containing the date and time of the most recent addition to the file.

The computer adds the data to the most recent file UNLESS one of the following conditions applies:

- Data file would exceed 64k bytes
- Settings have changed since the last data was transferred
- Values span a month end.

The last rule is so that, if required, it is possible to dispose of data files after a certain period of time (say three months).

When new data is received, the current data file is replaced by a new file which contains both the existing data and the new data. When the current data file is full, or at the start of a new month, the program creates a new file that contains the following components:

- A reading header record
- A list of the sensor numbers stored in this file
- The reading data

Reading header record

```
typedef struct
UNS16 version;
UNS16 no_of_readings;
UNS16 no_of_sensors;
UNS32 gmt_start;
UNS32 gmt_end;
UNS16 minutes_per_reading;
UNS8 spare [40];
READING_HEADER;
```

Sensor numbers

This is a list of the sensor numbers for which data is recorded. There is a 16-bit value for each sensor. If, for example, the file contains data for sensors 1, 3 and 4 (sensor 2 is disabled), `reading_header.no_of_sensors` would be set to 3, and the sensor number list would contain 1, 3 and 4. There would be three sensor reading entries for each reading.

Reading data

```
typedef struct
INT16 temperature;
UNS8 status;
SENSOR_READING;
```

Each reading is made up of a block of 3-byte `SENSOR_READING` records, one for each entry in the sensor number table.

Date/time code

The date/time code is made up of the time, in minutes, and the day number. Day 1 is the 1st January 1980.

Date/time code = day number * 1440 + time

11.4 EMWEVENT.LOG

This file contains details of the events that have occurred since the log was created (parameters out of range, equipment failures, etc).

11.5 DDE

Dynamic Data Exchange (DDE) is a convenient method of transferring the current set of readings to other applications. Data is transferred approximately once per second.

Data items are identified by three keywords: Application, Topic and Item. The keywords accepted by EnviroMon are:

```
Application    EMW
Topic          Current
Item           Name - parameter name
```

Value - the current value

Units - the units

Alarm - the alarm status

Each DDE request returns a list of values for each parameter.

To read the current values into Excel, type the following command into a spreadsheet cell:

```
=EMW|Current!Value
```

To read the current values into Quattro Pro, type in the following command into a cell:

```
@DDELINK([EMW|Current]Value)
```

Most application programming languages (C, Delphi, Visual Basic) provide tools to make DDE requests from other applications.

12 Communications protocols

12.1 EnviroMon logger protocol

The computer normally uses 57,600 baud for a direct link to a logger, and 9,600 over a modem link. Data is transmitted with 8 data bits, two stop bits, no parity. No flow control lines are used.

All messages to and from the logger have the following format:

Byte	Name	Usage
1	length	This is the total length of the message, including 3-byte header and 1-byte checksum. The maximum message length is 254 bytes.
2	address	This is normally 1, unless you are using several loggers on a multi-logger radio modem network
3	function	0: LF_GET_BLOCK 19: LF_GET_READING_VALUES Other functions are available.
4	DB1	This is the data part of the message.
...	...	
4+n-1	DBn	
4+n	checksum	Calculate the SUM of all preceding bytes. Checksum is (0xDE - SUM)

The computer sends a request to the logger, and then the logger sends a response (for most functions, within 200 ms).

LF_GET_BLOCK

When the computer wants to get a block of data from the logger, it sends an LF_GET_BLOCK request, which contains two bytes of data in the data part of the message:

Byte	Name	Usage
DB 1	Block ID	0: LB_VERSION 3: LB_CURRENT 4: LB_NO_OF_READINGS 10: LB_FIRST_READING 11: LB_MAX_READINGS 14: LB_ALARM_ACTIVE
DB2	Section number	You probably won't need this. We can supply more information if required.

The data part of an LF_GET_READING response for an LB_CURRENT request is as follows:

Byte	Name	Usage
DB1	value 1 MSB	most significant (upper) byte of current reading for sensor 1
DB2	value 1 LSB	least significant (lower) byte of current reading for sensor 1
DB3, 4	value 2	current reading for sensor 2
DB5, 6	value 3	current reading for sensor 3
...	

The data part of an LF_GET_BLOCK response for an LB_ALARM_ACTIVE request is as follows:

Byte	Name	Usage
DB1	alarm 1	Alarm status for sensor 1 0 - alarm off 1 - alarm on
DB2	alarm 2	Alarm status for sensor 2
DB3	alarm 3	Alarm status for sensor 3
...	

LF_GET_READING_VALUES

Before attempting to get stored readings from the logger, it is necessary to read the following three blocks:

```
LB_NO_OF_READINGS
LB_FIRST_READING
LB_MAX_READINGS
```

The readings are stored in a circular buffer that contains 15,000 two-byte values. Values below -32511 are reserved for error codes, leaving numbers between -32511 and 32767 for data values.

Example

If a logger is configured for three sensors, and is left running for an hour collecting one reading every 5 minutes, these values will be as follows:

```
LB_NO_OF_READINGS = 12 (12 x 5 minutes = 1 hour)
LB_FIRST_READING  = 0
LB_MAX_READINGS   = 5000 (calculated by software)
```

If the logger is left until 6000 readings have been collected, the values will be:

```
LB_NO_OF_READINGS = 5000 (not 6000, because LB_NO_OF_READINGS cannot
                          exceed LB_MAX_READINGS)
LB_FIRST_READING  = 1000 (location of oldest reading in buffer)
LB_MAX_READINGS   = 5000
```

After 6000 readings have been taken, the buffer will contain the following values:

Value number	Reading number	Channel number
0	4000	0
1	4000	1
2	4000	2
3	4001	0
...		
2996	4998	2
2997	4999	0
2998	4999	1
2999	4999	2
3000	0	0
3001	0	1
3002	0	2
3003	1	0
3004	1	1
..		
14995	3998	1
14996	3998	2
14997	3999	0
14998	3999	1
14999	3999	2

The reading buffer is accessed by sending a LF_GET_READING_VALUES message asking for a sequence of values. To improve the data transfer rate, you can ask for up to 125 values to be returned at once.

The data part of the LF_GET_READING_VALUES message contains the following data:

Byte	Name	Usage
DB1	value no MSB	most significant (upper) byte of value no
DB2	value no	
DB3	value no	
DB4	value no LSB	least significant (lower) byte of value no
DB5	no of values	number of values to send

To get the values for 3 channels for the oldest five readings in the above example,

$$\begin{aligned} \text{value no} &= 1000 \times 3 = 3000 \\ \text{no of values} &= 5 \times 3 = 15 \end{aligned}$$

The response would contain the following data:

Byte	Name	Usage
DB1	value 3000 MSB	value for reading 1 channel 1
DB2	value 3000 LSB	
DB3,4	value 3001	value for reading 1 channel 2
DB5,6	value 3002	value for reading 1 channel 3
DB7,8	value 3003	value for reading 2 channel 1
DB9,10	value 3004	value for reading 2 channel 1
...		
DB29,30	value 3014	value for reading 5 channel 3

13 Messages

13.1 Computer messages

Logger not found

This message indicates that the computer could not make contact with the logger. See [Troubleshooting](#).

Logger configuration appears to be incorrect

This message indicates that the logger configuration is not the same as the configuration in the computer. If you have more than one logger, check that you have connected the correct logger, and that you are using the correct settings in the computer. You can prevent this message from recurring by re-writing the logger configuration. (click Program in the Configuration control panel).

Operation failed

If the dialog box also says `Get Logger Version`, this message indicates that the computer could not make contact with the logger. See [Troubleshooting](#).

If the dialog box also says `Halt the Logger`, you will probably find that the operation will succeed if you try again straight away.

If the dialog box says `Write Text`, contact Pico for a computer software upgrade. Alternatively, shorten all of your sensor names 15 characters or less.

13.2 Converter light

When a converter is first connected to the network, or the logger is first powered up, the light on the converter starts flashing approximately four times per second.

When the converter receives a message of any kind from the logger, the light stops flashing.

Once the logger is configured and starts asking for readings from the converters, the light will flash three times (EL001) or twice (EL026) every four or five seconds.

Index

A

- Adding converters 54
- Adding users 49
- Alarm 46
 - behaviour 46
 - dialler 11, 13
- Alarms 11, 13
 - EL006 20, 26
 - EL016 53
 - remote 14
- API 78
- Auto configure converter 53

B

- Battery backup 11, 16, 20
 - EL018 10, 11, 16, 20, 26, 53

C

- C programs 79
- C++ programs 80
- CO017 18
- Cables 14, 28
 - EL003 14, 28
 - sensor cables 17
 - spur cable 14
 - WI001 14
- Calibrating humidity converters 32
- Calibration 32, 82
- CO017 16
- CO018 14, 16
- Cold junction compensation 26
- Communications protocols 92
 - EnviroMon logger 92
- Connecting up the equipment 31
- Connection on alarm 56
- Connection to logger 56
- Connectors 16
 - CO018 14, 16
 - FCC68 16
- Continuous operation 11
- Converters 6, 13, 21
 - Current Monitor Converter 10
 - EL001 5, 9, 14, 22, 23
 - EL016 5, 10, 22

- EL026 5, 10, 18, 23, 32
- EL037 5, 10, 23
- EL040 5, 10, 25, 28
- EL041 9, 26
 - for thermocouples 9
- Current clamps 10, 28
 - TA011 10, 28
 - TA011 19
- Current measurement 10, 19
- Current Monitor Converter 25
- Current Monitoring Kit 10, 28
- Current transformer 25

D

- D25 to D9 adaptor 31
- D9-to-D25 adapter 29
- Data file cleanup 48
- Data storage and analysis 11
 - printing 11
 - reports 11
 - spreadsheets 11
- DDE 78, 91
- Delphi programs 80
- Diagnostics 57
- dialler 11
- dialler adapter 20
- diallers 13
 - EL018 10, 11, 16, 20, 26, 53
- Dialog boxes 54
 - Add converter 54
 - Colours 63
 - Converter list 53
 - Event Information 68
 - Event options 68
 - Graph options 66
 - Language 63
 - Logger 51
 - Logger dialup options 56
 - Logger list 58
 - Logger Options 55
 - Network diagnostics 57
 - Password 51
 - Print 66
 - Select parameters 65
 - Sensor alarm 61
 - Sensor information 60
 - Sensor list 59
 - Sounds 64
 - Spreadsheet options 67
 - User information 50

Dialog boxes 54
 User list 49
 Voltages 58
 Digital signals 13
 Displaying a graph 35
 DLLs 78
 Drivers 78
 Dynamic Data Exchange 91

E

Editing user details 50
 EL001 5, 14, 22, 23
 EL003 14, 28
 EL005 10, 11, 20, 21, 28
 EL006 20, 26
 EL008 14, 21, 29
 EL009 14, 16
 EL015 18
 EL016 5, 10, 22, 53
 EL018 10, 11, 16, 20, 26, 53
 EL020 18
 EL021 16
 EL026 5, 10, 18, 23, 32
 EL030 10, 18, 32
 EL032 18
 EL037 5, 10, 23
 EL040 5, 10, 25, 28
 EL041 26
 em_close 78
 em_get_current 79
 em_get_reading 79
 em_get_sensors 79
 em_open 78
 em_open_reading 79
 Equipment 6
 Equipment button 51
 Equipment placement 13
 Extension cable 18
 C0017 18
 EL032 18
 WI001 18

F

FCC68 16

G

General configuration info panel 43
 GSM telephone 6

H

Holiday dates 47
 How to... 69
 configure a system 69
 display data on a web site 73
 export data via the command line 75
 measure parameters other than temperature 71
 transfer data to other applications 73
 use a dialup modem 70
 use multiple loggers 70
 use the interactive method 75
 use the safe method 74
 Humidity measurement 10
 Hysteresis 46

I

Identifying the equipment 29
 In the event of power failure 11
 Installation 29, 31

J

Junction boxes 16
 EL021 16

L

LabVIEW programs 80
 Legal information 8
 Logger 10, 11, 21, 28
 EL005 10, 11, 21, 28
 EL005 without display 20
 EL008 11, 14, 21, 29
 internal parameters 21
 options 55
 voltage settings 58
 Logger configuration 13
 Looking at current readings 34

M

Mains voltage 5, 21
 Maintenance 82
 Measurements 10, 19
 current 10, 19
 humidity 10

Measurements 10, 19
 other parameters 10
 temperature 9, 18, 19
 temperature and humidity 18
Measuring other parameters 10
Messages 95
 converter light 95
 on the computer 95
 pager 56
 SMS 56
Mode 44
Multiple loggers 58

N

Network 13
 fixed 14
 junction unit 16
Network current 21

O

Options 68
 events 68
 spreadsheet 67

P

Printer adapter 55
Printing 11
Program files 90
 .RDG files 90
 EMWEVENT.LOG 91
 Envimon.ini 85
 naming conventions 85
Programs 79
 in C 79
 in C++ 80
 in Delphi 80
 in LabVIEW 80

R

Radio link 6
Radio modem 12
Remote alarm 26
Remote data collection 12
Repairs 5
Reports 11
Routine download 56

RTTE directive 12

S

Safety grounding 5
Safety warning 5
Sampling interval 44
Scaling 71
Screw terminal connections 16
SE000 19
SE001 19
Security 13
Sensor adapters 18
 EL020 18
Sensor connections 17
Sensor connector 18
Sensors 13
 CO017 16
 EL015 9, 18
 EL030 32
 EL030 18
 exposed wire fibreglass thermocouple 19
 exposed wire PTFE thermocouples 19
 for measuring humidity 10
 gas 10
 low power 10
 platinum resistance 9
 precision thermistors 9
 SE000 19
 SE001 19
 temperature 18, 19
 temperature and humidity 18
 thermistors 9
 thermocouples 9
 Type K 9
Sensors EL030 10
Serial port 29
Setting alarms 11
Setting converter addresses 32
Settings 55
 alarm 55
 voltage 58
Setup 43
 alarm 43
 colours 63
 event information 68
 holiday 46
 holiday dates 47
 languages 63
 logger 51
 password 51

- Setup 43
 - site 43
 - site information 47
 - sounds 64
 - specifying data storage details 48
 - summer time 43
 - summer time dates 48
- Site information 47
- Sockets 16
 - wall mount 16
- Software 7
 - configuration 7
 - installation 31
- Solar panel 12
- Specifying data storage details 48
- Speech dialler 26
- Starting the EnviroMon software application 7
- Storing site details 47
- System 7, 33, 69
 - configuration 7, 33, 69
 - low power 10
 - maintenance 9
 - testing 13

T

- TA011 10, 19, 28
- Taking other measurements 10
- Telephone button 56
- Telephone modem 12
- Temperature and humidity measurement 18
- Temperature converter 22
- Temperature display 45
- Temperature measurement 9, 18, 19
- Temperature monitoring 11
- Temperature sensor 29
- Temperature/humidity converter 23
- Terminal blocks 16
- Testing 13
 - an EnviroMon system 13
 - system 13
- Thermocouple converter 26
- Thermocouples 19
 - exposed wire fibreglass 19
 - exposed wire PTFE 19
 - SE000 19
 - SE001 19
- Troubleshooting 81

U

- USER.PSC 71

V

- Voltage converter 22, 23

W

- Wall sockets 14, 16
 - EL009 14, 16
- WI001 14, 18
- Window 41
 - events 41
 - graph 37
 - monitor 36
 - spreadsheet 40
 - summary 39
- Windows drivers 78

Interworld Electronics & Computers Inc.

P.O. Box 1280
145 Tye Drive, Suite 3120
Point Roberts, WA 98281

Tel: 1-877-902-2979
Fax: 1-877-FAX-IECI
Web: www.interworldna.com