

- 3/4-16 Stud Input w/Nut
- BNC (Amphenol) Output

6X ϕ .41 [10] THRU
ON A 5.25 [133] BOLT CIRCLE

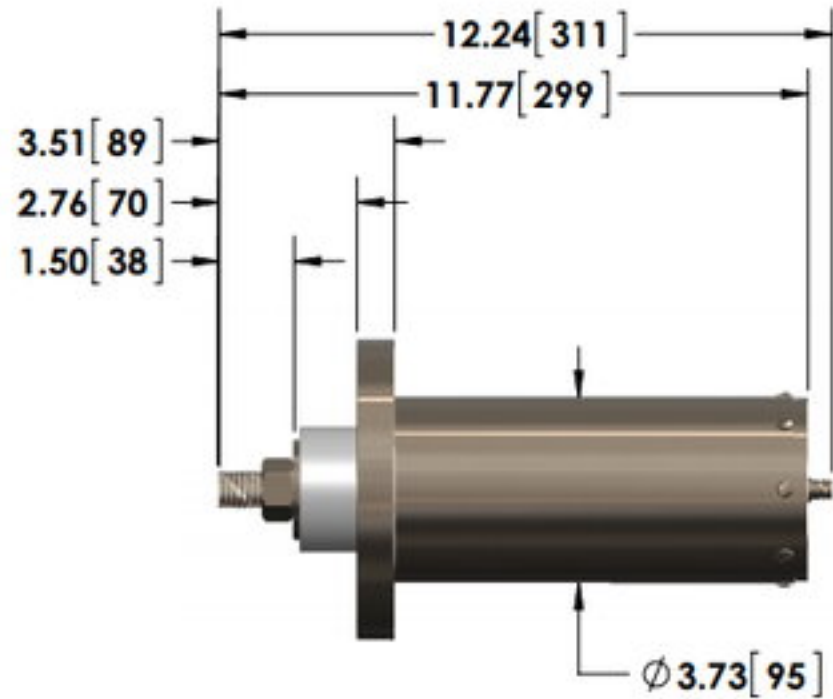

Specifications subject to change without notice.

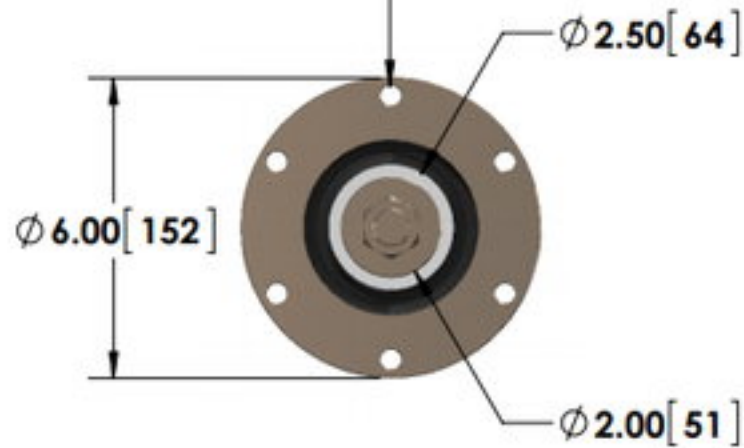

T & M RESEARCH PRODUCTS, INC.

TITLE:

R SERIES - 225 Watt Units

DIMENSIONS:

inch[mm]

DATE:

04-02-2015