

MICROGRID® III

Series of Digitizers

User's Manual

Summagraphics Corporation
Sixty Silvermine Road
Seymour, CT 06483-3907
U.S.A.

Telephone: 203-881-5400
800-729-7866

Fax: 203-881-5367

LIMITED WARRANTY ON MEDIA, MANUALS AND SOFTWARE

If you discover physical defects in the software media or in the manuals distributed with the software, Summagraphics Corporation will replace the media or manuals at no charge to you, provided you return the item to be replaced with proof of purchase, including purchase date, to Summagraphics or to an authorized Summagraphics dealer during the one year period after you purchased the software. In some countries the replacement period may be different; check with your authorized Summagraphics dealer.

Software, in the context of this warranty, can be in any form, including firmware.

Even though Summagraphics has tested the software, SUMMAGRAPHICS MAKES NO WARRANTY OR REPRESENTATION, EITHER EXPRESS OR IMPLIED, WITH RESPECT TO THIS SOFTWARE, ITS QUALITY, PERFORMANCE, MERCHANTABILITY, OR FITNESS FOR A PARTICULAR PURPOSE. AS A RESULT, THIS SOFTWARE IS SOLD "AS IS", AND YOU, THE PURCHASER, ARE ASSUMING THE ENTIRE RISK AS TO ITS QUALITY AND PERFORMANCE.

THE WARRANTY AND REMEDIES SET FORTH ABOVE ARE EXCLUSIVE AND IN LIEU OF ALL OTHERS, ORAL OR WRITTEN, EXPRESS OR IMPLIED, IN FACT OR IN LAW. No Summagraphics dealer, agent, or employee is authorized to make any modification, extension or addition to this warranty.

Summagraphics reserves the right to make changes to the software or its documentation without notice. IN NO EVENT WILL SUMMAGRAPHICS BE LIABLE FOR DIRECT, INDIRECT, SPECIAL, INCIDENTAL, OR CONSEQUENTIAL DAMAGES RESULTING FROM ANY DEFECT IN THE SOFTWARE OR ITS DOCUMENTATION (including but not limited to typographical, arithmetic or listing errors), even if advised of the possibility of such damages. In particular, Summagraphics shall have no liability for any programs or data stored in or used with Summagraphics's products, including the costs of recovering such programs or data.

Some states do not allow the exclusion or limitation of implied warranties or liability for incidental or consequential damages, so the above limitation or exclusion may not apply to you. This warranty gives you specific legal rights, and you may also have other rights which vary from state to state.

LIMITED WARRANTY ON HARDWARE

Summagraphics warrants to the original purchaser that this equipment, including its components and parts, shall be free from defects in material and workmanship for a period of one year from the date of shipment. Summagraphics's obligation under this warranty shall be limited to repair or replacement, at the option of Summagraphics, Seymour, Connecticut. Return of a repaired instrument shall be F.O.B. Summagraphics, Seymour, Connecticut. The above warranty is contingent upon normal usage and does not cover products which have been modified without Summagraphics's approval or which have been subjected to unusual physical or electrical stress or on which the original identification marks have been removed or altered. The above warranty will not apply if adjustment, repair, or parts replacement is required because of accident, neglect, misuse, failure of electric power or air-conditioning, humidity control, transportation, or causes other than normal and ordinary usage. To the extent that any of its equipment is furnished by a manufacturer other than Summagraphics, the foregoing warranty shall be applicable only to the extent of the warranty furnished by such other manufacturer. This warranty will not apply to appearance terms, such as knobs, handles, dials, or the like, nor to the pen cartridge or refills of the pen cartridge.

THERE ARE NO WARRANTIES WHICH EXTEND BEYOND THE DESCRIPTION ON THE FACE HEREOF. The foregoing obligations are in lieu of all obligations and liabilities, including all warranties, implied or statutory, and state Summagraphics's entire and exclusive liability and Purchaser's exclusive remedy for any claim of damages in connection with the sale or furnishing of all equipment, including design, suitability for use, operation or installation. In no event shall Summagraphics be liable for any special or consequential damages.

About This Manual

The Microgrid III User's Manual provides all of the information you need to install and use your Microgrid III tablet. For your convenience, we have organized the manual into three parts: Microgrid III User Information, Microgrid III Programming Reference, and Appendices.

First Time Users

Part I: Microgrid III User Information

This part is designed for first time users. If you are unfamiliar with digitizing, and this is your first Summagraphics tablet, we recommend that you read this part first. It covers all of the basics you'll need to know to get your tablet up and running as quickly as possible - - preparing for installation, installing and configuring the tablet, digitizing with the tablet, and using the drivers/utilities software.

Advanced Users

Part II: Microgrid III Programming Reference

This part is designed as a technical reference for advanced users and software developers. It covers the following information: Microgrid III commands, Microgrid III output formats, and guidelines for writing software drivers.

Part III: Appendices

This part provides additional technical information about the Microgrid III. The following appendices are provided:

- Microgrid III Interfacing Hardware
- Microgrid III DIP Switch Settings
- Specifications (Physical, Performance, and Environmental)
- GTCO Format Emulation
- Calcomp Format Emulation
- MM/SummaSketch Format Emulation
- ASCII Conversion Chart
- Microgrid III Applications Set Up

Table of Contents

PART I: MICROGRID III USER INFORMATION

	Chapter 1 Pre-Installation Considerations.....	3
1.1	Pre-Installation Considerations.....	4
1.1.1	Equipment Moving Considerations.....	4
1.1.2	Checklist of Equipment.....	4
1.1.3	Guidelines for Unpacking Equipment.....	5
1.1.4	Overview of Installation Procedures.....	5
	Chapter 2 Installing Your Microgrid III.....	7
2.1	Pre-Installation Overview.....	8
2.1.1	Equipment Overview.....	8
2.1.2	Controller Overview.....	9
2.2	Installing the Microgrid III.....	10
2.2	Installation Procedures.....	10
	Chapter 3 Digitizing With The Microgrid III	
3.1	Operational Overview.....	16
3.1.1	How the Microgrid III Works.....	16
3.1.1.1	Active Area.....	16
3.1.1.2	Margin Area.....	16
3.1.1.3	Proximity.....	16
3.1.1.4	Resolution.....	17
3.2	Using the Stylus and Cursors.....	18
3.2.1	Overview.....	18
3.2.2	Microgrid III Stylus Options.....	18
3.2.3	Microgrid III Cursor Options.....	18
3.2.3.1	The 16-Button Cursor.....	18
3.2.4	Using Multiple Pointing Devices.....	19
3.2.5	General Tips.....	19
	Chapter 4 Summagraphics LT Drivers and Utilities.....	21
4.1	Introduction.....	22
4.1.1	Overview.....	22
4.1.2	The Drivers/Utilities Diskette.....	22
4.1.3	DOS Prompt vs. Batch Files.....	22
4.1.4	TSR Applications.....	22
4.2	Summagraphics Driver For Autodesk Applications.....	23
4.2.1	Introduction.....	23
4.2.2	Using DGMG.COM.....	24
4.2.3	Examples.....	24
4.2.4	Configuring AutoCAD For Use With DGMG.COM.....	24
4.2.5	Using DGPMG.EXP.....	25
4.2.6	Configuring AutoCAD For Use With DGPMG.EXP.....	26
4.3	Summagraphics Tablet Driver/Mouse Emulator.....	27
4.3.1	Introduction.....	27
4.3.2	Running TABLETMG.COM From The DOS Prompt.....	27
4.3.3	Examples.....	29
4.3.4	Running TABLETMG.COM From CONFIG.SYS.....	30

Table of Contents

	Chapter 4 Summagraphics LT Drivers and Utilities (cont.)	
4.4	Summagraphics Driver For Microsoft Windows	31
4.4.1	Introduction.....	31
4.4.2	Installing The Windows Driver	31
4.4.3	Modifying Driver Defaults With The Control Panel	33
4.5	Testing The Tablet: The MG3TEST Utility	37
4.5.1	Introduction.....	37
4.5.2	Running MG3TEST.....	37
4.5.3	The MG3TEST Main Menu.....	37
4.5.3.1	Display Coordinates Option	38
4.5.3.2	Diagnostic Tests Option.....	39
4.6	Resetting The Tablet: The UIOFRST Utility.....	41
4.6.1	Introduction.....	41
4.6.2	Running UIOFRST.....	41
4.6.3	Examples.....	41
4.7	Changing Tablet Parameters: The SEND.COM Utility	42
4.7.1	Introduction	42
4.7.2	Running SEND.COM.....	42
4.7.3	Examples.....	43
	Chapter 5 Maintenance and Troubleshooting.....	45
5.1	Routine Maintenance	46
5.1.1	Cleaning the Microgrid III.....	46
5.1.2	Cursor Care.....	46
5.1.3	Stylus Care.....	46
5.2	Diagnostics and Troubleshooting.....	47
5.2.1	Power-Up Diagnostics.....	47
5.2.2	Troubleshooting.....	47

PART II: MICROGRID III PROGRAMMING REFERENCE

	Chapter 1 Microgrid III Commands.....	51
1.1	Reset Command	52
1.2	Change Emulation Command	53
1.3	Communication Protocol Commands.....	54
1.4	Data Format Commands.....	56
1.5	Report Mode: Overview.....	58
1.6	Report Mode: Prompt	59
1.7	Report Mode: Point.....	60
1.8	Report Mode: Stream and Switch Stream	61
1.9	Report Mode: Set Report Rate	62
1.10	Report Mode: Increment	63
1.11	Proximity Transmission Command	64
1.12	Transmission Control: Stop and Start	65
1.13	Select Transducer Command	66
1.14	See-Thru Command.....	67
1.15	Sound Annunciator Commands	68
1.16	LED Control Commands	69

Table of Contents

Chapter 1 Microgrid III Commands (cont.)	
1.17	Relocate Origin Command.....70
1.18	Resolution Commands: Fixed Resolution.....71
1.19	Resolution Commands: Variable Resolution.....72
1.20	Resolution Commands: Confirm Resolution.....73
1.21	Skew Correction Command.....74
Chapter 2 Microgrid III Output Formats and Commands.....75	
2.1	UIOF Output Format.....76
2.1.1	Overview.....76
2.1.2	ASCII BCD Report Format.....76
2.1.3	Packed Binary Report Format.....78
2.1.4	UIOF Command Summary.....80
Chapter 3 Guidelines For Writing a Software Driver.....81	
3.1	Flowcharts For Writing Drivers.....82
3.1.1	General Flowchart For Master Program to Read and Process Digitizer Reports.....82
3.1.2	Detail A: Get Binary Format Report.....83
3.1.3	Detail B: Get Binary Format Report, Poll/Remote Mode or Stream Mode.....84
3.1.4	Detail C: Get Byte From Tablet.....85
3.1.5	Detail D: Normalize Bytes Into X and Y Coordinates, Switch and Proximity Information.....86
PART III: APPENDICES	
Appendix A Microgrid III Interfacing Hardware.....89	
A.1	Microgrid III Interfacing Hardware.....90
A.1.1	RS-232-C Hardware Interface.....90
A.1.2	RS-232-C Port Pin Assignments.....90
A.1.3	Cable Diagrams.....91
Appendix B Microgrid III DIP Switch Settings.....93	
B.1	Microgrid III DIP Switch Table.....94
B.2	Microgrid III vs Microgrid II Switch Settings.....97
Appendix C Microgrid III Specifications.....101	
Appendix D GTCO Format Emulation.....105	
D.1	GTCO Output Format.....106
D.1.1	Overview.....106
D.1.2	ASCII BCD Report Format.....106
D.1.3	Packed Binary Report Format.....108
D.1.4	GTCO DIP Switch Settings.....110
Appendix E Calcomp Format Emulation.....111	
E.1	Calcomp Output Format.....112
E.1.1	Overview.....112
E.1.2	ASCII BCD Report Format.....112
E.1.3	Packed Binary Report Format.....114
E.1.4	Calcomp DIP Switch Settings.....116

Table of Contents

	Appendix F MM Format	117
F.1	MM/SummaSketch Format Emulation.....	118
F.1.1	Overview.....	118
F.1.2	Binary Report Format.....	118
F.1.3	ASCII BCD Report Format.....	120
F.1.4	MM/SummaSketch Command Summary.....	121
F.1.5	MM/SummaSketch Switch Settings.....	122
	Appendix G ASCII Conversion Chart	123
	Appendix H Microgrid III Application Set Up	127

Microgrid III User Information

Part I explains how to get up and running with your Microgrid III tablet. It covers all of the basics you'll need to know - - preparing for installation, installing and configuring your tablet, digitizing, and using the drivers/utilities software.

First Time Users

If you are a first time user, we recommend that you read Part I first before you attempt to install and use your tablet. Take time to familiarize yourself with the Microgrid III and how it works.

Advanced Users

If you are an advanced user, and your tablet is already installed, go to "Part II: Microgrid III Programming Reference". This part of the manual provides technical information on the Microgrid III commands, the Microgrid III output formats, and on writing software drivers.

You'll find the following chapters in part I:

Chapter 1	Pre-Installation Considerations
Chapter 2	Installing The Microgrid III
Chapter 3	Digitizing With The Microgrid III
Chapter 4	Summagraphics LT Drivers And Utilities
Chapter 5	Maintenance And Troubleshooting

Chapter 1

Pre-Installation Considerations

Chapter one covers pre-installation tasks that should be completed before installing your Microgrid III system. It includes Equipment Moving Considerations, Equipment Checklist, Guidelines for Unpacking Equipment, and an Overview of Installation Procedures.

1.1	Pre-Installation Considerations.	4
1.1.1	Equipment Moving Considerations.	4
1.1.2	Checklist of Equipment.	4
1.1.3	Guidelines for Unpacking Equipment.	5
1.1.4	Overview of Installation Procedures.	5

1.1 Pre-Installation Considerations

1.1.1 Equipment Moving Considerations

Plan your moving route carefully so that the equipment cartons will fit through doorways and stairwells. Below is a listing of the overall tablet size, active area size, carton dimensions, and carton weights for each Microgrid III tablet.

<u>Overall Tablet Size</u>	<u>Active Area Size</u>	<u>Carton Dimensions</u>	<u>Carton Weight</u>
26" x 32.5"	17" x 24"	41" x 30" x 4"	26 lbs.
32.5" x 26"	24" x 17"	41" x 30" x 4"	26 lbs.
29" x 29"	20" x 20"	37" x 33" x 4"	25.5 lbs.
32.5" x 44.5"	24" x 36"	53" x 37" x 4"	43 lbs.
44.5" x 56"	36" x 48"	65" x 50" x 4"	68 lbs.
51.35" x 68.38"	44" x 60"	75" x 54" x 4"	125 lbs.

1.1.2 Checklist of Equipment

Below is a checklist of the equipment required for a complete Microgrid III system.

Required Equipment

- Microgrid tablet and controller assembly
- Power supply (100 volt, 115 volt, 220 volt, or 240 volt)
- PC cable
- Stylus/Cursor (2- or 3-button stylus, 4- or 16-button cursor)

Recommended Optional Equipment

- Manual or power-lift digitizer stand (recommended for tablets 24 x 36 and larger)
- Microgrid III Tilt Stand (recommended for tablets 20 x 20 and smaller)
- Stylus or cursor holders
- 9-pin-to-25-pin AT adapter cable
- Summagraphics LT Drivers/Utilities Software, 3 1/2" and 5 1/4" diskettes

1.1.3 Guidelines For Unpacking Equipment

Consider the following guidelines when unpacking and inspecting your Microgrid equipment.

- Check the cartons you have received against those listed on the invoice. Report any discrepancies to the carrier and/or place of purchase.
- Inspect the outside of the cartons for signs of damage that may have occurred during shipping. Report any shipping damages to the carrier immediately.
- Note any positional markings on the carton when removing the equipment. Two people may be required to remove the heavier components from the cartons.
- Unpack and inspect each piece of equipment for damage and report any discrepancies to the place of purchase.

1.1.4 Overview of Installation Procedures

Below is an overview of the procedures required to get your Microgrid III tablet up and running.

1. Unpack Equipment Cartons page 5
2. Assemble Tablet Stands and Mount Tablet (refer to the installation instructions provided with your specific stand)
3. Connect PC Cable page 10
4. Connect Stylus/Cursor page 10
5. Connect Power Supply page 11
6. Check DIP Switch Settings page 12
7. Power Up Tablet page 13

Chapter 2

Installing Your Microgrid III

Chapter two provides basic instructions for getting your Microgrid III up and running in the default configuration. It assumes that you have already mounted your Microgrid III to the appropriate stand by following the instructions shipped with the stand. This chapter covers connecting cables, setting DIP switches, and powering up the tablet.

2.1	Pre-Installation Overview	8
2.1.1	Equipment Overview	8
2.1.2	Controller Overview	9
2.2	Installing the Tablet	10
2.2.1	Installation Procedures	10

2.1 Pre-Installation Overview

2.1.1 Equipment Overview

Below are the components that make up a complete Microgrid III system:

- Tablet and controller assembly
- 1 PC cable
- 1 power supply (100 volt, 115 volt, 220 volt, or 240 volt)
- Stylus and/or cursor(s) depending on your configuration. Cursor options include the Microgrid 16-button cursor, the four-button cursor with fine cross hair, and the standard four-button cursor. Stylus options include the two- or three-button stylus.
- Stand Mounting Hardware Kit

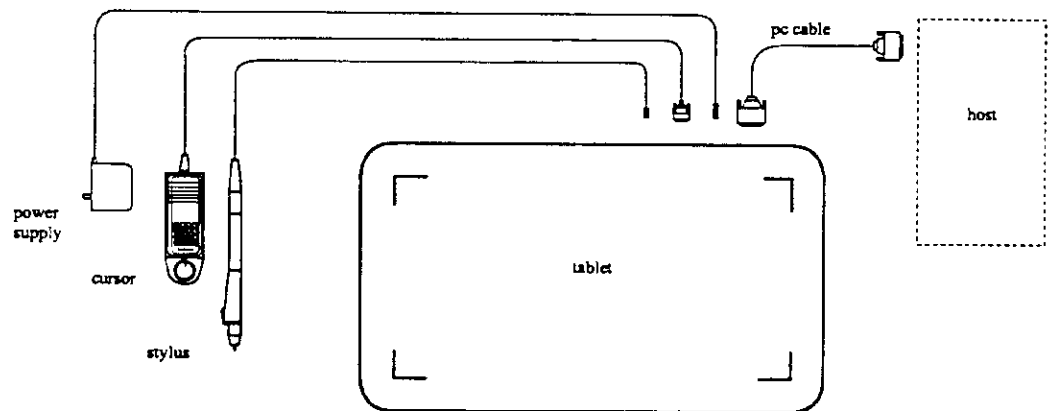

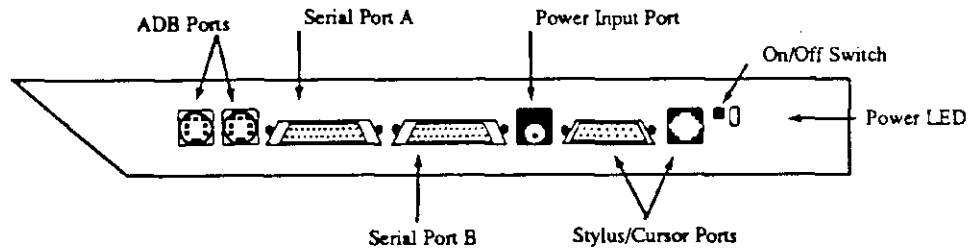

Each of the controller ports are described below.

ADB (Apple Desktop Bus) Ports - - The ADB ports interface the Microgrid III to a Macintosh ADB system. There are two ports; ADB devices may be daisy-chained. *If you wish to use the ADB interface, you must purchase the ADB interface kit from Summagraphics. Contact your Summagraphics dealer for further information.*

Serial Ports - - The serial ports interface the Microgrid III to an RS-232-C compatible computer. There are two ports: Serial Port A, which is configured as DTE (Data Terminal Equipment), and Serial Port B, which is configured as DCE (Data Communications Equipment).

Power Input Port - - Input port for the Microgrid III power supply (12 VAC; 1 AMP).

Stylus/Cursor Ports - - Used for the Microgrid III stylus/cursor options: 16-button cursor, four-button cursor with fine cross hair, standard four-button cursor, two-button stylus, and three-button stylus.

2.2 Installing the Tablet

2.2.1 Installation Procedures

1. Make sure the controller power switch is in the OFF position before connecting any cables.
2. If you are using our PC cable, plug the cable into Serial Port A on the controller. Plug the other end of the cable into the serial port on the back of your computer.

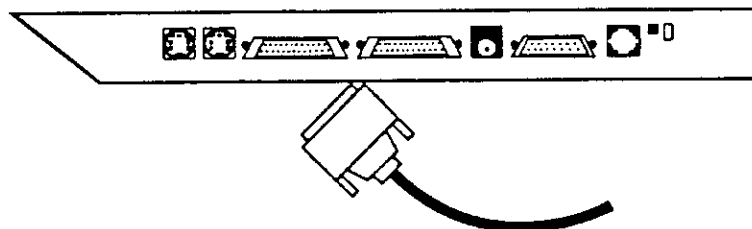

NOTE: If your computer has a 9-pin port, use the 9-pin-to-25-pin adapter cable between the PC cable and your computer. Contact your Summagraphics dealer for further information about adapter cables.

3. Connect the stylus and/or cursor to the appropriate port(s).

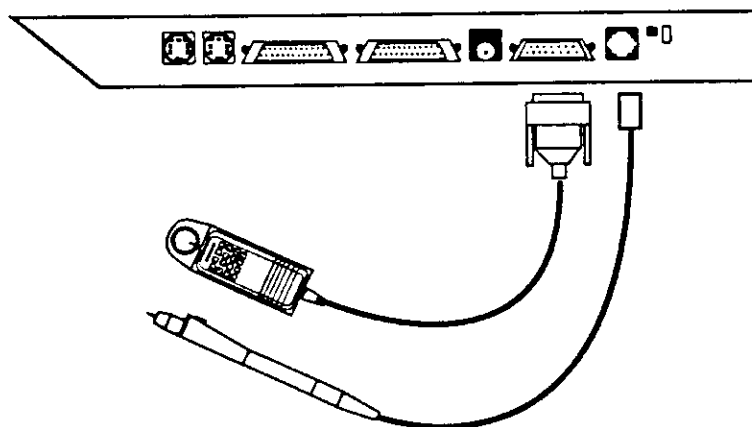

2.2 Installing the Tablet

4. Plug the power supply into the power input port on the Microgrid III controller.

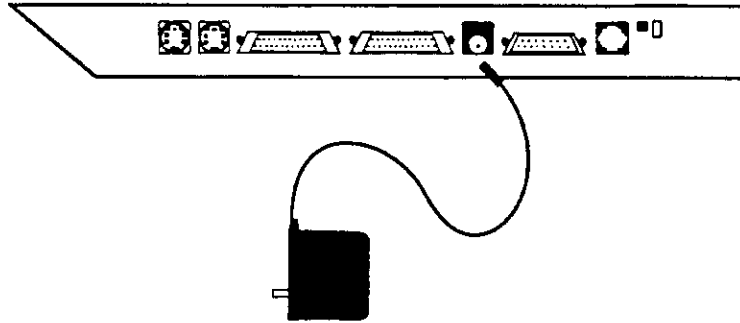

Next, plug the other end of the power supply into its rated electrical outlet (110 V, 220 V, etc.).

WARNING: Use only a Microgrid III power supply. A substitute could damage the tablet and would void the FCC and UL certifications, as well as the warranty.

5. Check the DIP switch settings. The DIP switches are located in the lower left-hand corner of the controller panel. There are three banks of eight switches, labelled 1, 2 and 3. Refer to the table of Microgrid III default DIP switch settings on the following page.

2.2 Installing the Tablet

The DIP switches are set in the following default configuration when you receive your tablet. (Refer to Appendix B for a complete table of Microgrid III DIP switch settings.)

Microgrid III Default DIP Switch Settings

SET 1	1-1	1-2	1-3	1-4	1-5	1-6	1-7	1-8
BAUD: 9600	ON	OFF	OFF	-	-	-	-	-
PARITY:								
ENABLED:	-	-	-	-	ON	-	-	-
EVEN:	-	-	-	ON	-	-	-	-
STOP BITS:2	-	-	-	-	-	ON	-	-
DATA BITS: 7	-	-	-	-	-	-	OFF	-
REPORT FORMAT: BINARY	-	-	-	-	-	-	-	OFF
SET 2	2-1	2-2	2-3	2-4	2-5	2-6	2-7	2-8
RESOLUTION: ENGLISH	-	-	-	OFF	-	-	-	-
FIXED RESOLUTION: 1000 LPI	-	-	-	-	OFF	ON	-	-
ASCII REPORT FORMAT:								
COUNTS:	ON	-	-	-	-	-	-	-
ASCII REPORT TERMINATOR:								
CR:	-	-	OFF	-	-	-	-	-
ASCII DECIMAL POINT:								
EXCLUDE	-	OFF	-	-	-	-	-	-
FORMAT EMULATION:								
UIOF	-	-	-	-	-	-	OFF	OFF
SET 3	3-1	3-2	3-3	3-4	3-5	3-6	3-7	3-8
REPORT COLLECTION MODE:								
STREAM:	ON	ON	-	-	-	-	-	-
ECHO: OFF	-	-	OFF	-	-	-	-	-
PROXIMITY TRANSMISSION:								
ONLY IN-PROX	-	-	-	OFF	-	-	-	-
MARGIN TRANSMISSION:								
ONLY IN ACTIVE AREA	-	-	-	-	OFF	-	-	-
DUAL TRANSDUCER:								
DISABLED:	-	-	-	-	-	OFF	-	-
TRANSDUCER SELECT:								
CURSOR:	-	-	-	-	-	-	ON	-
CUSTOMIZED OPTION	-	-	-	-	-	-	-	OFF

If you wish to change a DIP switch setting, depress the side of the switch you wish to activate using a small screwdriver. Do not use a lead pencil.

2.2 Installing the Tablet

6. Power up the tablet. To turn the tablet on, press the power button, located on the controller panel. The system emits three tones, telling you that the Microgrid III is functioning properly. The power light illuminates, letting you know that the tablet is on and receiving power.

If you hear only one or two tones when powering up your Microgrid III, or no tones at all, your tablet is not functioning properly. Refer to Part I, Chapter 5 for service information.

Your Microgrid III tablet is now up and running.

7. Finally, install the optional cursor holder. The cursor holder provides a convenient holding place for the cursor while you are not using it. You can easily mount and re-position the holder to accommodate any tablet position. Installing the cursor holder involves three steps:
 - 7a. Select a place on the tablet top where the holder will not interfere with your work (usually about an inch from the tablet edge).
 - 7b. Attach the mounting pad to the tablet. The mounting pad is a round disk, comprised of two half circles. Remove the protective backing from the two halves to expose the adhesive. With the flat sides together, press the two halves on the tablet. The tablet surface should be clean. Use the extra mounting pads in other locations on the tablet or as spares.
 - 7c. To attach the holder to the mounting pad, simply press it to the pad. A gentle rocking motion is effective. To remove the holder from the pad, peel it from a corner rather than pulling straight up.

To remove a mounting pad from the tablet, peel the pad from the tablet and clean off any adhesive residue with isopropyl alcohol.

Chapter 3

Digitizing With The Microgrid III

Chapter three provides an overview of the Microgrid III, including how the Microgrid III works, and how to use the stylus and cursors.

3.1	Operational Overview.....	16
3.1.1	How the Microgrid III Works	16
3.1.1.1	Active Area.....	16
3.1.1.2	Margin Area.....	16
3.1.1.3	Proximity.....	16
3.1.1.4	Resolution	17
3.2	Using the Stylus and Cursors.....	18
3.2.1	Overview	18
3.2.2	Microgrid III Stylus Options	18
3.2.3	Microgrid III Cursor Options.....	18
3.2.3.1	The 16-Button Cursor	18
3.2.4	Using Multiple Pointing Devices.....	19
3.2.5	General Tips.....	19

3.1 Operational Overview

3.1.1 How the Microgrid III Works

The Microgrid III is a digitizer. A digitizer is an input device that lets you translate graphic information, such as a drawing or photograph, into a computer readable format.

This is how the Microgrid works. The Microgrid has two main parts, the tablet and the pointing device. The pointing device may be either the stylus or cursor. A grid within the tablet emits a low-intensity signal. The stylus/cursor reads this signal when it is moved across the tablet.

Therefore, for the stylus/cursor to sense this signal, it must be over the grid, or **active area**, and close enough to the grid, or in **proximity**. (Active area and proximity are described below.)

The Microgrid expresses the stylus/cursor position as an X, Y coordinate pair, which is called a **report**. Valid reports can only be collected when the stylus/cursor is in the tablet's active area and in proximity. Reports are in absolute coordinates (measured from the tablet's origin) and are expressed in inches, millimeters, or counts of resolution (described below).

3.1.1.1 Active Area

The active area is the area on the tablet surface in which the stylus/cursor position can be identified. It is marked on the tablet by corner brackets.

3.1.1.2 Margin Area

The margin area is the region outside of the active area.

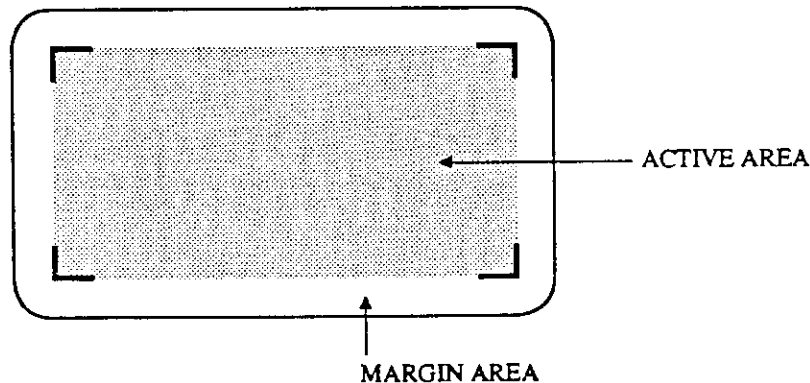

3.1.1.3 Proximity

Proximity is the maximum distance above the active area that the stylus/cursor can be held and report a position. The proximity limit for the Microgrid III is .50". Together, the active area and proximity establish a three-dimensional volume within which the stylus/cursor can issue reports. Reports issued from outside this volume are out of proximity (out-of-prox) and, therefore, do not represent the current position of the stylus/cursor.

3.1 Operational Overview

3.1.1.4 Resolution

Resolution is the "fineness" of detail that the tablet can distinguish. Resolution is expressed in lines per inch (lpi) or lines per millimeter (lpm).

Reports are measured in counts of resolution. One count is the distance between two lines of resolution. As shown below, each square is one count of resolution. The tablet reports the same coordinates for any point within the square.

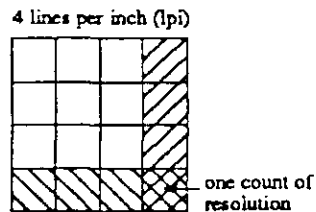

With different resolution settings, you can get different reports for the same tablet location. In the illustration below, points A and B are the same physical locations on the tablet, but their coordinates are different because of the resolution setting.

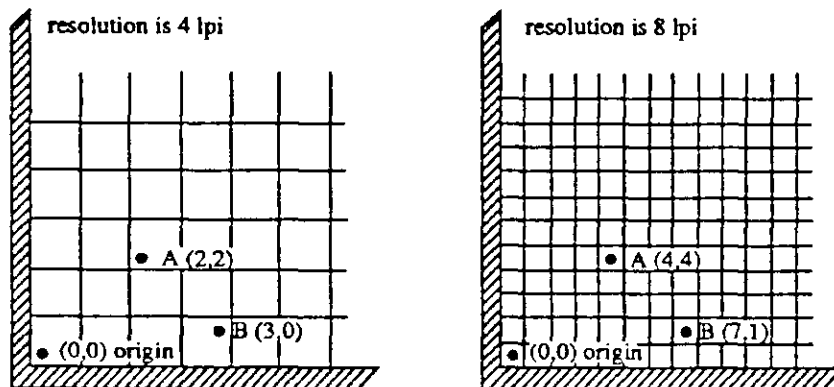

The Microgrid III tablet provides two different resolution functions: Fixed Resolution and Variable Resolution. See Part II, Chapter 1, for further information on these commands.

3.2 Using the Stylus and Cursors

3.2.1 Overview

The Microgrid supports several different stylus and cursor options, which are described below. The Microgrid controller has two stylus/cursor ports; one port for the 16-button cursor or the four-button cursor with fine cross hair, and one port for the stylus or the standard four-button cursor. This allows the tablet to support two pointing devices at all times, and provides many different user options, including the ability to use a stylus for freehand drawing while simultaneously using the 16 cursor buttons for application functions. (See section 3.2.4 of this chapter for further information on using multiple pointing devices.)

3.2.2 Microgrid III Stylus Options

A stylus is a pen-shaped instrument used to locate points on the tablet. Because it is similar in size and shape to a pen or pencil, it is natural to the hand and is recommended for freehand drawing. The Microgrid III supports both a two-button stylus and a three-button stylus, which plug into the stylus/cursor port on the Microgrid III controller.

3.2.3 Microgrid III Cursor Options

A cursor is a hand-held device, also used to locate points on the tablet. The cursor has a cross hair for precisely sighting points and is therefore recommended for tracing and menu picking. The Microgrid III supports three different cursor options:

- Sixteen-Button Cursor with LEDs
- Four-Button Cursor (with fine cross hair)
- Standard Four-Button Cursor

3.2.3.1 The 16-Button Cursor

The 16-Button cursor provides 16 buttons that may be programmed with application-specific functions. The cursor also has three LEDs, designed to provide user feedback.

Left Yellow LED - - Indicates which pointing device is selected. When this LED is lit, the 16-button cursor is the active pointing device. When the LED is off, the other pointing device is selected. When the LED is blinking, neither pointing device is active.

Center Green LED - - Indicates proximity for either pointing device.

Right Yellow LED - - You may program this LED with a specific application function.

See Part II, Chapter 1, for further information on programming the LEDs.

3.2 Using the Stylus and Cursors

3.2.4 Using Multiple Pointing Devices - - The 16-Button Stylus Feature and Dual Transducer Mode

The Microgrid III supports multiple pointing devices:

The 16-Button Stylus Feature - - This feature allows you to use a stylus as your main pointing device while using the 16 buttons of the cursor for specific application functions. The 16-button stylus feature is built into the Microgrid system, and is operational whenever a cursor and stylus are plugged into the controller at the same time. The cursor and stylus transmit to the host as follows:

- If you push only stylus buttons, then the stylus transmits information to the host.
- If you push only cursor buttons, then the cursor transmits information to the host.
- If you push both a stylus and a cursor button at the same time, then the cursor buttons override the stylus buttons.

The Dual Transducer Mode - - This mode allows you to use either the stylus or cursor as your pointing device when both are plugged into the controller at the same time. Unlike the 16-button stylus feature, where the 16-button cursor may only be used for application functions and not to generate reports, dual transducer mode allows both transducers to generate reports. When in dual transducer mode, the transducer that is in proximity is the one that is active. If both transducers are out of proximity, the tablet continually monitors the proximity status of both transducers. The first transducer to return to proximity will be "active" until it is taken out of prox again. For further information on dual transducer mode, refer to "Select Transducer Command" in Part II, Chapter 1 of this manual.

3.2.5 General Tips

- The cursor and stylus have the same functionality. You can use them to trace, draw, etc. The stylus is more natural to the hand, so it is better for freehand drawing. The cursor has the cross hair for precisely sighting points, so it is better for tracing and menu picking.
- The cursor is most accurate when held parallel with the tablet surface. To activate a cursor button, press it. When tracing, use the cross hair to precisely sight information.
- The two-button stylus has one barrel button and a refill tip. The three-button stylus has two barrel buttons and a refill tip. To activate a stylus button, press gently.

Chapter 4

Summagraphics LT Drivers and Utilities (optional)

Chapter four provides information on using the Summagraphics LT Drivers/Utilities. It covers the following drivers and utilities: Autodesk (ADI) Drivers, Summagraphics Tablet Driver/ Mouse Emulator, Microsoft Windows Driver, MG3TEST Tablet Test Utility, UIOFRST Tablet Reset Utility, and SEND.COM Tablet Configuration Utility.

4.1	Introduction	22
4.1.1	Overview	22
4.1.2	The Drivers/Utilities Diskette	22
4.1.3	DOS Prompt vs. Batch Files	22
4.1.4	TSR Applications	22
4.2	Summagraphics Driver For Autodesk Applications	23
4.2.1	Introduction	23
4.2.2	Using DGMG.COM.....	23
4.2.3	Examples.....	24
4.2.4	Configuring AutoCAD For Use With DGMG.....	24
4.2.5	Using DGPMG.EXP.....	25
4.2.6	Configuring AutoCAD For Use With DGPMG.EXP.....	26
4.3	Summagraphics Tablet Driver/Mouse Emulator	27
4.3.1	Introduction.....	27
4.3.2	Using TABLETMG.COM	27
4.3.3	Examples.....	29
4.3.4	Running TABLETMG.COM From CONFIG.SYS.....	30
4.4	Summagraphics Driver For Microsoft Windows	31
4.4.1	Introduction	31
4.4.2	Installing The Windows Driver	31
4.4.3	Modifying Driver Defaults With The Control Panel	33
4.5	Testing The Tablet: The MG3TEST Utility	37
4.5.1	Introduction	37
4.5.2	Running MG3TEST	37
4.5.3	The MG3TEST Main Menu	37
4.5.3.1	Display Coordinates Option	38
4.5.3.2	Diagnostic Tests Option	39
4.6	Resetting The Tablet: The UIOFRST Utility	41
4.6.1	Introduction	41
4.6.2	Running UIOFRST	41
4.6.3	Examples.....	41
4.7	Changing Tablet Parameters: The SEND.COM Utility	42
4.7.1	Introduction.....	42
4.7.2	Running SEND.COM.....	42
4.7.3	Examples.....	43

4.1 Introduction

4.1.1 Overview

This chapter is your guide to using the Summagraphics Drivers/Utilities software. It assumes that you have experience with basic DOS tasks such as changing directories, copying files, and creating batch files. If you are unfamiliar with any of these tasks, refer to a DOS user's manual before continuing.

As the industry standard for graphics tablets, Summagraphics tablets are supported by most application software. The drivers described in this chapter are for those few situations where the application fails to support Summagraphics tablets. If your application does support Summagraphics tablets, do not use the drivers described in this chapter. Doing so could send the application conflicting information.

4.1.2 The Drivers/Utilities Diskette

You'll find four subdirectories on the drivers/utilities diskette:

- ADIDVR - - contains the ADI drivers for Autodesk® applications (both protected mode and real mode versions).
- TABLTDVR - - contains the TABLETMG.COM tablet driver/mouse emulator.
- WINDVR - - contains the driver and control panel for Microsoft® Windows.
- UTILITY - - contains the MG3TEST.COM, SEND.COM, and UIOFRST.COM utilities.

Before installing any of the drivers or utilities, make a backup copy of the Drivers/Utilities diskette. Use only your copy and store the master in a safe place.

4.1.3 DOS Prompt vs. Batch Files

You may run the Drivers/Utilities by typing commands at the DOS prompt, or by creating batch files. We have included examples of running the drivers/utilities from the DOS prompt, as well as sample batch files, throughout the chapter. If you require additional information on batch files and how to create them, refer to your DOS user's manual.

4.1.4 TSR Applications

Most of the drivers in this manual are TSR (Terminate and Stay Resident) programs. Strange behavior in your software can be caused by the sequence in which you load or run TSR programs on the system. If this occurs, experiment with the loading sequence. If one sequence doesn't work, try another.

If the problem persists, it is probably in the application software. Contact the application manufacturer or your local dealer for assistance.

4.2 Summagraphics Driver For Autodesk Applications

4.2.1 Introduction

There are two UIOF/Microgrid format drivers for Autodesk applications. Use these drivers if you have configured AutoCAD for a real or protected mode ADI driver.

Note: ADI drivers are less likely to encounter initialization problems when "shelling out" of AutoCAD, therefore, Summagraphics recommends using the ADI drivers supplied on the Drivers/Utilities disk instead of AutoCAD's internal drivers.

Summagraphics provides both a real mode driver and a protected mode driver:

- **DGMG.COM** - - The real mode driver for ADI™ (Autodesk Device Interface) applications. This driver can be used on all DOS versions of AutoCAD.
- **DGPMG.EXP** - - The protected mode driver for ADI version 4.1 supported applications. Use this driver if you have a release 11 386 DOS extender version of AutoCAD and wish to take advantage of AutoCAD's protected mode capabilities.

DGMG.COM and DGPMG.COM require your tablet dip switches to be configured as follows:

	1	2	3	4	5	6	7	8
SET 1	ON	OFF	OFF	ON	ON	ON	OFF	OFF
SET 2	ON	OFF	OFF	OFF	OFF	ON	OFF	OFF
SET 3	ON	ON	OFF	OFF	OFF	OFF	ON	OFF

Check your Microgrid DIP switches to confirm the proper settings.

4.2.2 Using DGMG.COM

First, make sure that DGMG.COM is in the current directory. Then, at the DOS prompt type the following:

```
DGMG [Com port] [Transducer] [Mode]
```

where [com port], [transducer], and [mode] are replaced with the options listed below. If you type only DGMG, the tablet defaults to the options marked with an asterisk (*).

Com Port Option

```
/1    Com1 *  
/2    Com2  
/3    Com3, only on IBM PS/2 systems  
/4    Com4, only on IBM PS/2 systems
```

4.2 Summagraphics Driver For Autodesk Applications

4.2.2 Using DGMG.COM (cont.)

Transducer Option

/CP Selects two-button stylus *
/C4 Selects four-button cursor
/C16 Selects sixteen-button cursor

Mode Option

/AC Standard ADI mode *
/AS AutoSketch Digitizing mode (supports tablet digitizing mode for AutoSketch applications)

Note: Use of the /AS option makes DGMG.COM a non-ADI specification driver. Although the /AS option allows the screen and the tablet to have the same aspect ratio, approximately two inches on the right-hand side of the screen cannot be accessed when in this mode. As a result, certain dialog box buttons (Cancel and OK) cannot be accessed by the tablet. However, you may activate these commands by using the "ESCAPE" and "ENTER" keys on the keyboard.

Disabling The Driver

/OFF Disables driver

4.2.3 Examples

For a Microgrid tablet with a 16-button cursor connected to Com 1 in standard ADI mode, type the following at the DOS prompt:

```
DGMG /1 /C16
```

Sample Batch File

```
DGMG /1 /C16                    installs driver  
CD \SKETCHDR                   changes to application directory "SKETCHDR"  
SKETCH                         runs application "SKETCH"
```

4.2.4 Configuring AutoCAD For Use With DGMG

After you have installed the ADI driver, and restarted your computer, start up AutoCAD and follow the instructions listed below.

1. Select "Configure AutoCAD" from the screen menu. A listing of the current configuration appears on the screen. Press ENTER to proceed to the configuration menu.

4.2 Summagraphics Driver For Autodesk Applications

4.2.4 Configuring AutoCAD For Use With DGMG (cont.)

2. At the configuration menu, select "Configure Digitizer". AutoCAD asks if you want a new digitizer. Since you are installing for the first time, type "Y" then press ENTER. A list of digitizer options appears on the screen. Select "Autodesk Device Interface" and press ENTER.
3. Next, you are prompted for the hexadecimal interrupt code (INT0XXh)<79>. Press ENTER to accept the default of 79 and return to the configuration menu.
4. Select "Exit To Main Menu" and press ENTER.
5. AutoCAD now asks you if you would like to keep configuration changes. Type "Y" for yes and press ENTER to return to the main menu.

The configuration is complete; you are now ready to use your Summagraphics tablet with AutoCAD. You may change your tablet size, serial port, or pointing device at any time by returning to the "Configure Digitizer" section and answering "NO" when AutoCAD asks if you want a new driver.

4.2.5 Using DGPMG.EXP

Below are instructions for installing the protected mode ADI driver. These instructions assume that you are installing the driver for use with AutoCAD. If you are using a different Autodesk product, refer to the specific product's documentation for installation information.

There are two methods for installing protected mode drivers in AutoCAD release 11.

Method A:

- Copy the driver file from the Drivers/Utilities disk to your AutoCAD directory without changing the file's name:

```
COPY A:\ADIDVR\DGPMG.EXP C:\ACAD
```

- Next, edit the AUTOEXEC.BAT file. Add the environment variable DGPADI and set it to the full path name of DGPMG.EXP:

```
SET DGPADI=C:\ACAD\DGPMG.EXP
```

Note: When editing the AUTOEXEC.BAT file, ensure that there are no spaces or tabs around the "=". Also, if you have many environment variables set, be sure to add the DGPADI variable in front of them.

- Restart your computer. The DGPADI variable will be recognized by DOS and AutoCAD.

Method B:

- Copy DGPMG from the Summagraphics Drivers/Utilities disk to the \ACAD directory on your hard disk and rename it to "ADIDIG.EXP".

```
COPY A:\ADIDVR\DGPMG.EXP C:\ACAD\ADIDIG.EXP
```

4.2 Summagraphics Driver For Autodesk Applications

4.2.6 Configuring AutoCAD For Use With DGPMG.EXP

After you have installed the ADI driver, and restarted your computer, start up AutoCAD and follow the instructions listed below.

1. Select "Configure AutoCAD" from the screen menu. A listing of the current configuration appears on screen. Press ENTER to proceed to the configuration menu.
2. At the configuration menu, select "Configure Digitizer". AutoCAD asks if you want a new digitizer. Since you are installing for the first time, type "Y" then press ENTER. A list of digitizer options appears on the screen. Select "ADIP386 digitizer" and press ENTER.
3. Next, you are prompted for the size of your tablet. Nine options appear on the screen. Option number one, "Auto-Detect Microgrid Size" automatically determines how big the tablet is and utilizes the full active area of the tablet. Options two through nine are useful for specifying an active area smaller than the tablet size.
4. Next, you are prompted for the type of pointing device (stylus or cursor) that you are using. AutoCAD will prompt you for the number of buttons on your pointing device. Enter the appropriate number and press ENTER.
5. You are now asked to name the serial port. Type "COM 1" or "COM 2" and press ENTER. If you are using a computer with a non-standard serial port, you may specify the IRQ number and address of the port in hexadecimal by choosing the "Allow Detailed Configuration" option from the configuration menu, then running "Configure Digitizer" as described above.

The configuration is complete: you are now ready to use your Summagraphics tablet with AutoCAD. Return to the main menu and enter "Y" to save changes. You may change your tablet size, serial port, or pointing device at any time simply by returning to the "Configure Digitizer" section and answering "NO" when AutoCAD asks if you want a new driver.

4.3 Summagraphics Tablet Driver/Mouse Emulator

4.3.1 Introduction

The Summagraphics tablet driver/mouse emulator, TABLETMG.COM, allows a Microgrid tablet to emulate a Microsoft Mouse. Use when your application's setup menu includes a listing for TABLETMG.COM or Microsoft® Mouse (MOUSE.COM), and your tablet dip switches are configured as follows:

	1	2	3	4	5	6	7	8
SET 1	ON	OFF	OFF	ON	ON	ON	OFF	OFF
SET 2	ON	OFF	OFF	OFF	OFF	ON	OFF	OFF
SET 3	ON	ON	OFF	OFF	OFF	OFF	ON	OFF

Check your Microgrid III DIP switches to confirm proper settings.

4.3.2 Using TABLETMG.COM

First, make sure that TABLETMG.COM is in the current directory. Then at the DOS prompt type the following:

```
TABLETMG [com port] [stylus/cursor] [tracking] [other options]
```

where [com port], [stylus/cursor], [tracking], and [other options] are replaced with the options listed below. If you type only TABLETMG, the tablet defaults to those options marked with an asterisk (*).

Com Port Option

```
/1          Com 1 *
/2          Com 2
/3          Com 3, only on IBM PS/2 systems
/4          Com 4, only on IBM PS/2 systems
/BAxxxx    selects serial port with a base address of xxxx (address must be in hexadecimal)
/lx        selects serial port with IRQ line number x (2-7)
```

Notes

- When using the BA option (Base Address), all four digits must be specified. (Example: for Com 1 - /BA03F8)
- Use the /BA switch only when the serial port is located at a non-standard address within the computer.

4.3 Summagraphics Tablet Driver/Mouse Emulator

4.3.2 Using TABLETMG.COM

Stylus/Cursor Option

/CP two-button stylus *
/C3 three-button stylus
/C4 four-button cursor
/C16 sixteen-button cursor

/CM#### allows a user-defined mapping of the cursor/stylus buttons. The /CM argument is followed by 1-4 digits that specify which stylus/cursor switches are assigned to standard mouse buttons. Each digit represents the value of a stylus/cursor switch, and its position after the /CM argument represents the mouse button that it is assigned to. The first digit after the /CM argument corresponds to the left mouse button, the second digit to the right mouse button, the third digit to the middle mouse button, and the fourth digit corresponds to an emulation of both the left and right mouse buttons being pressed simultaneously.

Example

TABLETMG /CM2134

The above example shows stylus/cursor switch #2 being mapped to the left mouse button, stylus/cursor switch #1 being mapped to the right mouse button, stylus/cursor switch #3 being mapped to the middle mouse button, and stylus/cursor switch #4 being mapped to both the right and left mouse buttons.

Tracking Options

The following options will work only if the application is set up to use a Microsoft Mouse (MOUSE.COM).

Applications that are compatible specifically with TABLETMG.COM should configure tracking automatically or allow you to configure tracking through the application's set up utility. The use of the following options will be overridden by the application.

Relative Mode /R *

Relative mode is the default setting. There are four relative mode options:

/S## Sets both horizontal and vertical sensitivity - - Range=0-99, default=50

/H## Sets only the horizontal sensitivity - - Range=0-99, default=50.

/V## Sets only the vertical sensitivity - - Range=0-99, default=50.

/M# This option is the ballistic gain profile. It controls acceleration of the screen cursor. The driver comes with four built-in ballistic gain profiles: Slow, Moderate, Fast, and Unaccelerated. Specify 1,2,3, or 4 respectively.

Absolute Mode /A

Absolute mode maps the tablet's entire active area to the computer screen. Relative mode options (/S, /H, /V, /M) should not be used in Absolute mode.

4.3 Summagraphics Tablet Driver/Mouse Emulator

4.3.2 Using TABLETMG.COM (Cont.)

Tracking Options (cont.)

Note: Applications accept input from MOUSE.COM as either absolute screen coordinates, or relative mouse units, also referred to as "mickeys". Absolute mode works only with those applications that accept input as absolute screen coordinates. To verify that absolute mode is working, position the screen pointer, then lift the cursor/stylus out of the tablet's active area and place it at a different location on the tablet. The screen cursor should snap to a new location. If it does not, then the application works only in relative mode and the absolute mode option will have no effect.

Other Options

/O# This option overrides an application that changes the mouse cursor for text modes by "locking" the mouse cursor to the default text cursor. To enable locked cursor type /O1; to disable locked cursor type /O0. The default is /O0.

/N### This option specifies how many screen updates to skip before actually plotting the cursor. This feature is useful for laptop computers and other systems with slower LCD displays. A small value is recommended because driver performance can be affected. ### is a number between 0-255. The default is /N0.

Disabling The Driver

/OFF Disables driver

4.3.3 Examples

For a Microgrid with a sixteen-button cursor attached to Com 1:

```
TABLETMG /1 /C16
```

Sample Batch File

```
TABLETMG /1 /C16      installs driver
CD \PAINTDR           changes to application directory "PAINTDR"
PAINT                 runs application "PAINT"
```

4.3.4 Running The Driver From CONFIG.SYS

Another way to install the driver is by including TABLETMG.SYS as a device driver in the CONFIG.SYS file. In doing so, the system automatically installs the driver each time you boot or turn on the system.

Line Syntax

```
DEVICE=TABLETMG.SYS [com port][stylus/cursor][tracking][other options]
```

Note that the command options are the same as those for running TABLETMG.COM from the DOS prompt or a batch file.

Example

For a Microgrid with a sixteen-button cursor attached to Com 1:

```
DEVICE=TABLETMG.SYS /1 /C16
```

4.4 Summagraphics Driver For Microsoft Windows

4.4.1 Introduction

The Windows driver allows you to use your Microgrid III tablet as a pointing device with the Microsoft Windows software. The Windows driver requires your tablet dip switches to be configured as follows:

	1	2	3	4	5	6	7	8
SET 1	ON	OFF	OFF	ON	ON	ON	OFF	OFF
SET 2	ON	OFF	OFF	OFF	OFF	ON	OFF	OFF
SET 3	ON	ON	OFF	OFF	OFF	OFF	ON	OFF

Check your Microgrid III DIP switches to confirm proper settings.

The Windows driver also requires 100 kilobytes of free hard disk space. Before installing the driver, check for free disk space by issuing the "DIR" command on the target drive. DOS will respond with "nnn bytes free". If there is insufficient disk space, remove or move enough files to accommodate the driver, then run the install program.

4.4.2 Installing The Windows Driver

Below are instructions for installing the Microsoft Windows driver.

Windows must be installed on your system before you can install the Summagraphics Windows driver. If Windows is not installed on your system, follow the installation procedures in your Windows manual.

1. Insert the Summagraphics Drivers/Utilities diskette into your A: drive. At the DOS prompt, type the following:

A: [ENTER]

2. Change to the WINDVR directory by typing the following:

CD WINDVR [ENTER]

3. Next, run the INSTALL program by typing the following:

INSTALL [ENTER]

The INSTALL program installs the Summagraphics Windows driver and the SUMMA.EXE control panel program onto your computer. The INSTALL program prompts you for the following information:

- the hard drive where Windows is installed
- the name of the Windows directory
- whether you want to save (by renaming) the previous version of the drivers or remove them
- the serial communications port to which your graphics tablet is connected

INSTALL then creates a subdirectory called "SUMMA" under the Windows directory, copies the drivers, and starts the Windows SETUP program.

4.4 Summagraphics Driver For Microsoft Windows

4.4.2 Installing The Windows Driver (cont.)

4. In the Windows SETUP program, at the System Information screen, use the up/down arrow keys to highlight the "MOUSE" line and press [ENTER].
5. Use the up/down arrow keys to select "Other (Requires disk provided by a hardware manufacturer)" and press [ENTER].
6. Type the full pathname of the "SUMMA" subdirectory under your Windows directory, e.g.,

C:\WINDOWS\SUMMA [ENTER]

7. Use the up/down arrow keys to select "Microgrid Driver" and press [ENTER].

Note: Some Windows 3.0 installations may experience an anomaly with the Windows Setup program. After entering the pathname to the "SUMMA" directory, the Windows Setup program may respond with a second prompt for the location to the driver and an erroneous pathname.

Example: C:\WINDOWS\SUMMA [ENTER]

To continue, simply backspace over the erroneous pathname and re-enter the proper pathname.

Example: C:\WINDOWS\SUMMA [ENTER]

The Windows Setup program may respond again with the erroneous prompt. Enter the pathname one more time and the Windows Setup program will accept the pathname.

8. Accept the new configuration shown on the screen by pressing [ENTER].

Note: If you are reinstalling the driver, an anomaly with the Windows 3.1 Setup program may occur. After selecting the required driver, the Setup program will prompt again for the location of the driver. To continue, simply re-enter the driver pathname.

Example: C:\WINDOWS\SUMMA [ENTER]

9. Install the Summagraphics Control Panel icon in one of the program manager groups so that it is easily accessible:

- Open Windows.
- Open the Windows Program Manager by double-clicking on its icon.
- Under the FILE pop-down menu, select "New".
- The "New Program Object" dialog box appears. Select "Program Item", then click OK.
- The "Program Item Properties" dialog box appears. Type "SUMMA" in the "Description" box. Next, enter the path name for the Summagraphics Control Panel in the "Command Line" box and click on OK. For example, if Windows is installed on

4.4 Summagraphics Driver For Microsoft Windows

4.4.2 Installing The Windows Driver (cont.)

your C: drive, in a directory called, WINDOWS, you would type the following:

```
C:\WINDOWS\SUMMA.EXE
```

The "SUMMA" icon should appear in the current group's window. If desired, it may be dragged to a different group's window.

10. To run the control panel, click on the "SUMMA" icon.

4.4.3 Modifying Driver Defaults With The Control Panel

The control panel allows you to modify the default driver parameters, including tracking mode, cursor/stylus button definitions, and tablet active area size and positioning. The control panel window contains three utilities - - Information, Features, and Setup. To open one of the utilities, double click on its icon or select its name from the "TABLET" menu. Each of the utilities are explained below.

Using The Information Utility

To open the "Tablet Information" utility, double-click on the Information icon. The "Tablet Information" screen appears, displaying the following information:

- tablet type
- tablet format
- cursor/stylus type
- units pop-down menu
- tablet width and height
- horizontal and vertical resolution

The units pop-down menu allows you to specify the measurement system used to display tablet information: Metric or US.

To close the utility, click on OK.

Using The Features Utility

To open the Features utility, double-click on its icon. The "Features" screen appears, listing your stylus/cursor options. To select a stylus/cursor type, click on the accompanying button. To close the window and save changes made, click on OK. To close the window without saving changes, click on CANCEL.

Using The Setup Utility

To open the "Setup" utility, double-click on its icon. The "Summagraphics Tablet Setup" screen appears, with fields for changing the following tablet parameters: tracking mode, button assignments, and tracking area. When making changes to the "Summagraphics Tablet Setup" screen, click on the following buttons, located at the right-hand side of the window, to save or cancel your changes.

OK - - saves any changes made and closes window.

CANCEL - - closes window without saving changes.

REVERT - - changes settings back to the original ones (those in use when the window was opened).

TEST - - tests a new setting without closing the window.

4.4 Summagraphics Driver For Windows

4.4.3 Modifying Driver Defaults With The Control Panel (cont.)

Modifying The Tracking Mode

You may select one of two different tracking modes:

Relative mode - - Clicking on the "Relative" button changes the tablet to relative tracking (like a mouse). It also activates the "Sensitivity" control. To modify the sensitivity, use the arrow buttons or type in a new value to increase or decrease the tracking sensitivity. The higher the number in the "Sensitivity" box, the faster the screen pointer moves.

Absolute mode - - Clicking on the "Absolute" button changes tablet tracking to absolute. The "Sensitivity" field deactivates and will have no effect on tracking when in absolute mode.

Modifying The Button Assignments

There is one check box and two pop down menus under the "Button Assignments" heading:

Default Check Box - - Changes the button assignments to the default values.

Button Menu - - Lists the buttons on your stylus or cursor.

Button Function Menu - - Lists the functions assigned to each stylus or cursor button.

When the default box is checked, the button assignments are predetermined by the driver. Below is a listing of the default stylus/cursor buttons and their functions.

Default Four-Button Cursor Functions

Button	Function (mouse button)
yellow	left click
white	left double click
blue	right double click
green	right click

Default 16-Button Cursor Functions

Button	Function (mouse button)
1	left click
2	right click
3	left-double click
C	right-double click

Default Two- and Three-Button Stylus Functions

Two-Button Stylus	Three-Button Stylus	Function (mouse button)
tip button	tip button	left click
barrel button		right click
	lower barrel button	left double-click
	upper barrel button	right click

4.4 Summagraphics Driver For Windows

4.4.3 Modifying Driver Defaults With The Control Panel (cont.)

To modify the default button assignments:

1. Click on the default check box until the "X" disappears.
2. Use the Buttons Menu to choose the button you wish to redefine.
3. Use the Button Functions Menu to assign a function to the selected button.
4. Leave the default check box unchecked unless you wish to return to the default settings.

Modifying The Tablet Active Area

There are two ways to modify the tablet active area:

- Enter information in the "Tracking Area" numeric fields on the screen.
- Use the on-screen graphic.

Defining The Active Area Using The "Tracking Area" Numeric Fields

Modify the following fields in the "Tracking Area" to change the size and position of your tablet's active area:

Whole Tablet Check Box - - Click on this button to map the entire tablet to the screen. When this button is activated, the remaining tracking area controls are inoperative.

Preserve Aspect Ratio Button - - Click on this button to modify the current tablet active area so that it has the same aspect ratio as the computer screen. Aspect ratio is the ratio between the horizontal and vertical dimensions of your computer screen. The dimensions of the tablet active area you define must have the same aspect ratio as your computer screen or circles drawn on the tablet will appear as ovals on the screen and vice versa.

Note: Aspect ratio cannot be guaranteed in a Windows environment because pixel shapes may vary from monitor to monitor, causing graphics to be distorted. You may need to make adjustments to your system to ensure proper aspect ratio.

Units Menu - - Specifies the measurement system used to display tablet information: metric or US.

Width and Height Controls - - These fields define the size of the tablet active area. Use the arrow buttons or position the screen pointer in the box and enter a value from your keyboard.

Margin Controls - - These fields define the position of the active area on your tablet. Use the arrow buttons or position the screen pointer in the box and enter a value from your keyboard.

4.4 Summagraphics Driver For Windows

4.4.3 Modifying Driver Defaults With The Control Panel (cont.)

Defining The Active Area Using The On Screen Graphic

The tracking area box in the lower right-hand corner of the tracking area panel represents the entire tablet active area. The shaded area within this box represents the current user-defined active area. Position the screen pointer inside of the tracking area box and click. Two things happen: the screen pointer changes from an arrow to a cross hair, and the entire box becomes shaded.

Note: If you do not define the active area within approximately seven seconds, the cross hair changes back to an arrow and it is necessary to click inside the tracking area box again.

To define the active area:

1. Position your cursor on the lower left corner of the active area you wish to define and click.
2. Position your cursor on the upper right corner of the active area you wish to define and click.
3. Click on "Test" to test the new active area. The new active area does not take effect until you click on "Test" or "OK".

Hint: To aid in defining your active area, cut a piece of scrap paper to the size of the active area you wish to define, position it on your tablet, and secure with tape. Now, follow steps 1-3 above to define the active area.

4.5 Testing The Tablet: The MG3TEST Utility

4.5.1 Introduction

MG3TEST is a diagnostic and data display program for the Microgrid III. Use it to verify that your Microgrid III tablet is functioning properly. MG3TEST requires that your tablet is properly connected to Com 1 or Com 2, powered on, and the dip switches configured as follows:

	1	2	3	4	5	6	7	8
SET 1	ON	OFF	OFF	ON	ON	ON	OFF	OFF
SET 2	ON	OFF	OFF	OFF	OFF	ON	OFF	OFF
SET 3	ON	ON	OFF	OFF	OFF	OFF	ON	OFF

4.5.2 Running MG3TEST

To run MG3TEST, type the following at the DOS prompt:

```
MG3TEST [option]
```

```
option: /1 = com port 1  
        /2 = com port 2
```

The MG3TEST program identifies your tablet type and asks you to confirm the information. For example:

```
You have a UIOF-format tablet, 36 x 48 inches: Correct? (Y/N)
```

If this information is correct, the MG3TEST main menu will appear. If the information is not correct, or if the program is unable to identify your tablet, the program will prompt you for the following information: Parity, baud rate, X-axis size, Y-axis size, and number of stop bits.

4.5.3 The MG3TEST Main Menu

You may enter one of three choices from the main menu: Diagnostic Tests, Display Coordinates, and Quit.

```

                                     Main Menu
                                     1. Diagnostic Tests
                                     2. Display Coordinates
                                     3. Quit
                                     Enter Choice (1 - 3):

MGIII Test Version X.XX   Copyright Summagraphics Corporation
```

4.5 Testing The Tablet: The MG3TEST Utility

4.5.3.1 Display Coordinates Option

If you enter 2, "Display Coordinates", the following screen appears:

```

                                UIOF Format
                                X: 12.519      Y: 15.145
                                Coordinates are in inches
                                Proximity: In Prox      Tablet Identifier: Disabled
                                Buttons: 0      00000000
                                Tablet Size: 20.00 (X) by 20.00 (Y) Inches
                                Tablet Resolution: 1000 (X) by 1000 (Y) lines per inch
                                Coordinates in inches / centimeters / counts: <F1> to change
                                Press <ESC> to return to Main Menu.
```

Perform the following tests to make sure your tablet and cursor are functioning properly. Make notes of any problems or discrepancies.

- Coordinates - - Move your cursor across the tablet and watch the X and Y coordinates change on the screen. Ensure that the coordinates are accurate. e.g. If the tablet is 36" x 48" in size, the X coordinates must go from 0 to 48" and the Y coordinates must go from 0 to 36". Note that coordinates may be reported on the screen in inches, centimeters, or counts. You may switch between the different units of measurement by using the <F1> function key.
- Proximity - - Move your cursor out of proximity. The proximity status on the screen should change accordingly.
- Tablet Identifier - - The tablet identifier should always be disabled.
- Cursor Buttons - - Press each cursor button. The number of the button being pressed should appear in the button field on the screen. The binary equivalent appears to the right of the button number.
- Tablet Size/Resolution - - Review the tablet size and tablet resolution fields to ensure the information shown on the screen is correct.

Make a note of any problems that occurred while performing the above tests and continue to the MG3TEST diagnostic tests. To run the diagnostic tests, press <ESC> to return to the main menu and enter option 1.

4.5 Testing The Tablet: The MG3TEST Utility

4.5.3.2 Diagnostic Tests Option

To run the diagnostic tests, enter 1, "Diagnostic Tests", from the main menu. The Diagnostic Test Menu appears.

Diagnostic Test Menu

1. Execute Diagnostics
2. Read Configuration
3. Return to Main Menu

Enter Choice (1 - 3):

If you select 2, "Read Configuration", the Read Configuration screen appears. Use this screen to confirm that your DIP switches are set properly and that your tablet is configured properly.

Tablet Configuration								
Switch #	1	2	3	4	5	6	7	8
DIP #1	On	Off	Off	On	On	On	Off	Off
DIP #2	On	Off	On	Off	Off	On	Off	Off
DIP #3	On	On	Off	On	Off	Off	On	Off

Baud Rate9600	ParityEven
Stop Bits2	Data Bits7
Transmission Transmit whether or (Prox) not in Proximity	Report Format Binary
Transmission Transmit only when (Margin) in Margin	ASCII Counts/Inches Counts
Emulation MG / UIOF	ASCII Decimal Point Excluded
Mode Stream Mode	ASCII<LF >Terminator Included
Echo Off	Dual XDCR Select
Resolution 1000 lines per inch	XDCR Select Cursor
	Customized Option Disabled

Press any key to return to Diagnostics Menu

4.5 Testing The Tablet: The MG3TEST Utility

4.5.3.2 Diagnostic Tests Option (cont.)

If you select 1, "Execute Diagnostics", the "Microgrid Diagnostic Tests" screen appears.

```

                                Microgrid Diagnostic Tests

Version.....X

Controller Diagnostics
RAM Memory Test .....PASS
ROM Memory Checksum.....XX

Tablet Diagnostics
X - Axis .....PASS
Y - Axis .....PASS

                                Press any key to view Grid Diagnostics.
```

This screen shows the current version of the firmware as well as the results of the controller diagnostics tests and the tablet diagnostics tests. If your tablet PASSES these tests it is functioning properly.

If your tablet FAILS the RAM memory test, record the ROM checksum number that appears on your screen. Next, press any key to return to the Diagnostics Main Menu and contact the Summagraphics Customer Service Department. Refer to Part I, Chapter 5, for further information on service.

If your tablet FAILS the tablet diagnostics test, a message will appear indicating where the problem is located. For example:

There is a problem in the X- and/or Y-axis

If the problem is located in the tablet grid, you will be prompted to view the grid diagnostics. A screen appears for both the X and Y axes.

Note the axis, the set, and the wire numbers where "Xs" and/or "Ys" appear on the screen. Write down this information and contact the Summagraphics Customer Service department. Refer to Part I, Chapter 5, for further information on service.

4.6 Resetting The Tablet: The UIOFRST Utility

4.6.1 Introduction

The UIOFRST utility resets a Microgrid tablet with dip switches configured as follows:

	1	2	3	4	5	6	7	8
SET 1	ON	OFF	OFF	ON	ON	ON	OFF	OFF
SET 2	ON	OFF	OFF	OFF	OFF	ON	OFF	OFF
SET 3	ON	ON	OFF	OFF	OFF	OFF	ON	OFF

4.6.2 Running UIOFRST

To run UIOFRST, type the following at the DOS prompt:

UIOFRST [options]

where [options] is replaced with one of the options listed below. The utility program defaults to those options marked with an asterisk (*).

Options

/1 selects serial port 1 (PC, XT, AT, PS/2) *
/2 selects serial port 2 (PC, XT, AT, PS/2)
/3 selects serial port 3 (PS/2 only)
/4 selects serial port 4 (PS/2 only)
/5 selects serial port 5 (PS/2 only)
/6 selects serial port 6 (PS/2 only)
/7 selects serial port 7 (PS/2 only)
/8 selects serial port 8 (PS/2 only)
/BAxxxx selects serial port with base address of xxxx
(address must be in hexadecimal)
/N selects no parity configuration
/O selects odd parity configuration
/E selects even parity configuration
/? or /H displays help screen

Notes

- When using the BA option (Base Address), all four digits must be specified. (Example: for COM 1 - /BA03F8)
- This program transmits in the UIOF/Microgrid default serial communication configuration: 9600 baud, 7 data bits, even parity, and 2 stop bits.
- Use the /BA switch only when the serial port is located at a non-standard address within the computer.
- A summary of command line switches is always available by starting the program with switch /? or /H.

4.6.3 Examples

To reset a UIOF/Microgrid format tablet connected to Com 2, type: UIOFRST /2

4.7 Changing Tablet Parameters: The SEND Utility

4.7.1 Introduction

SEND.COM is a tablet configuration utility. This utility sends a string of commands to Microgrid III tablets to modify the default tablet settings. For a complete UIOF command summary, refer to Part II, Chapter 2: "Microgrid III Output Formats."

4.7.2 Running SEND.COM

To run SEND.COM, type the following at the DOS prompt:

SEND [options]

where [options] is replaced with the options listed below. If you type only SEND, the tablet will return an error message. The /Cx . command switch is required. The default options are marked with an asterisk (*).

Options

/1	selects serial port 1 (PC, XT, AT, PS/2) *
/2	selects serial port 2 (PC, XT, AT, PS/2)
/3	selects serial port 3 (PS/2 only)
/4	selects serial port 4 (PS/2 only)
/5	selects serial port 5 (PS/2 only)
/6	selects serial port 6 (PS/2 only)
/7	selects serial port 7 (PS/2 only)
/8	selects serial port 8 (PS/2 only)
/M	selects MM format serial configuration *
/U	selects UIOF format serial configuration
/E	modify serial configuration to even parity
/N	modify serial configuration to no parity
/O	modify serial configuration to odd parity *
/BAxxxx	selects serial port with base address of xxxx (address must be in hexadecimal)
/Cxxx .	transmit command characters "xxx ." until carriage return (required options)
? or /H	displays help screen

Notes

- SEND.COM can transmit at various baud rates and parities, and can transmit commands from an ASCII file. For further information, refer to SEND.DOC, or invoke SEND.COM with the "Help" option (example: SEND ?).
- When using the BA option (Base Address) all four digits must be specified (example: for Com 1 - /BA03F8).
- Option /C must be the last option on the command line. There is no space between the /C switch and the commands that follow.
- To transmit ASCII control characters, precede a printable ASCII character with "^" (examples: ESC = ^[, NULL = ^@, BELL = ^G)

4.7 Changing Tablet Parameters: The SEND Utility

4.7.2 Running SEND.COM (cont.)

Notes (cont.)

- The /BA option should only be used when the serial port is located at a non-standard address within the computer.
- A summary of command line switches is always available by starting the program with the /? or /H options.

4.7.3 Examples

Sample Batch File 1

```
SEND /2 /U /E /C^Z  
CD C:\APDIR  
APPLICATION
```

*resets a UIOF tablet on com 2 (even parity)
changes to the application directory "APDIR"
name of your application here; runs the application*

Sample Batch File 2

```
SEND /1 /U /C^M0  
CD C:\CADKEY3  
CADKEY
```

*sends a stream mode command to the tablet on Com 1
changes to application directory "CADKEY3"
runs application "CADKEY"*

Sample Batch File 3

```
SEND /1 /U /C^M0  
CD C:\VCAD52  
VCAD52
```

*sends a stream mode command to the tablet on Com 1
changes to application directory "VCAD52"
runs application "VCAD52"*

Chapter 5

Maintenance and Troubleshooting

Chapter 5 provides basic guidelines for cleaning and maintaining your Microgrid III tablet, as well as information on troubleshooting and service.

5.1	Routine Maintenance.....	46
5.1.1	Cleaning the Microgrid III	46
5.1.2	Cursor Care	46
5.1.3	Stylus Care.....	46
5.2	Diagnostics and Troubleshooting.....	47
5.2.1	Power-Up Diagnostics	47
5.2.2	Troubleshooting	47

5.1 Routine Maintenance

5.1.1 Cleaning the Microgrid III

Follow these guidelines when cleaning the Microgrid III.

- Turn the tablet and computer off and unplug them both before cleaning.
- Using a soft, damp (not wet) lint-free cloth, wipe clean with a mild detergent solution. Never use a hydrocarbon cleaner such as acetone, or an abrasive cloth. These mar the tablet finish.
- Never immerse the tablet in liquid.

5.1.2 Cursor Care

The transparent part of the cursor that encases the cross hair is called the paddle. Protect the paddle. Do not scratch, mar, or separate. To clean, wipe with a lint-free cloth dampened with water. Do not use any other type of cleaner or solvent.

5.1.3 Stylus Care

The only maintenance required on the stylus is to change the stylus refill. Stylus refills are obtained from your Summagraphics dealer. To change the refill, unscrew the cap and pull the refill straight out. Insert the new refill and screw on the cap.

5.2 Diagnostics and Troubleshooting

5.2.1 Power-Up Diagnostics

When you power up the Microgrid III, it performs self diagnostics. When the tablet completes the power up diagnostics, it emits three tones, telling you that everything is functioning properly. If you hear only one or two tones when powering up your Microgrid III, or no tones at all, your tablet is not functioning properly.

5.2.2 Troubleshooting

If you are having a problem with your Microgrid III tablet, please check the following:

- Check the hardware connections.
- Check the DIP switches to confirm proper settings.
- Reset your system by turning the computer off and on, and run the MGIII TEST program (found on the Summagraphics Drivers/Utilities Diskette).

If your tablet is still malfunctioning, contact our Sales Support department:

N. America/Asia Pacific/S. America

Europe/Middle East/Africa

Summagraphics Corporation
60 Silvermine Road
Seymour, Connecticut 06483

Summagraphics Ltd.
12 Richfield Avenue
Reading, Berkshire
England, RG1 8EQ

Phone: (203) 881-5400
Fax: (203) 881-5367

+ 44-(0)734-567115
+ 44-(0)-734-588300

When contacting us by mail, please complete the Software Change Request form supplied at the end of this chapter.

When contacting us by phone, please have ready the information requested in the Software Change Request form. This will speed the process.

Part II

Microgrid III Programming Reference

Part II is a technical reference designed for advanced users and software developers. It covers the Microgrid III commands, the Microgrid III output formats, and guidelines for writing software drivers.

Additional technical information, including interfacing hardware, DIP switch settings, and specifications may be found in "Part III: Appendices".

You'll find the following chapters in Part II:

Chapter 1	Microgrid III Commands
Chapter 2	Microgrid III Output Formats
Chapter 3	Guidelines For Writing A Software Driver

Chapter 1

Microgrid III Commands

This chapter provides a detailed summary of each Microgrid command, including command description, when to use, and command syntax.

1.1	Reset Command.....	52
1.2	Change Emulation Command.....	53
1.3	Communication Protocol Commands.....	54
1.4	Data Format Commands.....	56
1.5	Report Modes: Overview.....	58
1.6	Report Modes: Prompt.....	59
1.7	Report Modes: Point.....	60
1.8	Report Modes: Stream and Switch Stream.....	61
1.9	Report Modes: Set Report Rate.....	62
1.10	Report Modes: Increment.....	63
1.11	Proximity Transmission Command.....	64
1.12	Transmission Control: Stop and Start.....	65
1.13	Select Transducer Command.....	66
1.14	See-Thru Command.....	67
1.15	Sound Annunciator Commands.....	68
1.16	LED Control Command.....	69
1.17	Relocate Origin Command.....	70
1.18	Resolution Commands: Fixed Resolution.....	71
1.19	Resolution Commands: Variable Resolution.....	72
1.20	Resolution Commands: Confirm Resolution.....	73
1.21	Skew Correction Command.....	74

1.1 Reset Command

1.1.1 Description

The Reset command is used to reinitialize the Microgrid III system. After receiving a Reset command, the Microgrid III performs internal diagnostics and sets the communications protocol, report format, and other features to match the DIP switch settings. A second command, Change Reset Character, allows you to change the reset character.

1.1.2 When To Use

The tablet is reset every time it is turned on. Many applications also reset the tablet to meet their specific configuration requirements. Use Reset in the following situations:

Reset: Use to reset the Microgrid III communications protocol, report format, and other features to match the DIP switch settings. The tablet will default to these settings when powered up.

Change Reset Character: This command is used to prevent an application from resetting the tablet, thus deleting any special functions (e.g. skew correction) you may have enabled. Send the Change Reset Character prior to starting the application. Summagraphics recommends that you use non-letter characters (e.g. \$ or #).

1.1.3 Command Syntax

Reset	<ESC>Z
Change Reset Character	<ESC>r(x) x = new reset character

1.2 Change Emulation Command

1.2.1 Description

The Microgrid III supports several different output formats: Microgrid UIOF, GTCO, MM (SummaSketch) and Calcomp. Use this command to switch between the different format emulations.

Refer to Part II, Chapter 2, for further information about the Microgrid UIOF format. Refer to Appendix D for further information about the GTCO output format, and to Appendix E for further information on the Calcomp output format.

1.2.2 Command Syntax

Change Emulation	<ESC> z(n)
Microgrid UIOF	n=0
Calcomp	n=2
GTCO	n=3
MM	n=4

1.3 Communication Protocol Commands

1.3.1 Description

These commands are used to change the Microgrid III communication protocols from the host.

1.3.2 When to Use

You need to change the communication protocols when you are working with multiple applications that require different information, such as baud rate, parity, and number of data bits.

1.3.3 Baud Rate

Baud rate refers to the number of bits transmitted each second between your host and the Microgrid III, or between the Microgrid III and your host. The available Microgrid baud rates, along with their corresponding ASCII commands and DIP switch settings, are listed in the table below.

Command Name	ASCII Format	Switch Settings - DIP Switch # 1							
Baud Rate	<ESC>B (n)	1	2	3	4	5	6	7	8
19,200	n=0	OFF	OFF	OFF	-	-	-	-	-
9600	n=1	ON	OFF	OFF	-	-	-	-	-
4800	n=2	OFF	ON	OFF	-	-	-	-	-
2400	n=3	ON	ON	OFF	-	-	-	-	-
1200	n=4	OFF	OFF	ON	-	-	-	-	-
600	n=5	ON	OFF	ON	-	-	-	-	-
300	n=6	OFF	ON	ON	-	-	-	-	-
150	n=7	ON	ON	ON	-	-	-	-	-
110	n=8	-	-	-	-	-	-	-	-

1.3 Communication Protocol Commands

1.3.4 Parity, Data Bits, and Stop Bits

Parity

Parity is an error detection system. When parity is enabled, a 1-bit is selectively added to a bit pattern, causing the pattern to have either an odd number of 1-bits (odd parity) or an even number of 1-bits (even parity). The receiving hardware (Microgrid tablet or host) checks the number of 1-bits in each pattern and indicates an error condition if a pattern with an even number of 1-bits is found in an odd parity system, or an odd number in an even parity system.

Data Bits

Data bits are the number of bits per data transmission that contain data. The Microgrid III supports either seven or eight data bits.

Stop Bits

Stop bits indicate that a data transmission is complete. They are transmitted with each byte of data. The Microgrid III supports either 1 or 2 stop bits.

The Microgrid III parity, data bit, and stop bit combinations, along with their corresponding ASCII commands and DIP switch settings, are listed in the table below.

Command Name	ASCII Format	Switch Settings - DIP Switch # 1							
Parity and Data Bits	<ESC>p(n)	1	2	3	4	5	6	7	8
Parity Disabled	n=0	-	-	-	-	OFF	-	-	-
Odd Parity	n=1	-	-	-	OFF	ON	-	-	-
Even Parity	n=2	-	-	-	ON	ON	-	-	-
7 Data Bits	n=3	-	-	-	-	-	-	OFF	-
8 Data Bits	n=4	-	-	-	-	-	-	ON	-
2 Stop Bit	n=5	-	-	-	-	-	OFF	-	-
1 Stop Bits	n=6	-	-	-	-	-	ON	-	-

Note: The total number of parity, data, and stop bits transmitted at one time cannot exceed ten.

1.4 Data Format Commands

1.4.1 Description

The Microgrid III supports two main data formats: ASCII and Binary. Data formats may be selected by DIP switches or by software commands.

ASCII Format: The ASCII format sends one byte for each number and character required. Each character is defined by the International ASCII Standard (See Appendix F for ASCII conversion table.)

Binary Format: There are several different binary formats, all of which have the ability to identify over 64,000 different numbers with only 16 bits. These bits can be transmitted in 2 or 3 bytes, but the report must be decoded. Summagraphics uses an eight-byte format called UIOF. (Refer to Part II, Chapter II, for further information on the UIOF Binary format.)

1.4.2 When to Use

Binary Command: Use this command to change the report format to the Microgrid III eight-byte Binary format. There is no <CR> or <LF> transmitted at the end of each report. This format cannot be modified.

ASCII Command: Use this command to change the report format to ASCII. The following commands are used to modify the ASCII format.

Carriage Return and Line Feed: These commands toggle the carriage return and line feed characters sent at the end of each report. These commands only apply when in the ASCII format.

Change ASCII Delimiter: The default delimiter between the X coordinate, the Y coordinate, and the switch data is a comma ",". Use this command to change the delimiter from a comma to another character. To change the ASCII delimiter, enter <ESC>Dn.

Decimal Point: The default ASCII report does not include the decimal point. To include the decimal point, enter <ESC>d1. To remove the decimal point, enter <ESC>d0.

1.4 Data Format Commands (cont.)

1.4.3 Command Syntax

Command Name	ASCII Format	Switch Settings - DIP Switch #1							
		1	2	3	4	5	6	7	8
Binary	<ESC>MB	-	-	-	-	-	-	-	OFF
ASCII	<ESC>MA	-	-	-	-	-	-	-	ON

		Switch Settings - DIP Switch #2							
		1	2	3	4	5	6	7	8
Line Feed:									
Enable:		-	-	ON	-	-	-	-	-
Disable:		-	-	OFF	-	-	-	-	-
Carriage Return Toggle	<ESC>MR	-	-	-	-	-	-	-	-
Line Feed Toggle	<ESC>ML	-	-	-	-	-	-	-	-
Decimal Point (inches or mm format only)									
Include	<ESC>d1	-	ON	-	-	-	-	-	-
Exclude	<ESC>d0	-	OFF	-	-	-	-	-	-

1.5 Report Modes: Overview

1.5.1 Description

Report modes are used to control the manner and rate by which reports are sent to the host. Different applications have different requirements for accepting data (reports) from the tablet. There are four different report modes: Prompt, Point, Stream, and Switch Stream.

1.5.2 When to Use

Different applications have different requirements for accepting data (reports) from the tablet. See the individual command descriptions for more detailed information on when to use.

1.5.3 Report Mode Command Syntax

Command Name	ASCII Format	Switch Settings - DIP Switch #3							
		1	2	3	4	5	6	7	8
Stream Mode	<ESC>M0	ON	ON	-	-	-	-	-	-
Point Mode	<ESC>M1	ON	OFF	-	-	-	-	-	-
Switch Stream Mode	<ESC>M2	OFF	ON	-	-	-	-	-	-
Prompt Mode	<ESC>M3	OFF	OFF	-	-	-	-	-	-
Send New Report	<ESC>G	-	-	-	-	-	-	-	-
Resend Last Report	<ESC>g	-	-	-	-	-	-	-	-

1.6 Report Modes: Prompt

1.6.1 Description

Prompt mode allows your application to send a prompt to the tablet whenever it is ready to accept a new coordinate. This reduces the amount of unwanted data and allows the application to ignore the tablet when it wants to.

1.6.2 When to Use

Prompt mode can be used to communicate with the majority of applications.

1.6.3 Command Syntax

Prompt Mode	<ESC>M3
Prompt Character: Send new report	<ESC>G
Prompt Character: Resend last report	<ESC>g

1.7 Report Modes: Point

1.7.1 Description

Point mode allows the tablet to send one coordinate each time a cursor or stylus button is pressed.

1.7.2 When to Use

Point mode is best for mapping or other data collection applications; not recommended for cursor steering applications.

1.7.3 Command Syntax

Point Mode <ESC>M1

1.8 Report Modes: Stream and Switch Stream

1.8.1 Description

Stream mode allows the tablet to continually send reports to the host. Switch Stream Mode allows the tablet to send reports to the host whenever a cursor or stylus button is pressed. Both Stream and Switch Stream Mode send out reports at a specified number per second. At 9600 baud the maximum report rate is about 118 reports per second. If this default report rate is too fast for certain applications, you may adjust the report rates using the Set Report Rate commands. (See "Report Modes: Set Report Rate" for more detailed information on using these commands.) Your application will recommend a required report rate.

Both Stream and Switch Stream modes may also be used in combination with Increment Mode, an increment filter that prevents duplicate coordinates from being transmitted to the host. (See "Report Modes: Increment" for more detailed information on using this command.)

1.8.2 When to Use

Stream Mode: This mode is best for applications where speed is important, such as paint programs and handwriting applications.

Switch Stream Mode: This mode is best for handwriting applications.

1.8.3 Command Syntax

Stream Mode	<ESC>M0
Switch Stream Mode	<ESC>M2

1.9 Report Modes: Set Report Rate

1.9.1 Description

The Set Report Rate Command is used to adjust the rate at which reports are sent to the host when the tablet is in Stream or Switch Stream Mode.

1.9.2 When to Use

Use this command when applications require report rates other than the maximum Microgrid report rates.

1.9.3 Command Syntax

Set Report Rate	<ESC>Rn	
	n=0	1 reports per second (rps)
	n=1	2 rps
	n=2	5 rps
	n=3	10 rps
	n=4	30 rps
	n=5	60 rps
	n=6	85 rps
	n=7	100 rps
	n=8	130 rps
	n=9	134 rps (MAX) *

The maximum report rates (when both ports A and B are enabled) are as follows

19,200 baud	134 rps
9,600 baud	100 rps

* Report rate to 150 rps max (with one port enabled):

<ESC> j = enables Port A
<ESC> k = enables Port B
<ESC> i = enables Ports A and B

The Microgrid III defaults to the maximum report rate on power up, or whenever a Reset command is given.

1.10 Report Modes: Increment

1.10.1 Description

Increment Mode is an increment filter. Used in combination with Stream Mode or Switch Stream Mode, this mode prevents duplicate reports from being transmitted to the host. When the tablet is in Increment Mode, it sends a report to the host only after the stylus or cursor has traveled a minimum distance, or increment, in the X or Y direction. This increment is user-defined, and it applies to both the X and Y axes. You may set the increment value to be anywhere between 0 (off) and 255 counts of resolution. Note that if a cursor/stylus button is pushed or released while in increment mode, a report will be sent to the host even if the increment distance has not been met.

1.10.2 When to Use

Use in combination with Stream Mode or Switch Stream Mode to reduce the amount of data output sent to the host.

1.10.3 Command Syntax

Increment Filter

<ESC>I(nnn)

where (nnn) is a three digit value for the increment step, in counts of resolution, from 000 to 255.

1.11 Proximity Transmission Command

1.11.1 Description

The Proximity Transmission Command controls the transmission of reports based on the location of the stylus/cursor (in-prox or out-of-prox). (Refer to Part I, Chapter 3 for a detailed definition of proximity.)

When the stylus/cursor is out of proximity, it transmits the last coordinates recorded while in-prox.

1.11.2 When to Use

With the Proximity Transmission command, you can set up the Microgrid III to:

- always transmit reports, whether the cursor/stylus is in or out of proximity (always transmit)
- transmit reports only when the cursor/stylus is in proximity (in-prox only)

1.11.3 Command Syntax

Command Name	ASCII Format	Switch Settings - DIP Switch # 3							
		1	2	3	4	5	6	7	8
Proximity Transmission									
in-prox only	<ESC>W0	-	-	-	OFF	-	-	-	-
always transmit	<ESC>W1	-	-	-	ON	-	-	-	-

1.12 Transmission Control: Stop and Start

1.12.1 Description

The Stop Transmission and Start Transmission commands act as gates, allowing reports to be sent from the Microgrid III to the host. These commands control data flow, regardless of the report mode. (Stop Transmission and Start Transmission are the equivalents of the transmission protocols XOFF and XON.)

1.12.2 Command Syntax

Stop Transmission (XOFF)	<Ctrl>S
Start Transmission (XON)	<Ctrl>Q

WARNING: Do not precede this command with the <ESC> character.

1.13 Select Transducer Command

1.13.1 Description

The Microgrid III controller supports multiple transducers. (Note that transducer is another name for pointing device.) Therefore, it is necessary to tell the tablet which one you will be using (you may use only one transducer at a time to select points). The Select Transducer command allows you to do this. With this command, you may select which cursor/stylus will be active for point selection when two transducers are plugged into the controller. This command has two modes:

Dual Transducer Automatic: When in this mode, the transducer that is in proximity is the one that is active. If both transducers are out of proximity, the tablet continually monitors the proximity status of both transducers. The first transducer to return to proximity will be "active" until it is taken out-of-prox again.

Note: To ensure proper operation in dual mode, remove the second transducer (the transducer not in use) from the tablet entirely.

Manual Select: When in this mode, the user selects which transducer will be active through software commands or DIP switch settings (see table below).

1.13.2 Command Syntax

Command Name	ASCII Format	Switch Settings - DIP Switch #3							
		1	2	3	4	5	6	7	8
Select transducer (per DIP switch settings)	<ESC>X0	-	-	-	-	-	-	-	-
Four-button cursor	<ESC>X1	-	-	-	-	-	OFF	OFF	-
Two-button stylus	<ESC>X2	-	-	-	-	-	OFF	OFF	-
16-button cursor	<ESC>X3	-	-	-	-	-	OFF	ON	-
Dual transducer automatic	<ESC>X4	-	-	-	-	-	ON	-	-

1.14 See-Thru Command

1.14.1 Description

When the Microgrid is in See Through Mode, data flows through the RS-232-C DTE and DCE ports, in both directions, as though the Microgrid III were not there. The Microgrid III is "asleep"; it sends no reports and receives no commands, except the command that stops See Through Mode. The purpose of See Through Mode is to allow a computer to communicate with the Microgrid and a terminal from just one of its RS-232-C ports.

1.14.2 Command Syntax

Start See Through Mode	<ESC>S
Stop See Through Mode	<ESC>I (vertical line)

1.15 Sound Annunciator Commands

1.15.1 Description

The Microgrid III has a sound annunciator that emits tones. These commands allow you to modify the Microgrid III's sound annunciator to meet the requirements of your specific applications.

1.15.2 When to Use

Use these commands to meet specific application needs, or to change the tone of the annunciator to match your personal preferences.

1.15.3 Command Syntax

Activates the annunciator for approximately one half of a second; emits last tone chosen.

<ESC>A

Selects one of four different tones for the annunciator and sounds that tone.

<ESC>En

n=1 low tone

n=2 medium tone

n=3 high tone

n=4 highest tone

1.16 LED Control Command

1.16.1 Description

The LED Control command allows you to program the LEDs on the sixteen-button cursor. There are three LEDs on the sixteen-button cursor. The default meanings are as follows:

Left Yellow LED - - Indicates which transducer is selected. When this LED is lit, the 16-button cursor is the active transducer. When the LED is off, the other transducer is selected. When the LED is blinking, the tablet is in Dual Transducer mode and neither transducer is in proximity.

Center Green LED - - Indicates proximity for either pointing device.

Right Yellow LED - - You may program this LED with a specific application function.

1.16.2 When to Use

Use to reprogram the LEDs on the 16-button cursor to meet your specific application needs.

1.16.3 Command Syntax

Right off <ESC>L10

Right on <ESC>L11

1.17 Relocate Origin Command

1.17.1 Description

This command allows you to relocate the tablet origin (0.0). The default origin location is the lower left-hand corner of the tablet active area. You may move the origin to either one of four predefined locations, or to a user-defined position anywhere within the tablet active area. The predefined locations are listed below:

- center of tablet
- lower right corner
- upper left corner
- upper right corner
- lower left (default)

1.17.2 How to Relocate the Origin

To relocate the origin to one of the predefined locations, send the appropriate command, listed below under "Command Syntax". To change the origin to a specific user-defined location, follow these steps:

1. Send the command `<ESC>F1` to let the tablet know you are redefining the origin.
2. Position the transducer over the desired origin location.
3. Press a button on the transducer to send the new origin location to the system.

Depending on the origin's location, coordinates can be positive or negative. For example, an origin centered on the tablet establishes four quadrants, where both negative and positive X,Y coordinates can be reported.

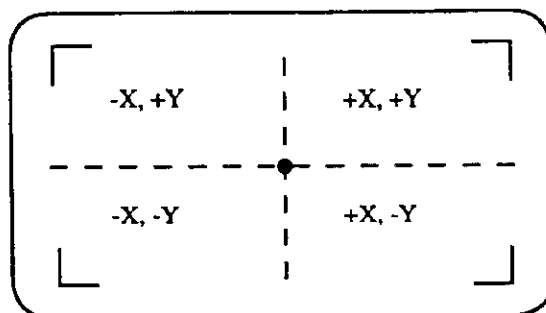

1.17.3 Command Syntax

Relocate Origin	<code><ESC>F [b]</code>
lower left corner	<code>b=0</code>
user-defined	<code>b=1</code>
center	<code>b=2</code>
upper left	<code>b=3</code>
lower right	<code>b=4</code>
upper right	<code>b=5</code>

1.18 Resolution Commands: Fixed Resolution

1.18.1 Description

This command enables you to select the resolution of the Microgrid to meet various application needs. The Microgrid III offers three different fixed resolution settings, in English or metric, which apply to both axes:

	English	or	Metric
•	200 lpi		10 lpmm
•	1000 lpi		40 lpmm
•	2000 lpi		80 lpmm

1.18.2 Command Syntax

Command Name	ASCII Format	Switch Settings - DIP Switch #2							
		1	2	3	4	5	6	7	8
Resolution		-	-	-	ON	-	-	-	-
Metric		-	-	-	OFF	-	-	-	-
English		-	-	-	OFF	-	-	-	-
Fixed Resolution	<ESC>C[b]								
English									
100 lpi	N/A	-	-	-	-	OFF	OFF	-	-
200 lpi	b=0	-	-	-	-	ON	OFF	-	-
1000 lpi	b=2	-	-	-	-	OFF	ON	-	-
2000 lpi	<ESC>CS	-	-	-	-	ON	ON	-	-
Metric									
4 lpmm	N/A	-	-	-	-	OFF	OFF	-	-
10 lpmm	b=1	-	-	-	-	ON	OFF	-	-
40 lpmm	b=3	-	-	-	-	OFF	ON	-	-
80 lpmm	<ESC>CB	-	-	-	-	ON	ON	-	-
Double set resolution	b=6	-	-	-	-	-	-	-	-

1.19 Resolution Commands: Variable Resolution

1.19.1 Description

The Variable Resolution command is used to define the resolution of each axis independently. It allows you to set the resolution to any whole number from 0001 to 1016.

1.19.2 When to Use

Variable Resolution is used to match the tablet resolution to that of a graphics terminal. The resolution of a graphics terminal is measured in pixels, a unit of measurement similar to counts. Therefore, to match the measurement system of the graphics terminal (pixels) to that of the tablet (inches), the Microgrid III automatically changes the report format of the tablet to counts.

1.19.3 Command Syntax

Variable Resolution	<ESC>P[a][b] *
X Axis	a=X b=ASCII value from 0001 to 1016 lpi
Y Axis	a=Y b=ASCII value from 0001 to 1016 lpi

* The command <ESC>C6 doubles resolutions between 2 and 1016 lpi to allow for resolutions greater than 1016 lpi. For example, if you require a resolution of 1600 lpi, set the resolution to 800 lpi and then use <ESC>C6 to double the resolution.

1.20 Resolution Commands: Confirm Resolution

1.20.1 Description

The Confirm Resolution command is used to send a report to the host that specifies the maximum X and Y values at the current resolution setting. When you send a Confirm Resolution command, the tablet dimensions are multiplied by the resolution, and the results are sent to the host in the data format previously selected.

1.20.2 When to Use

Use this command to verify a Variable Resolution setting.

1.20.3 Command Syntax

Confirm Resolution <ESC>a

1.20.4 Example

If you have a 36" x 48" tablet and you send the Confirm Resolution command, the following results are sent to the host (in the data format previously selected):

Resolution = 1000 lpi	48000, 36000
Resolution = 40 lpmm	48768, 36576

1.21 Skew Correction Command

1.21.1 Description

The Skew Correction command is used to align the tablet to a drawing placed upon it by using two points on the drawing as the reference "X-axis".

1.21.2 How to Use

After placing the drawing on the tablet, send the <ESC>x command. The tablet will stop transmitting reports and it will beep to signify that it is ready for the first point. If possible, this first point should be the origin of the drawing. Place the cursor over this point and push any button. The tablet will beep to signify that the tablet is ready for the second point. This point must be on a line parallel to the X-axis from the first point. Place the cursor over this point and push any button. The tablet will beep a third time and resume transmitting data. All of the data will be adjusted so that the first point is the origin and the two points together define the X-axis.

If the first point selected is not the origin, use the <ESC>F1 "User Defined Origin" command after you have performed the skew correction.

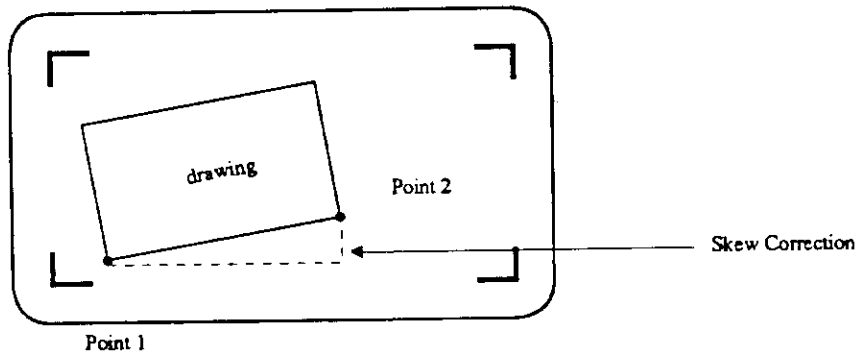

Chapter 2

Microgrid III Output Formats

The Microgrid III supports three different output formats: Microgrid UIOF, GTCO, and Calcomp. The standard Microgrid III format is the Microgrid UIOF format (Universal Input/Output Format). By using the Change Emulation Command (Part II, Chapter 1), or the DIP switches, you may change the output format of your Microgrid III tablet. Within each format, you may choose between ASCII BCD or Binary. This chapter provides the Binary and ASCII information, as well as a command summary, for the Microgrid UIOF format. (Refer to Appendix D for further information on the GTCO output format, and to Appendix E for information on the Calcomp output format.)

2.1	UIOF Output Format.....	76
2.1.1	Overview.....	76
2.1.2	ASCII BCD Report Format.....	76
2.1.3	Packed Binary Report Format	78
2.1.4	UIOF Command Summary	80

2.1 UIOF Output Format

2.1.1 Overview

The Microgrid III report formats conform to Summagraphics' UIOF (Universal Input/Output Format) standards. To accommodate your special needs, you can choose the format to be in ASCII or packed binary.

2.1.2 ASCII BCD Report Format

Within the ASCII BCD report format you can choose:

- the output to be in counts, inches or millimeters.

In units of measure (inches or millimeters), you can also choose the format to include a decimal or not. This does not change the value of the coordinate. For example, 10.123 inches can be reported as either 10123 or 10.123.
- each report to terminate with a <CR><LF> or just a <CR>.
- the delineator to be any ASCII character. (The default is a comma.)

Refer to the key for definitions of the format characters.

For reports, in counts, the format is:

```
SXXXXX,SYYYYY,FF,T<CR><LF>
```

For reports, in counts, with resolutions greater than 1016 lpi, the format is:

```
SXXXXXX,SYYYYYY,FF,T,<CR><LF>
```

For reports in U.S. measure and high resolution (1000 lpi = 39.37 lpmm) or low resolution (200 lpi = 7.874 lpmm), the format is:

```
SXX.XXX.SYY.YYY,FF,T,<CR><LF>
```

For reports in metric measure and high resolution (1016 lpi = 40 lpmm), the format is:

```
SXXXX.XXX,SYYYY.YYY,FF,T,<CR><LF>
```

For reports in metric measure and low resolution (254 lpi = 10 lpmm), the format is:

```
SXXXX.X,SYYYY.Y,FF,T,<CR><LF>
```

Note: Any resolutions above 1016 lpi, as well as 2000 lpi and 80 lpmm, will default to the counts format if ASCII BCD is selected.

2.1 UIOF Output Format

Key

Character	Definition
-----------	------------

S	coordinate sign that can be the ASCII + (positive) or the ASCII - (negative)
X	a digit of the X coordinate, where each digit is an ASCII character, 0 through 9
,	the delineator character. The default is an ASCII comma.
Y	a digit of the Y coordinate, where each digit is an ASCII character, 0 through 9
FF	flag character, identifying the transducer buttons being pressed. The possible combinations are listed in the table below.

3-Button Stylus Buttons	2-Button Stylus Buttons	4-button Cursor Buttons	16-button Cursor Buttons	ASCII Output
none	none	none	none	00
tip	tip	1	1	01
first barrel	barrel	2	2	02
second barrel	tip and barrel	3	3	03
---	---	4	C	04
---	---	---	4	05
---	---	---	5	06
---	---	---	6	07
---	---	---	D	08
---	---	---	7	09
---	---	---	8	10
---	---	---	9	11
---	---	---	E	12
---	---	---	A	13
---	---	---	0	14
---	---	---	B	15
---	---	---	F	16
	when button is pressed and transducer is out of proximity		---	32 plus button output

Note: The cursors are designed for single, not multiple, button use. Pressing multiple buttons simultaneously yields unpredictable results.

T the tablet area identifier, set to 0

<CR> ASCII carriage return

<LF> ASCII line feed

2.1 UIOF Output Format

2.1.3 Packed Binary Report Format

The packed binary report format is in counts, represented in binary notation. The format is the same for any resolution setting.

Stop Bits	MSB	7	6	5	4	3	2	1	LSB	0	Start Bit	Transmission Sequence
SB	P	PH	0	0	0	0	0	T	PR	0	0	1st byte
SB	P	0	0	Fe	Fd	Fc	Fb	Fa	0	0	0	2nd byte
SB	P	0	0	X5	X4	X3	X2	X1	X0	0	0	3rd byte
SB	P	0	0	X11	X10	X9	X8	X7	X6	0	0	4th byte
SB	P	0	0	0	Sx	X15	X14	X13	X12	0	0	5th byte
SB	P	0	0	Y5	Y4	Y3	Y2	Y1	Y0	0	0	6th byte
SB	P	0	0	Y11	Y10	Y9	Y8	Y7	Y6	0	0	7th byte
SB	P	0	0	0	Sy	Y15	Y14	Y13	Y12	0	0	8th byte

Refer to the key on the next page for definitions of each binary report format character.

Binary 8-Byte Format 2000 LPI

		7	6	5	4	3	2	1	0
BYTE 0	P	1	0	0	0	0	0	T	PR
BYTE 1	P	0	0	0	F4	F3	F2	F1	F0
BYTE 2	P	0	0	X5	X4	X3	X2	X1	X0
BYTE 3	P	0	0	X11	X10	X9	X8	X7	X6
BYTE 4	P	0	0	Sx	X16	X15	X14	X13	X12
BYTE 5	P	0	0	Y5	Y4	Y3	Y2	Y1	Y0
BYTE 6	P	0	0	Y11	Y10	Y9	Y8	Y7	Y6
BYTE 7	P	0	0	Sy	Y16	Y15	Y14	Y13	Y12

2.1 UIOF Output Format

Key

Character	Definition
LSB	least significant bit
MSB	most significant bit
PR	proximity, 0 when in proximity and 1 when out-of-prox
T	the tablet area identifier, set to 0
PH	phasing bit, set for 1
P	parity bit
SB	one or two stop bits
F	flag bit, identifying the transducer buttons being pressed. The possible combinations are listed in the table below.

3-Button Stylus Buttons	2-Button Stylus Buttons	4-button Cursor Buttons	16-button Cursor Buttons	Binary Output				
				Fe	Fd	Fc	Fb	Fa
none	none	none	none	0	0	0	0	0
tip	tip	1	1	0	0	0	0	1
first barrel	barrel	2	2	0	0	0	1	0
second barrel	tip& barrel	3	3	0	0	0	1	1
---	---	4	C	0	0	1	0	0
---	---	---	4	0	0	1	0	1
---	---	---	5	0	0	1	1	0
---	---	---	6	0	0	1	1	1
---	---	---	D	0	1	0	0	0
---	---	---	7	0	1	0	0	1
---	---	---	8	0	1	0	1	0
---	---	---	9	0	1	0	1	1
---	---	---	E	0	1	1	0	0
---	---	---	A	0	1	1	0	1
---	---	---	0	0	1	1	1	0
---	---	---	B	0	1	1	1	1
---	---	---	F	1	0	0	0	0

Note: The cursors are designed for single, not multiple, button use. Pressing multiple buttons simultaneously yields unpredictable results.

X0 to X15	X coordinate bits
Y0 to Y15	Y coordinate bits
X0 to Y0	least significant digits
X15 to Y15	most significant digits
Sx and Sy	sign bits for each coordinate where 0 is positive and 1 is negative

2.1 UIOF Output Format

2.1.4 UIOF Command Summary

Command	ASCII	Command	ASCII
Reset	<ESC>Z	2 rps	n=1
Change Emulation	<ESC>z(n)	5 rps	n=2
MG UIOF	n=0	10 rps	n=3
CalComp	n=2	30 rps	n=4
GTCO	n=3	60 rps	n=5
Change Reset Character	<ESC>r(x)	85 rps	n=6
	x=new character	100 rps	n=7
Baud Rate	<ESC>B(n)	130 rps	n=8
19.2K	n=0	143 rps	n=9
9600	n=1	Transmit In-Prox Only	<ESC>W0
4800	n=2	Always Transmit	<ESC>W1
2400	n=3	Stop Transmission	<Ctrl>S
1200	n=4	Start Transmission	<Ctrl>Q
600	n=5	Sound Annunciator	
300	n=6	Standard Tone	<ESC>A
150	n=7	Select Different Tone	<ESC>Y(n)
110	n=8	low tone	n=1
Parity	<ESC>p(n)	medium tone	n=2
Disabled	n=0	high tone	n=3
Odd Parity	n=1	highest tone	n=4
Even Parity	n=2	Relocate Origin	<ESC>F[b]
7 Data Bits	n=3	Lower Left	b=0
8 Data Bits	n=4	User-Defined	b=1
2 Stop Bits	n=5	Center	b=2
1 Stop Bit	n=6	Lower Right	b=4
Data Format		Upper Left	b=3
Binary	<ESC>MB	Upper Right	b=5
ASCII	<ESC>MA	Fixed Resolution	<ESC>C[b]
Binary to ASCII	<ESC>Q	English	
Carriage Return Toggle	<ESC>MR	200 lpi	b=0
Line Feed Toggle	<ESC>ML	1000 lpi	b=2
Decimal Point		2000 lpi	<ESC>CS
Include	<ESC>d1	Metric	
Exclude	<ESC>d0	10 lpmm	b=1
Report Modes		40 lpmm	b=3
Stream Mode	<ESC>M0	80 lpmm	<ESC>CB
Point Mode	<ESC>M1	Double Resolution	b=6
Switch Stream Mode	<ESC>M2	Variable Resolution	<ESC>P[a][b]
Prompt Mode	<ESC>M3	X Axis	a=X
Increment Mode	<ESC>I(nnn)		b=ASCII Value
Send New Report	<ESC>G		from 0001 to 1016
Resend Last Report	<ESC>g	Y Axis	b=ASCII Value
LED Control Command			from 0001 to 1016
Right Off	<ESC>L10	Confirm Resolution	<ESC>a
Right On	<ESC>L11	See-Thru Command	
Set Report Rate	<ESC>R(n)	Start	<ESC>S
1 report per second (rps)	n=0	Stop	<ESC>I

Chapter 3

Guidelines For Writing a Software Driver

If the Microgrid III is connected to a computer, rather than to a terminal, the computer must have a driver for the Microgrid III. The driver is a software subroutine that collects and decodes Microgrid III reports for use by another (master) program. This chapter provides some guidelines, in the form of flowcharts, for writing a driver.

The flowcharts are for a Microgrid III using the Summagraphics UIOF packed binary report format. The steps are general for any set of operating characteristics.

Note: In the context of these charts, "normalize" means to combine the coordinate bytes into the format required by your master program.

3.1	Flowcharts For Writing Drivers	82
3.1.1	General Flowchart For Master Program to Read and Process Digitizer Reports	82
3.1.2	Detail A: Get Binary Format Report.....	83
3.1.3	Detail B: Get Binary Format Report, Poll/Remote Mode or Stream Mode.....	84
3.1.4	Detail C: Get Byte From Tablet	85
3.1.5	Detail D: Normalize Bytes Into X and Y Coordinates, Switch and Proximity Information.....	86

3.1 Flowcharts For Writing Drivers

3.1.1 General Flowchart For Master Program to Read and Process Digitizer Reports

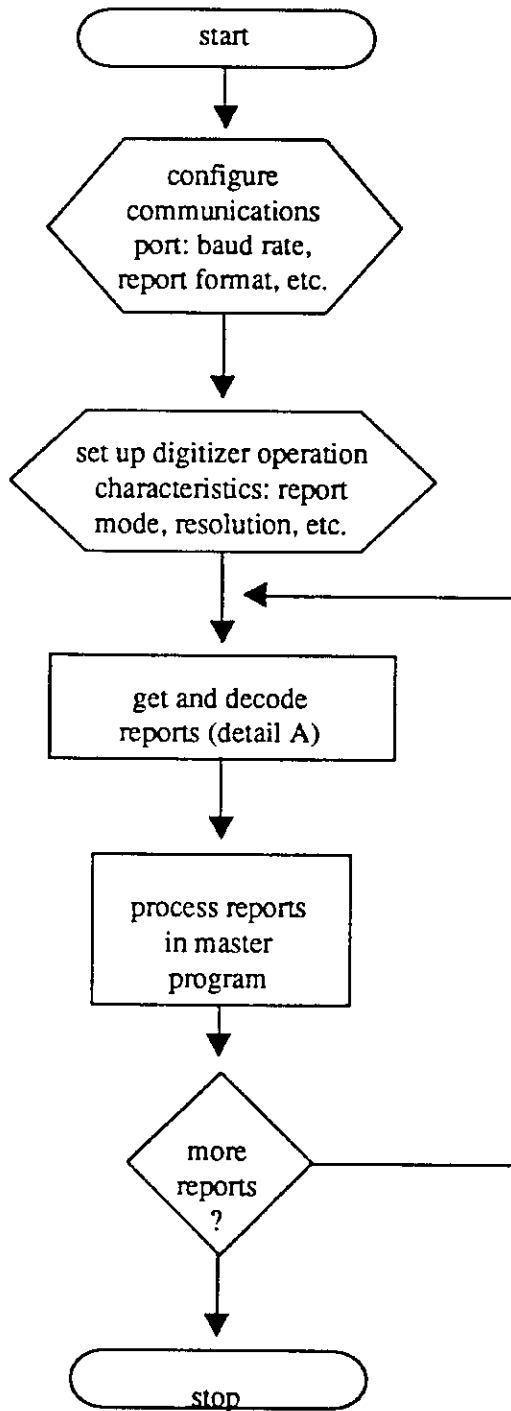

3.1 Flowcharts For Writing Drivers

3.1.2 Detail A: Get Binary Format Report

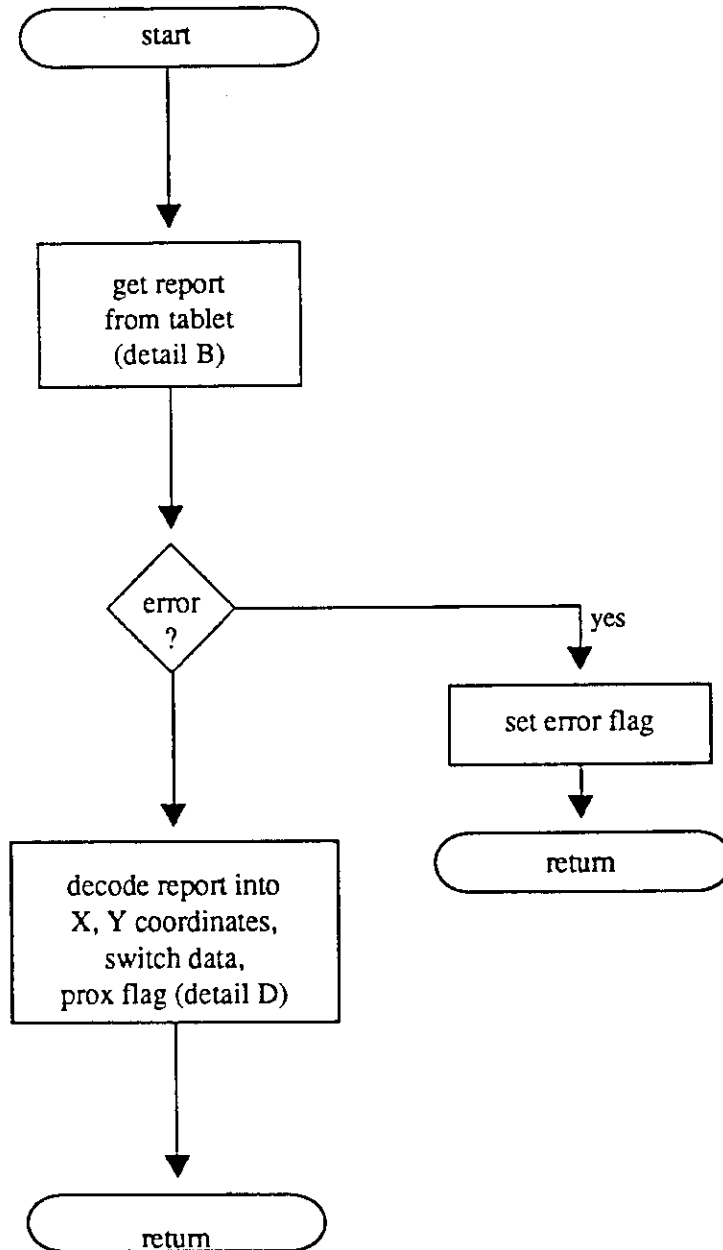

3.1 Flowcharts For Writing Drivers

3.1.3 Detail B: Get Binary Format Report, Poll/Remote Mode or Stream Mode

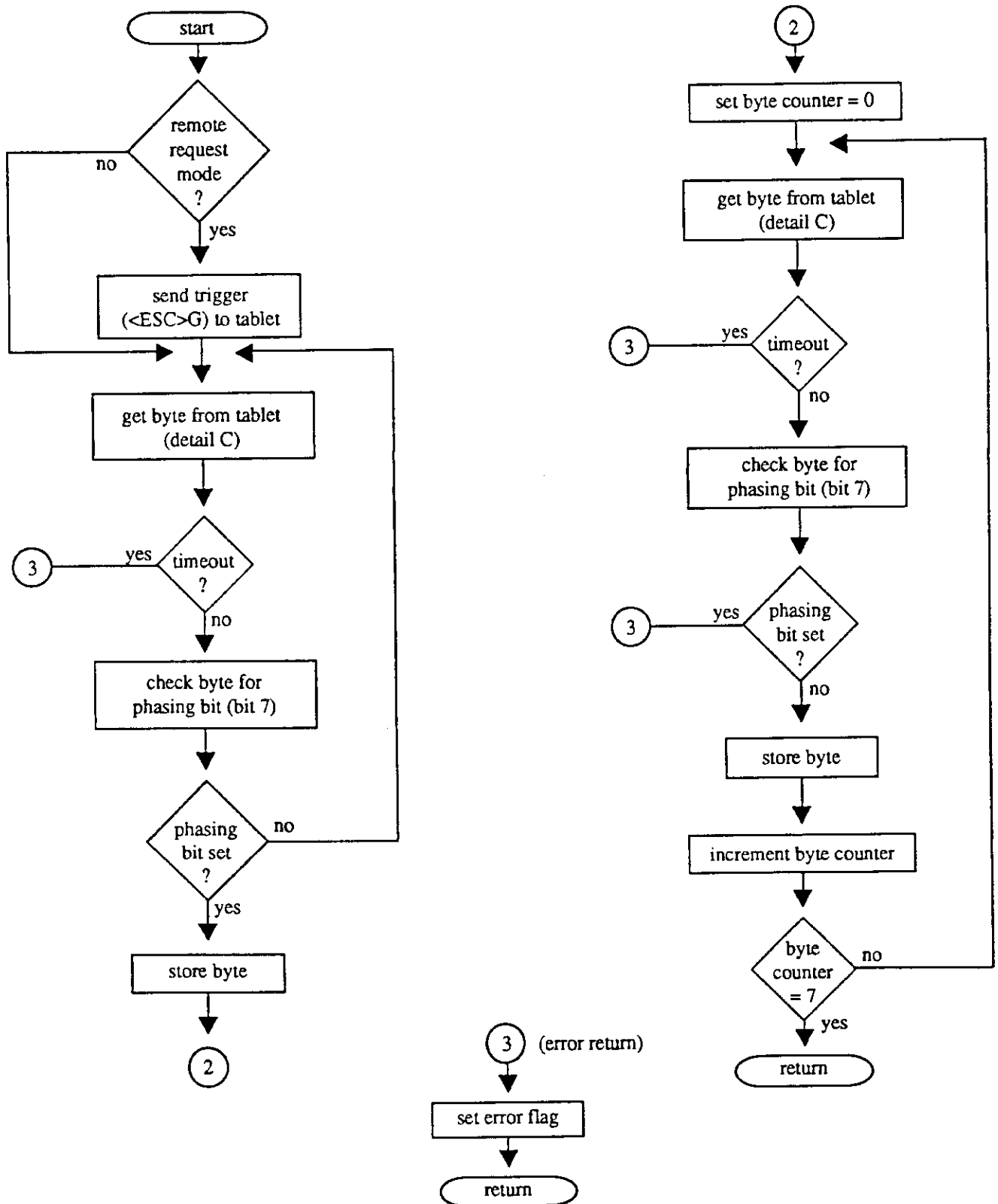

3.1 Flowcharts For Writing Drivers

3.1.4 Detail C: Get Byte From Tablet

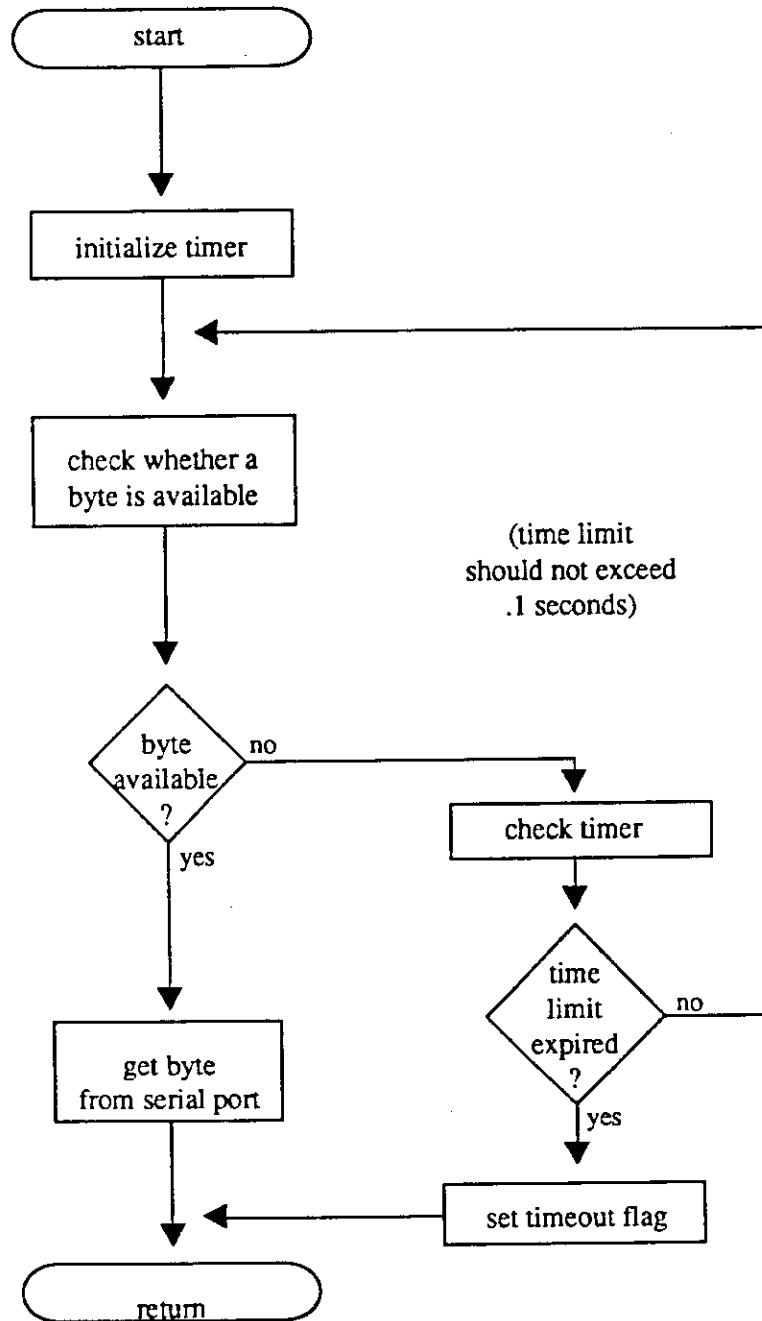

3.1 Flowcharts For Writing Drivers

3.1.5 Normalize Bytes Into X and Y Coordinates, Switch and Proximity Information

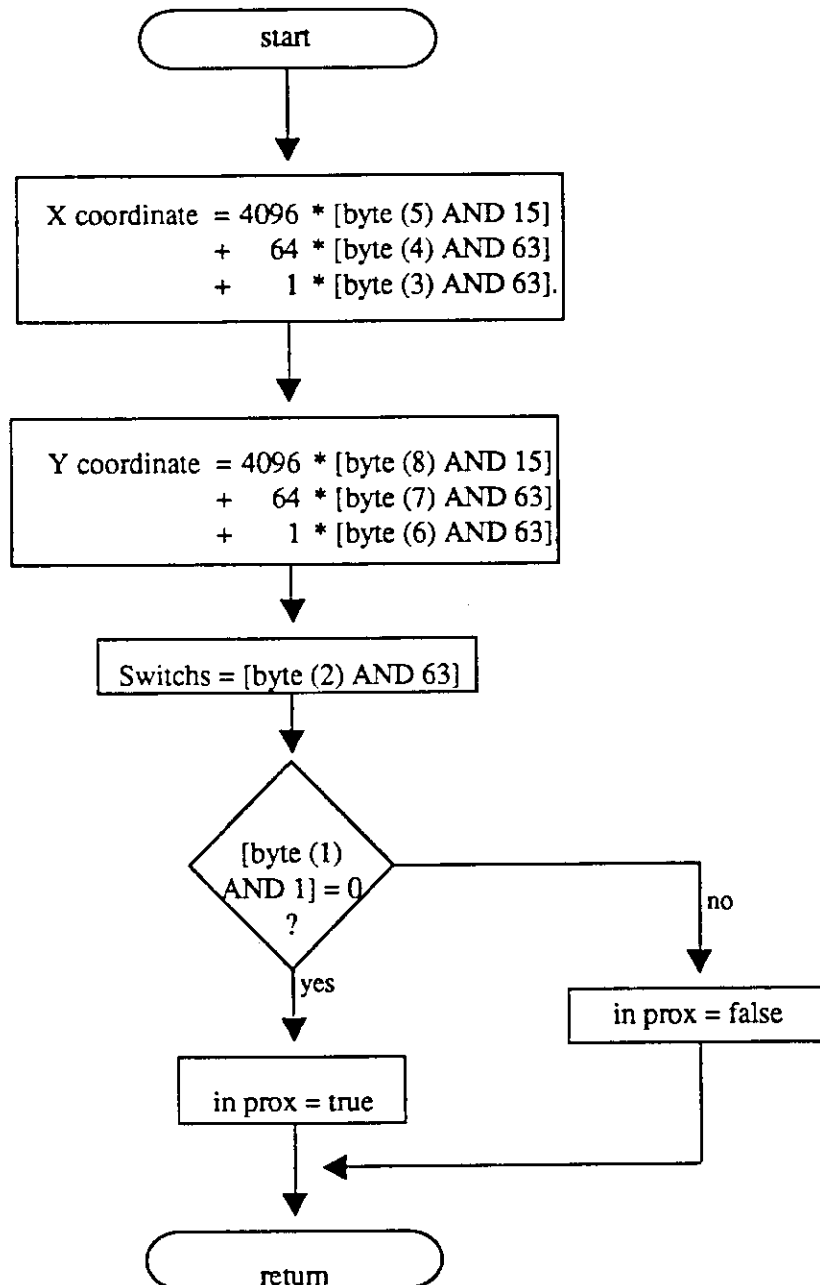

Part III Appendices

Part III provides technical information about the Microgrid III. You'll find the following appendices in Part III:

- Appendix A Microgrid III Interfacing Hardware
- Appendix B Microgrid III DIP Switch Settings
- Appendix C Microgrid III Specifications
- Appendix D GTCO Format Emulation
- Appendix E Calcomp Format Emulation
- Appendix F MM/Summasketch Format Emulation
- Appendix G ASCII Conversion Chart
- Appendix H Microgrid III Application Set Up

Appendix A

Microgrid III Interfacing Hardware

A.1	Microgrid III Interfacing Hardware.....	90
A.1.1	RS-232 Hardware Interface.....	90
A.1.2	RS-232-C Port Pin Assignments.....	90
A.1.3	Cable Diagrams.....	91

A.1 Microgrid III Interfacing Hardware

A.1.1 RS-232 Hardware Interface

The Microgrid III's interfacing hardware complies with the EIA (Electronic Industries Association) RS-232-C standard. The interface is bi-directional, asynchronous, and serial. It is capable of communicating in full duplex and uses the ASCII seven-bit data code.

The Microgrid III has two RS-232-C ports, labelled on the controller as DTE and DCE. The DTE port is configured as Data Terminal Equipment. The DCE port is configured as Data Communications Equipment. The Microgrid III issues reports and accepts commands through both ports.

A.1.2 RS-232-C Port Pin Assignments

The pin assignments for the DTE and DCE ports appear below.

RS-232-C DTE Pin Assignments (Serial Port A)

Pin	Wire Name	Transmission Flow	Description
1	shield		protective, frame ground
2	TXD	Microgrid III >>>host	transmits data from Microgrid III to host
3	RXD	Microgrid III <<<host	Microgrid III receives data from host
4	RTS	Microgrid III>>>host	Request to Send
5	CTS	Microgrid III<<<host	Clear to Send
6	DSR	Microgrid III<<<host	Data Set Ready
7	signal ground		return for serial data
20	DTR	Microgrid III>>>host	Data Terminal Ready

RS-232-C DCE Pin Assignments (Serial Port B)

Pin	Wire Name	Transmission Flow	Description
1	shield		protective, frame ground
2	RXD	Microgrid III <<<host	Microgrid III receives data from host
3	TXD	Microgrid III >>>host	Transmits data from Microgrid III to host
4	RTS	Microgrid III>>>host	Request to Send
5	CTS	Microgrid III<<<host	Clear to Send
6	DSR	Microgrid III<<<host	Data Set Ready
7	signal ground		return for serial data
20	DTR	Microgrid III>>>host	Data Terminal Ready

A.1 Microgrid III Interfacing Hardware

A.1.3 Cable Diagrams

Below are cable diagrams for the Microgrid III cables: Microgrid III PC cable and 9-pin-to-25-pin AT adapter cable.

Microgrid III PC Cable - - Use between Microgrid III Serial Port A and your PC serial port.

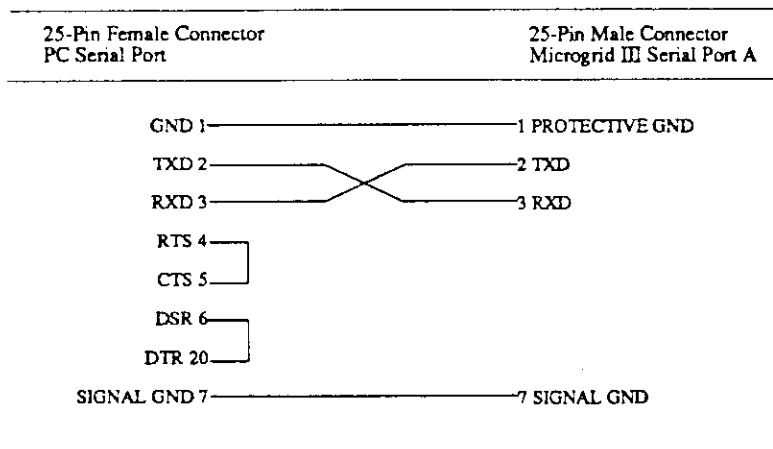

9-pin-to-25-pin AT Adapter Cable - - Converts an AT serial port to a PC serial port.

9-Pin Female Connector	25-Pin Male Connector
1	8
2	3
3	2
4	20
5	7
6	6
7	4
8	5
9	22

Appendix B

Microgrid III DIP Switch Settings

B.1 Microgrid III DIP Switch Table.....	94
B.2 Microgrid III vs Microgrid II Switch Settings.....	97

B.1 Microgrid III DIP Switch Table

Microgrid III DIP Switch # 1

Operating Characteristics and Parameters	Factory Setting	Switches and Settings							
		1	2	3	4	5	6	7	8
BAUD RATE									
19200		OFF	OFF	OFF	-	-	-	-	-
9600	*	ON	OFF	OFF	-	-	-	-	-
4800		OFF	ON	OFF	-	-	-	-	-
2400		ON	ON	OFF	-	-	-	-	-
1200		OFF	OFF	ON	-	-	-	-	-
600		ON	OFF	ON	-	-	-	-	-
300		OFF	ON	ON	-	-	-	-	-
150		ON	ON	ON	-	-	-	-	-
PARITY SETTING									
ODD PARITY		-	-	-	OFF	-	-	-	-
EVEN PARITY	*	-	-	-	ON	-	-	-	-
PARITY DISABLED		-	-	-	-	OFF	-	-	-
PARITY ENABLED	*	-	-	-	-	ON	-	-	-
NUMBER OF STOP BITS									
ONE STOP BIT		-	-	-	-	-	OFF	-	-
TWO STOP BITS	*	-	-	-	-	-	ON	-	-
NUMBER OF DATA BITS									
7 DATA BITS	*	-	-	-	-	-	-	OFF	-
8 DATA BITS		-	-	-	-	-	-	ON	-
REPORT FORMAT									
BINARY FORMAT	*	-	-	-	-	-	-	-	OFF
ASCII FORMAT		-	-	-	-	-	-	-	ON

B.1 Microgrid III DIP Switch Table

Microgrid III DIP Switch # 2

Operating Characteristics and Parameters	Factory Setting	Switches and Settings							
		1	2	3	4	5	6	7	8
ASCII REPORTS FORMAT									
ASCII INCHES		OFF	-	-	-	-	-	-	-
ASCII COUNTS	*	ON	-	-	-	-	-	-	-
ASCII DECIMAL POINT									
EXCLUDE	*	-	OFF	-	-	-	-	-	-
INCLUDE		-	ON	-	-	-	-	-	-
ASCII REPORT TERMINATOR									
CR LF		-	-	ON	-	-	-	-	-
CR	*	-	-	OFF	-	-	-	-	-
RESOLUTION									
ENGLISH	*	-	-	-	OFF	-	-	-	-
METRIC		-	-	-	ON	-	-	-	-
FIXED RESOLUTION									
ENGLISH									
100 LPI						OFF	OFF	-	-
200 LPI						ON	OFF	-	-
1000 LPI	*					OFF	ON	-	-
2000 LPI						ON	ON	-	-
FORMAT EMULATION									
MG UIOF	*	-	-	-	-	-	-	OFF	OFF
CALCOMP 9100		-	-	-	-	-	-	ON	OFF
GTCOL		-	-	-	-	-	-	OFF	ON

B.1 Microgrid III DIP Switch Table

Microgrid III DIP Switch # 3

Operating Characteristics and Parameters	Factory Setting	Switches and Settings							
		1	2	3	4	5	6	7	8
REPORT MODES									
PROMPT		OFF	OFF	-	-	-	-	-	-
POINT		ON	OFF	-	-	-	-	-	-
SWITCH STREAM		OFF	ON	-	-	-	-	-	-
STREAM	*	ON	ON	-	-	-	-	-	-
ECHO MODE									
DISABLED	*	-	-	OFF	-	-	-	-	-
ENABLED		-	-	ON	-	-	-	-	-
PROXIMITY TRANSMISSION									
TRANSMIT ONLY IN-PROX	*	-	-	-	OFF	-	-	-	-
ALWAYS TRANSMIT		-	-	-	ON	-	-	-	-
RESERVED									
	*	-	-	-	-	OFF	-	-	-
		-	-	-	-	-	-	-	-
DUAL TRANSDUCER									
ENABLED	*	-	-	-	-	-	OFF	-	-
DISABLED		-	-	-	-	-	ON	-	-
TRANSDUCER SELECT									
4-BUTTON CURSOR/STYLUS		-	-	-	-	-	-	OFF	-
16-BUTTON CURSOR	*	-	-	-	-	-	-	ON	-
CUSTOMIZED OPTION	*	-	-	-	-	-	-	-	OFF

B.2 Microgrid III vs Microgrid II Switch Settings

Microgrid III DIP Switch # 1

OPERATING CHARACTERISTICS AND PARAMETERS	SWITCH SETTINGS MICROGRID III			MICROGRID II		
BAUD RATE	1-1	1-2	1-3	1-1	1-2	1-3
150	ON	ON	ON	ON	ON	ON
300	OFF	ON	ON	OFF	ON	ON
600	ON	OFF	ON	ON	OFF	ON
1200	OFF	OFF	ON	OFF	OFF	ON
2400	ON	ON	OFF	ON	ON	OFF
4800	OFF	ON	OFF	OFF	ON	OFF
9600	ON	OFF	OFF	ON	OFF	OFF
19200	OFF	OFF	OFF	OFF	OFF	OFF
PARITY SETTING	1-4			1-4		
EVEN	ON			ON		
ODD	OFF			OFF		
PARITY	1-5			N/A		
ENABLED	ON					
DISABLED	OFF					
STOP BITS	1-6			1-5		
TWO	ON			ON		
ONE	OFF			OFF		
DATA BITS	1-7			N/A		
EIGHT	ON					
SEVEN	OFF					
REPORT FORMAT	1-8			2-4		
ASCII	ON			OFF		
BINARY	OFF			ON		

B.2 Microgrid III vs Microgrid II Switch Settings

Microgrid III DIP Switch # 2

OPERATING CHARACTERISTICS AND PARAMETERS	SWITCH SETTINGS MICROGRID III			MICROGRID II	
ASCII COUNTS REPORT FORMAT	2-1			N/A	
COUNTS	ON				
INCHES	OFF				
ASCII DECIMAL POINT	2-2			2-6	
INCLUDE	ON			ON	
EXCLUDE	OFF			OFF	
ASCII REPORT TERMINATOR	2-3			2-5	
CR LF	ON			ON	
CR	OFF			OFF	
RESOLUTION	2-4			N/A	
METRIC	ON				
ENGLISH	OFF				
FIXED RESOLUTION					
ENGLISH METRIC	2-5	2-6			
100 LPI 4 LPMM	OFF	OFF	200 LPI	2-1	2-2
200 LPI 10 LPMM	ON	OFF	10 LPMM	OFF	OFF
1000 LPI 40 LPMM	OFF	ON	1000 LPI	ON	OFF
2000 LPI 80 LPMM	OFF	ON	40 LPMM	OFF	ON
EMULATION	2-7			2-8	
UIOF	OFF			OFF	
CALCOMP	ON			OFF	
GTCO	OFF			ON	

B.2 Microgrid III vs Microgrid II Switch Settings

Microgrid III DIP Switch # 3

OPERATING CHARACTERISTICS AND PARAMETERS	SWITCH SETTINGS MICROGRID III		MICROGRID II	
REPORT COLLECTION MODE	3-1	3-2	2-7	2-8
PROMPT MODE	OFF	OFF	OFF	OFF
POINT MODE	ON	OFF	OFF	ON
SWITCH STREAM MODE	OFF	ON	ON	OFF
STREAM MODE	ON	ON	ON	ON
ECHO	3-3		1-6	
ON	ON		ON	
OFF	OFF		OFF	
PROXIMITY TRANSMISSION	3-4		1-7	
ALWAYS TRANSMIT	ON		ON	
ONLY IN-PROX	OFF		OFF	
MARGIN TRANSMISSION	3-5		N/A	
ACTIVE AREA AND MARGIN	ON			
ACTIVE AREA ONLY	OFF			
DUAL TRANSDUCER	3-6		N/A	
AUTO	ON			
SELECT	OFF			
TRANSDUCER SELECT	3-7		N/A	
CURSOR (16-BUTTON)	ON			
STYLUS (4-BUTTON CURSOR/STYLUS)	OFF			
CUSTOMIZED OPTION	3-8		N/A	
	OFF			
GRID DIAGNOSTICS	N/A		1-8	
PROMPTS TO HOST			ON	
NO PROMPTS TO HOST			OFF	

Appendix C

Microgrid III Specifications

Appendix C Microgrid III Specifications

Physical Specifications

Tablet Size (Footprint)	Active Area Size	Weight (Tablet and Controller)
26" x 32.5"	17" x 24"	22 lbs.
32.5" x 26"	24" x 17"	22 lbs.
29" x 29"	20" x 20"	21.5 lbs.
32.5" x 44.5"	24" x 36"	37.5 lbs.
44.5" x 56"	36" x 48"	62.25 lbs.
51.35" x 68.38"	44" x 60"	90 lbs.

Performance Specifications

Technology:	Electromagnetic
Resolution:	up to 2000 lines per inch
Standard Accuracy:	+/- .005 (standard), +/- .002 (optional)
Proximity:	up to 0.5" (12.7 mm)
Format:	Microgrid (Universal Input Output Format) Calcomp 9100 Series format GTCO 5A Series format MM (SummaSketch) format
Baud Rate:	150- 19,200
Data Rate:	Up to 159 reports per second
Jitter:	Cursor; +/-1 count per second Stylus; +/-2 count per second
Repeatability:	+/-0.002" or better
Cursor Eccentricity:	+/- .004" or better
Interface:	RS-232-C 25-pin D female connector for PC, PS/2, XT and compatibles
Power Requirements:	12 VAC, 1 amp
Certification:	UL, CSA, FCC Class B, TUV/VDE and tested for ESD

Appendix C Microgrid III Specifications

Environmental Specifications

Operating Environment: +45 degrees to + 100 degrees Fahrenheit
+7 degrees to +43 degrees Celsius
8% to 80% relative humidity, non-condensing

Non-Operating: -45 degrees to + 145 degrees Fahrenheit
-43 degrees to +63 degrees Celsius
8% to 80% relative humidity, non-condensing

Appendix D

GTCO Format Emulation

The Microgrid III can emulate the GTCO output format. This chapter provides the binary and ASCII information for the GTCO output format.

D.1	GTCO Output Format.....	106
D.1.1	Overview	106
D.1.2	ASCII BCD Report Format.....	106
D.1.3	Packed Binary Report Format	108
D.1.4	GTCO DIP Switch Settings.....	110

D.1 GTCO Output Format

D.1.1 Overview

The Microgrid III report formats conform to GTCO 5A standards. To accommodate your emulation needs, you can choose the GTCO format to be in ASCII or packed binary.

D.1.2 ASCII BCD Report Format

Within the ASCII BCD report format you can choose:

- the output to be in counts, inches or millimeters.
In units of measure (inches or millimeters), you can also choose the format to include a decimal or not. This does not change the value of the coordinate. For example, 10.123 inches can be reported as either 10123 or 10.123.
- each report to terminate with a <CR><LF> or just a <CR>.
- the delimiter to be any ASCII character. (The default is a comma.)

Refer to the key for definitions of the format characters.

For reports, low resolution is:

```
FXXXXSYYYY<CR><LF>
```

For reports, high resolution is:

```
FXXXXSYYYYY<CR><LF>
```

D.1 GTCO Output Format

Key

Character	Definition
S	space (optional)
X	a digit of the X coordinate, where each digit is an ASCII character, 0 through 9
,	the delimiter character. The default is an ASCII comma.
Y	a digit of the Y coordinate, where each digit is an ASCII character, 0 through 9
F	flag character, identifying the transducer buttons being pressed. The possible combinations are listed in the table below.

3-Button Stylus Buttons	2-Button Stylus Buttons	4-button Cursor Buttons	16-button Cursor Buttons	ASCII Output
none	none	none	none	0
tip	tip	0	1	0
first barrel	barrel	1	2	1
second barrel	tip and barrel	2	3	2
---	---	---	C	3
---	---	3	4	4
---	---	---	5	5
---	---	---	6	6
---	---	---	D	7
---	---	4	7	8
---	---	---	8	9
---	---	---	9	:
---	---	---	E	:
---	---	---	A	<
---	---	---	0	=
---	---	---	B	>
---	---	---	F	?

Note: The cursors are designed for single, not multiple, button use. Pressing multiple buttons simultaneously yields unpredictable results.

<CR>	ASCII carriage return
<LF>	ASCII line feed

D.1 GTCO Output Format

D.1.3 Packed Binary Report Format

The Microgrid III can emulate two kinds of GTCO binary formats: low resolution and high resolution.

Low Resolution Binary

Stop Bits	MSB	7	6	5	4	3	2	1	LSB	0	Start Bit	Transmission Sequence
SB	P	PH	PB4	PB3	PB2	PB1	PB5	0	0	0	0	1st byte
SB	P	0	X5	X4	X3	X2	X1	X0	0	0	0	2nd byte
SB	P	0	X11	X10	X9	X8	X7	X6	0	0	0	3rd byte
SB	P	0	Y5	Y4	Y3	Y2	Y1	Y0	0	0	0	4th byte
SB	P	0	Y11	Y10	Y9	Y8	Y7	Y6	0	0	0	5th byte

High Resolution Binary

Stop Bits	MSB	7	6	5	4	3	2	1	LSB	0	Start Bit	Transmission Sequence
SB	PH	PB5	PB4	PB3	PB2	PB1	X15	X14	0	0	0	1st byte
SB	0	X13	X12	X11	X10	X9	X8	X7	0	0	0	2nd byte
SB	0	X7	X6	X5	X4	X3	X2	X1	0	0	0	3rd byte
SB	0	0	0	0	0	0	Y15	Y14	0	0	0	4th byte
SB	0	Y13	Y12	Y11	Y10	Y9	Y8	Y7	0	0	0	5th byte
SB	0	Y6	Y5	Y4	Y3	Y2	Y1	Y0	0	0	0	6th byte

Refer to the key for definitions of the format characters.

D.1 GTCO Output Format

Key

Character	Definition
LSB	least significant bit
MSB	most significant bit
PH	phasing bit, set for 1
SB	one or two stop bits
PB1-PB5	flag bit, identifying the transducer buttons being pressed. The possible combinations are listed in the tables below.

Flag Bit Definitions For The 16-Button Cursor

16-button Cursor Buttons	Binary Output				
	PB4	PB3	PB2	PB1	PB5
none	0	0	0	0	0
1	0	0	0	0	1
2	0	0	0	1	1
3	0	0	1	0	1
C	0	0	1	1	1
4	0	1	0	0	1
5	0	1	0	1	1
6	0	1	1	0	1
D	0	1	1	1	1
7	1	0	0	0	1
8	1	0	0	1	1
9	1	0	1	0	1
E	1	0	1	1	1
A	1	1	0	0	1
0	1	1	0	1	1
B	1	1	1	0	1
F	1	1	1	1	1

Flag Bit Definitions For the Two-Button Stylus and Four-Button Cursor

3-Button Stylus Buttons	2-Button Stylus Buttons	4-Button Cursor Buttons	Binary Output				
			PB4	PB3	PB2	PB1	PB5
none	none	none	0	0	0	0	0
tip	tip	1	0	0	0	1	0
first barrel	barrel	2	0	0	1	0	0
second barrel	---	3	0	1	0	0	0
---	---	4	1	0	0	0	0

D.1 GTCO Output Format

D.1.4 GTCO DIP Switch Settings

When configuring your Microgrid III in the GTCO format, the DIP switches perform the same functions except for the following:

Command Name	Switch Settings - - Dip Switch #2		
	2-1	2-2	2-3
Carriage Return	ON	-	-
No Carriage Return	OFF	-	-
Space	-	ON	-
No Space	-	OFF	-
Line Feed	-	-	ON
No Line Feed	-	-	OFF

Appendix E

Calcomp Format Emulation

The Microgrid III can emulate the Calcomp output format. This chapter provides the binary and ASCII information for the Calcomp output format.

E.1	Calcomp Output Format.....	112
E.1.1	Overview.....	112
E.1.2	ASCII BCD Report Formats.....	112
E.1.3	Packed Binary Report Format.....	114
E.1.4	Calcomp DIP Switch Settings.....	116

E.1 Calcomp Output Format

E.1.1 Overview

The Microgrid III report formats conform to Calcomp standards. To accommodate your emulation needs, you may choose from one of four ASCII formats, or a packed binary format.

E.1.2 ASCII BCD Report Formats

Within the ASCII BCD report formats you may choose:

- the output to be in counts, inches or millimeters.
In units of measure (inches or millimeters), you can also choose the format to include a decimal or not. This does not change the value of the coordinate. For example, 10.123 inches can be reported as either 10123 or 10.123.
- each report to terminate with a <CR><LF> or just a <CR>.
- the delimiter to be any ASCII character. (The default is a comma.)

Refer to the key for definitions of the format characters.

Format 1 (1000 LPI, 40 LPMM)

```
<T><M><C>XXXXXXYYYYY<CR>  
2000 lpi  
<T><M><C>XXXXXXYYYYY<CR>
```

Format 2 (1000 LPI, 40 LPMM)

```
XXXXX, YYYYY, <T><M><C><CR>  
2000 lpi  
XXXXXX, YYYYYY, <T><M><C><CR>
```

Format 3 (1000 LPI, 40 LPMM)

```
<C><P>XXXXXXYYYYY<CR>  
2000 lpi  
<C><P>XXXXXXYYYYY<CR>
```

Format 4

```
1000 LPI  
    <SP>XX.XXX, <SP>YY.YYY, <T><M><C><CR>  
40 LPMM  
    <SP>XXXXX., <SP>YYYYY., <T><M><C><CR>
```

E.1 Calcomp Output Format

Key

Character	Definition																									
T	tablet status character																									
M	mode status character																									
	R = run U = line P = point T = track I = increment																									
P	pen (cursor) status																									
	U = pen up D = pen down																									
X	a digit of the X coordinate, where each digit is an ASCII character, 0 through 9																									
.	the delimiter character. The default is an ASCII comma.																									
Y	a digit of the Y coordinate, where each digit is an ASCII character, 0 through 9																									
C	cursor flag character, identifying the transducer buttons being pressed. The possible combinations are listed in the table below. U = no flags depressed.																									
	<table border="1"> <thead> <tr> <th>3-Button Stylus Buttons</th> <th>2-Button Stylus Buttons</th> <th>4-button Cursor Buttons</th> <th>16-button Cursor Buttons</th> <th>ASCII Output</th> </tr> </thead> <tbody> <tr> <td>none</td> <td>none</td> <td>none</td> <td>none</td> <td>U</td> </tr> <tr> <td>tip</td> <td>tip</td> <td>1</td> <td>1</td> <td>0</td> </tr> <tr> <td>first barrel</td> <td>barrel</td> <td>2</td> <td>2</td> <td>1</td> </tr> <tr> <td>second barrel</td> <td>tip and barrel</td> <td>3</td> <td>3</td> <td>2</td> </tr> </tbody> </table>	3-Button Stylus Buttons	2-Button Stylus Buttons	4-button Cursor Buttons	16-button Cursor Buttons	ASCII Output	none	none	none	none	U	tip	tip	1	1	0	first barrel	barrel	2	2	1	second barrel	tip and barrel	3	3	2
3-Button Stylus Buttons	2-Button Stylus Buttons	4-button Cursor Buttons	16-button Cursor Buttons	ASCII Output																						
none	none	none	none	U																						
tip	tip	1	1	0																						
first barrel	barrel	2	2	1																						
second barrel	tip and barrel	3	3	2																						
	Note: The cursors are designed for single, not multiple, button use. Pressing multiple buttons simultaneously yields unpredictable results.																									
<CR>	ASCII carriage return																									
<LF>	ASCII line feed																									

E.1 Calcomp Output Format

E.1.3 Packed Binary Report Format

The Microgrid III can emulate two types of Calcomp binary formats: low resolution and high resolution.

Low Resolution Binary

		7	6	5	4	3	2	1	0
BYTE 1	P	1	C3	C2	C1	C0	0	0	
BYTE 2	P	0	X5	X4	X3	X2	X1	X0	
BYTE 3	P	0	X11	X10	X9	X8	X7	X6	
BYTE 4	P	0	Y5	Y4	Y3	Y2	Y1	Y0	
BYTE 5	P	0	Y11	Y10	Y9	Y8	Y7	Y6	

High Resolution Binary

		8	7	6	5	4	3	2	1	0
BYTE 1	P	1	C4	C3	C2	C1	C0	X15	X14	
BYTE 2	P	0	X13	X12	X11	X10	X9	X8	X7	
BYTE 3	P	0	X6	X5	X4	X3	X2	X1	X0	
BYTE 4	P	0	0	0	0	X16	Y16	Y15	Y14	
BYTE 5	P	0	Y13	Y12	Y11	Y10	Y9	Y8	Y7	
BYTE 6	P	0	Y6	Y5	Y4	Y3	Y2	Y1	Y0	

Refer to the key for definitions of the format characters.

E.1 Calcomp Output Format

Key

Character	Definition
LSB	least significant bit
MSB	most significant bit
P	parity bit
C0-C4	flag bit, identifying the transducer buttons being pressed. The Possible combinations are listed in the tables below.

Flag Bit Definitions For The 16-Button Cursor

16-button Cursor Buttons	Binary Output				
	C4	C3	C2	C1	C0
none	0	0	0	0	0
1	1	0	0	0	0
2	1	0	0	0	1
3	1	0	0	1	0
C	1	0	0	1	1
4	1	0	1	0	0
5	1	0	1	0	1
6	1	0	1	1	0
D	1	0	1	1	1
7	1	1	0	0	0
8	1	1	0	0	1
9	1	1	0	1	0
E	1	1	0	1	1
A	1	1	1	0	0
0	1	1	1	0	1
B	1	1	1	1	0
F	1	1	1	1	1

Flag Bit Definitions For the Two-Button Stylus and Four-Button Cursor

3-Button Stylus Buttons	2-Button Stylus Buttons	4-Button Cursor Buttons	Binary Output				
			C4	C3	C2	C1	C0
none	none	none	0	0	0	0	0
tip	tip	1	0	0	0	0	1
first barrel	barrel	2	0	0	0	1	0
second barrel	---	3	0	0	1	0	0
---	---	4	0	1	0	0	0

E.1 Calcomp Output Format

E.1.4 Calcomp DIP Switch Settings

When configuring your Microgrid III in the Calcomp format, the DIP switches perform the same functions except for the following:

Command Name	Switch Settings - - Dip Switch #2			
	2-1	2-2	2-7	2-8
CalComp 9100 ASCII Format				
1	OFF	OFF	ON	OFF
2	ON	OFF	ON	OFF
3	OFF	ON	ON	OFF
4	ON	ON	ON	OFF
	2-5	2-6	2-7	2-8
CalComp 9100 Binary Format				
200 lpi	OFF	OFF	ON	OFF
1000 lpi (40 lpmm)	OFF	ON	ON	OFF
2000 lpi (80 lpmm)	ON	ON	ON	OFF

Appendix F

MM/SummaSketch Format Emulation

The Microgrid III can emulate the Summagraphics MM/SummaSketch output format. This chapter provides the binary and ASCII information for the MM/SummaSketch output format.

F.1	MM/SummaSketch Output Format.....	118
F.1.1	Overview.....	118
F.1.2	Binary Report Format.....	118
F.1.3	ASCII BCD Report Format.....	120
F.1.4	MM/SummaSketch Command Summary.....	121
F.1.5	MM/SummaSketch Switch Settings.....	122

F.1 MM/SummaSketch Output Format

F.1.1 Overview

The Microgrid III report formats conform to MM/SummaSketch standards. To accommodate your emulation needs, you may choose either a binary or an ASCII BCD format. The reports are in counts of resolution.

Note: When configuring the Summagraphics LCL for the default 500 lpi resolution in binary format, the active area size will be limited to 16.383 inches. If you wish to utilize the entire active area, you must set the fixed resolution to 200 lpi.

F.1.2 Binary Report Format

Binary Format For Absolute Coordinates

Transmission Sequence	MSB							LSB
	7	6	5	4	3	2	1	0
BYTE 1	PH	PR	T	Sx	Sy	Fc	Fb	Fa
BYTE 2	0	X6	X5	X4	X3	X2	X1	X0
BYTE 3	0	X13	X12	X11	X10	X9	X8	X7
BYTE 4	0	Y6	Y5	Y4	Y3	Y2	Y1	Y0
BYTE 5	0	Y13	Y12	Y11	Y10	Y9	Y8	Y7

Binary Format For Relative Coordinates

Transmission Sequence	MSB							LSB
	7	6	5	4	3	2	1	0
BYTE 1	PH	PR	T	Sx	Sy	Fc	Fb	Fb
BYTE 2	0	X6	X5	X4	X3	X2	X1	X0
BYTE 3	0	Y6	Y5	Y4	Y3	Y2	Y1	Y0

Refer to the key for definitions of the format characters.

F.1 MM/SummaSketch Output Format

Key

Character	Definition
LSB	least significant bit
MSB	most significant bit
Fa - Fc	flag bits, identifying the stylus/cursor buttons being pressed. The possible combinations are listed in the tables below.

Flag Bit Definitions For The Stylus And Four-Button Cursor

Stylus Buttons	Cursor Buttons	Fc	Fb	Fa
none pressed	none pressed	0	0	0
tip button pressed	1 pressed	0	0	1
barrel button pressed	2 pressed	0	1	0
tip and barrel pressed	3 pressed	0	1	1
	4 pressed	1	0	0
	1+2	0	1	1
	1+3	1	0	0
	1+4	1	0	1
	2+3	1	0	1
	2+4	1	1	0
	3+4	1	1	1
	1+2+3	1	1	0
	1+2+4	1	1	1
	1+3+4	1	1	1
	2+3+4	1	1	1
	1+2+3+4	1	1	1

Sx and Sy the X and Y coordinate signs. 1 is positive. 0 is negative. In absolute coordinates, the sign is always positive. In relative coordinates, the sign can be positive or negative.

T tablet identifier. Your choice of 1 or 0. Command controlled.

PR proximity bit. 0 is in-prox. 1 is out-of-prox.

PH phasing bit, which is always 1.

X0, X1... X coordinate bits.

Y0, Y1... Y coordinate bits.

F.1 MM/SummaSketch Output Format

F.1.3 ASCII BCD Report Format

The ASCII BCD format depends on the coordinate system and resolution:

Resolution	Format
1 to 508 lpi (20 lpmm)	XXXX,YYYY,F<CR><LF>
1000 lpi (40 lpmm)	XXXXX,YYYYY,F<CR><LF>

Key

Character	Definition
X	X coordinate digit, where each digit is an ASCII character from 0 to 9.
,	ASCII comma
Y	Y coordinate digit, where each digit is an ASCII character from 0 to 9.
F	the stylus and cursor flag character, identifying the button status:

Flag Bit Definitions For The Stylus And Four-Button Cursor

Stylus Buttons	Cursor Buttons	F
none pressed	none pressed	0
tip button pressed	1 pressed	1
barrel button pressed	2 pressed	2
tip and barrel pressed	3 pressed	3
	4 pressed	4
	1+2	3
	1+3	4
	1+4	5
	2+3	5
	2+4	6
	3+4	7
	1+2+3	6
	1+2+4	7
	1+3+4	7
	2+3+4	7
	1+2+3+4	7

<CR> ASCII carriage return character.

<LF> ASCII line feed character.

F.1 MM/SummaSketch Output Format

F.1.4 MM/SummaSketch Command Summary

Command	ASCII	Command	ASCII
Axis Update Mode: command	G	Resolution: 1 lpi	l
value	<SP> to 	2 lpi	n
		4 lpi	p
Coordinate System:		100 lpi	d
absolute	F	200 lpi	e
relative	E	10 lpmm	f
		400 lpi	g
Echo	k	500 lpi	h
		20 lpmm	i
Increment Mode:		1000 lpi	j
command	I	40 lpmm	q
increment value	<SP> to 	Resume Transmission	<CTRL>Q
Origin:		Send Model ID	<ENQ>
upper left	b	Send Test Results	w
lower left	c	Stop Transmission	<CTRL>S
Report Modes:		Tablet Identifier:	
Point Mode	B	zero	0
Remote Request Mode:		one	1
mode command	D	Z commands:	
trigger command	P	binary report format	zb
Stream Mode	@	8 data bits, no parity	z8
Switch Stream Mode	A	8 data bits, odd parity	z9
		increment confirmation	zi
		firmware identification	z?
		transducer identification	zt
		additional filter	zf
		16-button cursor enable	z6
Report Rate:			
90 rps	Q		
73 rps	R		
22 rps	S		
5.75 rps	T		
Reset	<NUL>		
Resolution Definable:			
command	r		
X axis resol., low byte	Hex 00 to FF		
X axis resol., high byte	Hex 00 to 17		
Y axis resol., low byte	Hex 00 to FF		
Y axis resol., high byte	Hex 00 to 17		

F.1 MM/SummaSketch Output Format

F.1.5 MM/SummaSketch DIP Switch Settings

When configuring your Microgrid III in the MM/SummaSketch format, the DIP switches perform the same functions *except* in the following situation:

When the tablet is placed in MM binary format, it defaults to 8 data bits, regardless of how DIP switch A-7 (switch bank A, position 7) is set.

Refer to Appendix B for a complete listing of Microgrid III Dip switch settings.

Appendix G ASCII Conversion Chart

Appendix G ASCII Conversion Chart

Decimal	Binary 7 6 5 4 3 2 1 0	Octal	Hex	ASCII Character	Control Function or Character Description
0	00000000	000	00	NUL	Null
1	00000001	001	01	SOH	Start of Heading
2	00000010	002	02	STX	Start of Text
3	00000011	003	03	ETX	End of Text
4	00000100	004	04	EOT	End of Transmission
5	00000101	005	05	ENQ	Enquiry
6	00000110	006	06	ACK	Acknowledge
7	00000111	007	07	BEL	Bell
8	00001000	010	08	BS	Backspace
9	00001001	011	09	HT	Horizontal Tab
10	00001010	012	0A	LF or NL	Line Feed or New Line
11	00001011	013	0B	VT	Vertical Tab
12	00001100	014	0C	FF	Form Feed
13	00001101	015	0D	CR or RT	Carriage Return
14	00001110	016	0E	SO	Shift Out
15	00001111	017	0F	SI	Shift In
16	00010000	020	10	DLE	Data Link Escape
17	00010001	021	11	DC1	Device Control 1
18	00010010	022	12	DC2	Device Control 2
19	00010011	023	13	DC3	Device Control 3
20	00010100	024	14	DC4	Device Control 4
21	00010101	025	15	NAK	Negative Acknowledge
22	00010110	026	16	SYN	Synchronous Idle
23	00010111	027	17	ETB	End Transmission Block
24	00011000	030	18	CAN	Cancel
25	00011001	031	19	EM	End of Medium
26	00011010	032	1A	SUB	Substitute
27	00011011	033	1B	ESC	Escape
28	00011100	034	1C	FS	File Separator
29	00011101	035	1D	GS	Group Separator
30	00011110	036	1E	RS	Record Separator
31	00011111	037	1F	US	Unit Separator
32	00100000	040	20	SP	Space
33	00100001	041	21	!	Exclamation Point
34	00100010	042	22	"	Double Quote
35	00100011	043	23	#	Number or Pound
36	00100100	044	24	\$	Dollar
37	00100101	045	25	%	Percent
38	00100110	046	26	&	Ampersand
39	00100111	047	27	'	Apostrophe
40	00101000	050	28	(Left Parenthesis
41	00101001	051	29)	Right Parenthesis
42	00101010	052	2A	*	Asterisk
43	00101011	053	2B	+	Plus or Addition

Appendix G ASCII Conversion Chart

cont.

Decimal	Binary 7 6 5 4 3 2 1 0	Octal	Hex	ASCII Character	Control Function or Character Description
44	00101100	054	2C	,	Comma
45	00101101	055	2D	-	Hyphen
46	00101110	056	2E	.	Period
47	00101111	057	2F	/	Slash
48	00110000	060	30	0	
49	00110001	061	31	1	
50	00110010	062	32	2	
51	00110011	063	33	3	
52	00110100	064	34	4	
53	00110101	065	35	5	
54	00110110	066	36	6	
55	00110111	067	37	7	
56	00111000	070	38	8	
57	00111001	071	39	9	
58	00111010	072	3A	:	Colon
59	00111011	073	3B	;	Semicolon
60	00111100	074	3C	<	Less Than
61	00111101	075	3D	=	Equals
62	00111110	076	3E	>	Greater Than
63	00111111	077	3F	?	Question Mark
64	01000000	100	40	@	Commercial At
65	01000001	101	41	A	
66	01000010	102	42	B	
67	01000011	103	43	C	
68	01000100	104	44	D	
69	01000101	105	45	E	
70	01000110	106	46	F	
71	01000111	107	47	G	
72	01001000	110	48	H	
73	01001001	111	49	I	
74	01001010	112	4A	J	
75	01001011	113	4B	K	
76	01001100	114	4C	L	
77	01001101	115	4D	M	
78	01001110	116	4E	N	
79	01001111	117	4F	O	
80	01010000	120	50	P	
81	01010001	121	51	Q	
82	01010010	122	52	R	
83	01010011	123	53	S	
84	01010100	124	54	T	
85	01010101	125	55	U	
86	01010110	126	56	V	
87	01010111	127	57	W	
88	01011000	130	58	X	
89	01011001	131	59	Y	

Appendix G ASCII Conversion Chart

cont.

Decimal	Binary 7 6 5 4 3 2 1 0	Octal	Hex	ASCII Character	Control Function or Character Description
90	01011010	132	5A	Z	
91	01011011	133	5B	[Left Square Bracket
92	01011100	134	5C	\	Back Slash
93	01011101	135	5D]	Right Square Bracket
94	01011110	136	5E	^	Circumflex
95	01011111	137	5F	_	Underscore
96	01100000	140	60	`	Left Single Quote
97	01100001	141	61	a	
98	01100010	142	62	b	
99	01100011	143	63	c	
100	01100100	144	64	d	
101	01100101	145	65	e	
102	01100110	146	66	f	
103	01100111	147	67	g	
104	01101000	150	68	h	
105	01101001	151	69	i	
106	01101010	152	6A	j	
107	01101011	153	6B	k	
108	01101100	154	6C	l	
109	01101101	155	6D	m	
110	01101110	156	6E	n	
111	01101111	157	6F	o	
112	01110000	160	70	p	
113	01110001	161	71	q	
114	01110010	162	72	r	
115	01110011	163	73	s	
116	01110100	164	74	t	
117	01110101	165	75	u	
118	01110110	166	76	v	
119	01110111	167	77	w	
120	01111000	170	78	x	
121	01111001	171	79	y	
122	01111010	172	7A	z	
123	01111011	173	7B	{	Left Curved Bracket
124	01111100	174	7C		Vertical Line
125	01111101	175	7D	}	Right Curved Bracket
126	01111110	176	7E	~	Tilde
127	01111111	177	7F	DEL	Delete (rubout)

Appendix H

Microgrid III Application Set Up

This appendix provides DIP switch settings for the popular software applications. Use this chart as a quick reference; for more detailed information please refer to the tablet installation procedures in your application's manual.

Note: The information provided in this chapter was supplied by the software manufacturers and may not have been tested by Sunmagraphics. We assume no responsibility for the accuracy of the information. Should you find any errors, please let us know so we can update our manual in future releases.

Appendix H Microgrid III Application Set Up

Application	Switch 1	Switch 2	Switch 3	Emulation
Advance Estimating Tools	10000011	00110101	10000100	GTCO
Area Works	10000101	10100100	10000110	Microgrid
ARRIS	10001001	10100100	00000110	Microgrid
ATEC CAD/CAM	10011101	11100000	11010110	Microgrid
Atlas Draw	10011100	11100100	11000110	Microgrid
AutoCAD-DOS *	10011100	00100100	11000110	Microgrid
Cadkey	10011100	00100100	11000110	Microgrid
CasCAD I, II, III	10011100	11100100	11000110	Microgrid
CEAL	10011000	11100100	11000110	Microgrid
CivilCAD	10011100	00100100	11000110	Microgrid
CO-GO PC Plus	10011101	01100100	11000110	Microgrid
Com Quest	11011101	10100100	10000100	Microgrid
Construction Estimator	10001101	10100101	10000100	GTCO
Contour Plus	10011101	01100100	11000110	Microgrid
CPS/PC *	10011100	00100100	11000110	Microgrid
Digi Plus	10011101	01100100	11000110	Microgrid
Digitizing Quantitative	10000011	11100101	10100110	GTCO
DTM 386	10011101	01100100	00010110	Microgrid
Earthwork II and II C	10000101	10100100	10000110	Microgrid
Easy CAD 2	10011100	10100100	11000110	Microgrid
Easy DIJ	10011101	11100100	11100110	Microgrid
ESP 386	10011101	01100100	00010110	Microgrid
Estimagic	00101001	11100101	10100110	GTCO
FastCAD	10011100	10100100	11000110	Microgrid
Galaxy	10011100	10100100	01000110	Microgrid
Generic CADD	10011100	01100100	11000110	Microgrid
GM-SYS	10011100	01100100	11000110	Microgrid
HDS LOG Analysis	10011100	10100000	10000110	Microgrid
Hotdij	10011101	11100100	11100110	Microgrid
Illustrator 1	10011001	11100100	00010110	Microgrid
INFOCAD	10011100	00100100	11010110	Microgrid

* *Factory Setting*

Appendix H Microgrid III Application Set Up

Application	Switch 1	Switch 2	Switch 3	Emulation
InterCAD 2040	10011001	01100100	00010110	Microgrid
Job Boss	00111001	10000101	10101110	GTCO
Land Trak	11001001	01100100	11000110	Microgrid
LogDigi	10011100	01100100	11000110	Microgrid
MAPDTM	10011101	10100100	11000110	Microgrid
MAPEDT	10011101	10100100	11000110	Microgrid
MAPOVL	10011101	10100100	11000110	Microgrid
MAPROC	10011101	10100100	11000110	Microgrid
Marvin Windows	10011100	00100100	11000110	Microgrid
Mech. Const. Mgr.	10000011	10110101	10000110	GTCO
MegaMODEL *	10011100	00100100	11000110	Microgrid
MetaSite	10011100	01000100	00000110	Microgrid
MicroStation	10011100	01100100	11000110	Microgrid
NeoVisuals	10011000	10100100	00010110	Microgrid
pcARC/INFO	10011000	00100100	01100110	Microgrid
Pella Designer *	10011100	00100100	11000110	Microgrid
PEPS *	10011100	00100100	11000110	Microgrid
Piping/DWV Estimating	10011100	00001100	01000110	Microgrid
Precision Digitizer	11000011	11100101	10000110	GTCO
Precision Estimating	11000011	11100101	10000110	GTCO
Profit Bid Estimating	00101100	00000100	01000110	Microgrid
QuicKEST	10011100	00000101	01000110	Microgrid
Quickpen Estimating	00111001	11000101	10000110	GTCO
QuickSurf *	10011100	00100100	11000110	Microgrid
RAMCO Estimating Prog.	10000011	10000101	11000110	GTCO
SDP	10011101	01100100	11000110	Microgrid
SmartCAM	10011101	00000100	00000110	Microgrid
The Edge	10000010	01000101	11000100	GTCO
The Mc ² ICE Sys.	10011101	11100101	10000110	GTCO
The Remodeling Est. Plus	10000010	10100101	11000100	GTCO
VersaCAD *	10011100	00100100	11000110	Microgrid

* *Factory Setting*

Index

- absolute coordinates 16
- active area 16
- ADB ports 9
- application set up 127-129
- ASCII report format 56, 57
- ASCII conversion chart 123-126
- AT adapter cable 4, 10, 91
- Autodesk application driver 23-26

- baud rate 54

- Calcomp format emulation 75, 111-116
- change emulation command 53
- cleaning the Microgrid 46
- commands
 - change emulation 53
 - communication protocol 54
 - data format commands 56
 - LED control 69
 - proximity transmission 64
 - relocate origin 70
 - report modes: increment 63
 - report modes: point 60
 - report modes: prompt 59
 - report modes: set report rate 62
 - report modes: stream and switch stream 61
 - resolution commands: confirm 73
 - resolution commands: fixed 71
 - resolution commands: variable 72
 - see-thru 67
 - select transducer 66
 - skew correction 74
 - sound annunciator 68
 - transmission control 65
- communications protocol 54, 55
 - baud rate 54
 - data bits 55
 - parity 55
 - stop bits 55
- controller 4, 8-13
- cursor 4, 5, 8-10, 13, 18, 19
 - 16-button 18, 19
 - 4-button 18
 - caring for 46
- cursor holder 4, 13
- confirm resolution command 73

- data bits 55
- data formats 56, 57
 - ASCII 56, 57
 - binary 56, 57
- data format commands 56, 57
- DGMG.COM 23-26

- diagnostics 47, 37-44
- dip switch settings 12, 93-99
- dos prompt vs batch files 22
- drivers 21-36
- driver flowcharts 81-86

- environmental specifications 101

- fixed resolution 17, 71

- GTCO format emulation 53, 105-110

- increment mode 63
- installation 7-13
- installing the tablet 7-13
- interfacing hardware 89
 - RS-232 90
 - cable diagrams 91

- LED control command 69

- maintenance 46
- margin area 16
- MG3TEST 37-40
- Microgrid II dip switch settings 97-99
- Microsoft Windows driver 31-36
- MM/SummaSketch format emulation 75, 117-122
- multiple pointing devices 19

- output formats 53
 - Calcomp 53, 110-116
 - GTCO 53, 105-110
 - MM/SummaSketch 53, 75, 117-122
 - UIOF 53, 75-80

- parity 54
- PC cable 4, 5, 8, 10, 90
- performance specifications 102
- physical specifications 102
- pointing device 16, 18, 19
- point mode 60
- power input port 9, 11
- power supply 4, 5, 8, 11
- power up 13
- power up diagnostics 47
- prompt mode 59
- proximity 16
- proximity transmission

- command 64
- relocate origin command 70
- report 16
- report modes
 - increment 63
 - point 60
 - prompt 59
 - set report rate 62
 - stream and switch stream 61
- resolution 17
- resolution commands
 - confirm 73
 - fixed 71
 - variable 72

- see -thru command 67
- select transducer command 66
- SEND.COM 42, 43
- serial port A 9, 10, 90
- serial port B 9, 90
- serial ports 9, 90
- sixteen-button cursor 18, 19
- sixteen-button stylus feature 19
- skew correction command 74
- sound annunciator command 68
- specifications 100-103
 - environmental 103
 - performance 102
 - physical 102
- stands 127-139
- stylus 4, 8, 9, 10, 18, 19
- stylus care 46
- stylus/cursor ports 9, 10
- stylus holder 4

- TABLETMG.COM 27-31
- testing the tablet 37-40
- transmission control: start
and stop 65
- troubleshooting 47

- UIOF format 74-80
 - ASCII BCD report format 74
 - command summary 80
 - packed binary format 78, 79
- UIOFRST utility 41

- variable resolution 17, 72