

Publication 84-DM11-440
Issued April 1984

**MM 1201 & MM 961
DATA TABLETS**

Technical Reference

Summagraphics Corporation
60 Silvermine Road
Seymour, CT 06483 U.S.A.

Phone: (203) 881-5400

COPYRIGHT

This manual and the software described in it are copyrighted with all rights reserved. (Software, in the context of this copyright, can be in any form, including firmware.) Under the copyright laws, this manual or the software may not be copied, in whole or in part, without the written consent of Summagraphics, except in the normal use of the software or to make a backup copy. The same proprietary and copyright notices must be affixed to any permitted copies as were affixed to the original. This exception does not allow copies to be made for others, whether or not sold, but all of the material purchased (with all backup copies) may be sold, given or loaned to another person. Under the law, copying includes translating into another language or format. You may use the software on any computer owned by you, but extra copies cannot be made for this purpose.

Copyright Summagraphics Corporation 1984
All Rights Reserved.
Summagraphics Corporation
60 Silvermine Road, Seymour, Connecticut 06483
U.S.A.

TRADEMARKS

Summagraphics and MM are trademarks of Summagraphics Corporation.

FCC STATEMENT CONCERNING RFI

The MM series digitizer ("the Equipment") generates and uses radio frequencies. If not properly installed and used in strict accordance with Summagraphics's instructions, the Equipment may cause interference with radio or television reception. The Equipment has been tested and found to perform within the Class B limits for a computing device according to the specifications in Subpart J, Part 15 of the Federal Communications Commission (FCC) Rules, designed to provide reasonable protection against such interference in a residential installation.

Accessories or options to the Equipment must be purchased from Summagraphics to ensure compliance with the Class B specification.

Summagraphics Corporation is not responsible for radio or television interference caused by unauthorized modification of the Equipment.

Compliance with Class A specifications does not guarantee that interference will not occur in a particular installation. If it does occur, one or more of the following measures could remedy the problem:

- Re-orient the radio or television receiving antenna.
- Move the Equipment away from the radio or television.
- Plug the Equipment and the radio or television into separate outlets so that they are on different branch circuits.

If necessary, consult the radio or television dealer or an experienced technician. In addition, the booklet *How to Identify and Resolve Radio-TV Interference Problems* may be helpful. This booklet was prepared by the FCC and is available from the U.S. Government Printing Office, Washington, D.C. 20402, Stock No. 004-00-00345-4.

LIMITED WARRANTY ON MEDIA, MANUALS, AND SOFTWARE

If you discover physical defects in the software media or in the manuals distributed with the software, Summagraphics Corporation will replace the media or manuals at no charge to you, provided you return the item to be replaced with proof of purchase, including purchase date, to Summagraphics or to an authorized Summagraphics dealer during the 90-day period after you purchased the product. In some countries the replacement period may be different; check with your authorized Summagraphics dealer.

Software, in the context of this warranty, can be in any form, including firmware.

Even though Summagraphics has tested the software, SUMMAGRAPHICS MAKES NO WARRANTY OR REPRESENTATION, EITHER EXPRESS OR IMPLIED, WITH RESPECT TO THIS SOFTWARE, ITS QUALITY, PERFORMANCE, MERCHANTABILITY, OR FITNESS FOR A PARTICULAR PURPOSE. AS A RESULT, THIS

SOFTWARE IS SOLD "AS IS", AND YOU, THE PURCHASER, ARE ASSUMING THE ENTIRE RISK AS TO ITS QUALITY AND PERFORMANCE.

THE WARRANTY AND REMEDIES SET FORTH ABOVE ARE EXCLUSIVE AND IN LIEU OF ALL OTHERS, ORAL OR WRITTEN, EXPRESS OR IMPLIED, IN FACT OR IN LAW. No Summagraphics dealer, agent, or employee is authorized to make any modification, extension or addition to this warranty.

Summagraphics reserves the right to make changes to the software or its documentation without notice. IN NO EVENT WILL SUMMAGRAPHICS BE LIABLE FOR DIRECT, INDIRECT, SPECIAL, INCIDENTAL, OR CONSEQUENTIAL DAMAGES RESULTING FROM ANY DEFECT IN THE SOFTWARE OR ITS DOCUMENTATION (including but not limited to typographical, arithmetic or listing errors), even if advised of the possibility of such damages. In particular, Summagraphics shall have no liability for any programs or data stored in or used with Summagraphics's products, including the costs of recovering such programs or data.

Some states and countries do not allow the exclusion or limitation of implied warranties or liability for incidental or consequential damages, so the above limitation or exclusion may not apply to you. This warranty gives you specific legal rights, and you may also have other rights which vary from state to state, country to country.

LIMITED WARRANTY ON HARDWARE

Summagraphics warrants to the original purchaser that this equipment, including its components and parts, shall be free from defects in material and workmanship for a period of ninety (90) days from the date of shipment. Summagraphics' obligation under this warranty shall be limited to repair or replacement, at the option of Summagraphics, Seymour, Connecticut. Return of a repaired instrument shall be F.O.B. Summagraphics, Seymour, Connecticut. The above warranty is contingent upon normal usage and does not cover products which have been modified without Summagraphics' approval or which have been subjected to unusual physical or electrical stress or on which the original identification marks have been removed or altered. The above warranty will not

apply if adjustment, repair, or parts replacement is required because of accident, neglect, misuse, failure of electric power or air-conditioning, humidity control, transportation, or causes other than normal and ordinary usage. To the extent that any of its equipment is furnished by a manufacturer other than Summagraphics, the foregoing warranty shall be applicable only to the extent of the warranty furnished by such other manufacturer. This warranty will not apply to appearance terms, such as knobs, handles, dials, or the like, nor to the pen cartridge or refill of the pen cartridge.

THERE ARE NO WARRANTIES WHICH EXTEND BEYOND THE DESCRIPTION ON THE FACE HEREOF. The foregoing obligations are in lieu of all obligations and liabilities, including all warranties of implied or statutory, and waive Summagraphics' entire and exclusive liability and Purchaser's exclusive remedy for any claim of damages in connection with the sale or furnishing of all equipment, including design, suitability for use, operation or installation. In no event shall Summagraphics be liable for any special or consequential damages.

PREFACE

This book provides technical information on the MM 1201 and MM 961 data tablets. It assumes you have a general knowledge of computers, computer programming, and interfacing peripherals to a computer.

REVISION INFORMATION

This manual replaces *MM 1201 and MM 961 Technical Reference*, publication number 84-DM11-831, issued August 1983.

Nearly every page of this book has undergone at least small changes. Major changes include a new section on writing a software driver; enhanced installation instructions; and an enhanced description of combining modes.

Contents

1-1	Chapter 1	Operation Overview
2-1	Chapter 2	Communicating with the Host
2-1	Section A	Hardware Interfaces
2-1		Signal Levels
2-2		Connector Pin Assignments
2-2	Section B	Baud Rate
2-3	Section C	Report Format
2-4		MM Packed Binary
2-6		MM ASCII BCD
2-7	Section D	Notes on Initial Communications with the Host
2-8	Section E	Guidelines for Writing a Software Driver
3-1	Chapter 3	Operating Characteristics and Remote Commands
3-1	Section A	Controlling the Report Flow and Content
3-2		Primary Modes
3-2		Stream Mode
3-3		Switch Stream Mode
3-4		Point Mode
3-5		Remote Request Mode
3-6		Modifiers
3-6		Delta Mode
3-7		Increment Mode
3-10		Axis Update Mode
3-12		Report Rate
3-13		Combining Characteristics
3-14		Transmission Control
3-15	Section B	Setting the Resolution
3-16		Resolution
3-17		Grid Roundoff
3-18		Set X,Y Scale
3-20	Section C	Other Remote Commands
3-20		Origin
3-21		Tablet Identifier
3-22		Reset (to factory defaults)
3-23		Send Configuration

4-1	Chapter 4	Checking the Data Tablet
4-2	Section A	Diagnostic Functions
4-2		Self Test
4-3		Send Test Results
4-4		Echo
4-5		Code Check
4-6		Factory Test
4-7	Section B	In Case of Failure
5-1	Chapter 5	Operating Environment, Installation, Care, and Service
5-1	Section A	Operating Environment
5-1		Temperature and Humidity
5-1		Power
5-2	Section B	Unpacking and Installation
5-2		Unpacking
5-2		Installation
5-8		Changing the Stylus Refill
5-9	Section C	FCC Considerations
5-9	Section D	Care and Cleaning
5-9	Section E	Service
A-1	Appendix A	Jumper Assignments
B-1	Appendix B	Specifications
C-1	Appendix C	ASCII Conversion Chart
D-1	Appendix D	Quick Reference Sheet

Tables

2-1	Table 2-1	RS-232-C Signal Levels
2-1	Table 2-2	TTL Signal Levels
2-2	Table 2-3	RS-232-C Data/Power Cable Pin Assignments
2-2	Table 2-4	TTL Data/Power Cable Pin Assignments
2-4	Table 2-5	MM Packed Binary Report Format
2-4	Table 2-6	MM Packed Binary Report Format with Delta Mode
2-6	Table 2-7	MM ASCII BCD Report Format for MM 1201 or MM 961
3-12	Table 3-1	Maximum Report Throughput in Reports per Second
3-13	Table 3-2	Combining Operating Characteristics
3-23	Table 3-3	Output Format of Send Configuration
4-3	Table 4-1	Output Format of Send Test Results
A-2	Table A-1	Jumper Assignments of PCB, Release B
A-4	Table A-2	Jumper Assignments of PCB, Release C or Higher

Figures

1-1	Figure 1-1	MM Data Tablet
1-3	Figure 1-2	Resolution, Counts of Resolution, Absolute Coordinates, and Relative Coordinates
2-9	Figure 2-1	General Flowchart for Master Program to Read and Process Data Tablet Reports
2-10	Figure 2-2	Detail A: Get and Decode Reports Subroutine
2-11	Figure 2-3	Detail B: Data Input Subroutine
3-8	Figure 3-1	Increment Mode Example
3-11	Figure 3-2	Axis Update Example
3-20	Figure 3-3	Vertical and Horizontal Orientation of MM 961
4-1	Figure 4-1	Quick Functional Check of the Data Tablet
5-3	Figure 5-1	MM Components and Accessories
5-4	Figure 5-2	MM Components and Accessories
5-6	Figure 5-3	Stylus Holder Location
5-7	Figure 5-4	Installing the Power Adapter Cable
5-8	Figure 5-5	Changing the Stylus Refill
A-3	Figure A-1	Jumpers on MM 961, Revision B
A-3	Figure A-2	Jumpers on MM 1201, Revision B
A-4	Figure A-3	Jumpers on MM 961, Revision C or Higher
A-4	Figure A-4	Jumpers on MM 1201, Revision C or Higher

Chapter 1 *Operation Overview*

The MM is a data tablet. A data tablet is an input device. It allows you to translate graphic information into digital information, suitable for a digital device, such as a computer or a computer terminal.

The MM is valuable in many applications, including:

- steering a cursor on a computer terminal;
- picking locations on a menu;
- digitizing maps, drawings, etc.

The hardware parts of a standard MM data tablet are the tablet, cursor or stylus, and the data/power cable, shown in the following illustration:

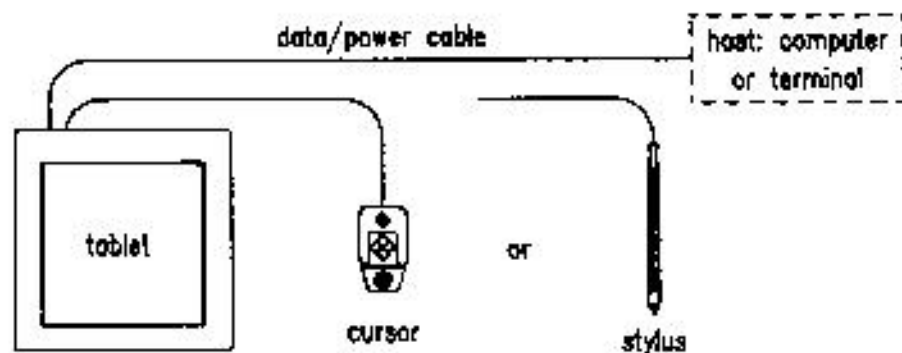

Figure 1-1 MM Data Tablet

- **Tablet:** a table-like surface. The tablet can tilt or lie flat. The MM 1201 has a nominal active area of 11.7"x11.7". The MM 961 has a nominal active area of 6"x9".
- **Cursor:** a puck-like, hand-held device. Use it with the tablet to locate points. A cursor has a cross hair for precisely sighting the points. Cursors are available with three or four buttons.
- **Stylus:** a pen-like, hand-held device. Use it with the tablet to locate points. The stylus has two buttons: one on the outside of the barrel and one inside the barrel, activated by pressing the refill tip. Refills are available in marking and non-marking.

- **Data/power cable:** the cable and connector assembly that interfaces the data tablet to the host. The MM or the host transmits data through this cable. Also, the data tablet gets its power through this cable.

Optional power supplies and adapter cables are available. Descriptions of these, as well as instructions for installing the MM, appear in Chapter 5.

The MM translates the position of the stylus or cursor on the tablet into digital information and communicates the digital information to the host. The host is usually a computer or computer terminal. The stylus or cursor position is expressed as an X,Y coordinate pair. One coordinate pair is called a report.

Reports can only be collected when the stylus or cursor is in the tablet's active area and is in proximity. The active area is the area on the tablet surface in which cursor or stylus positions can be identified. Proximity is the maximum distance above the active area that the cursor or stylus can be held and report a valid position. This, in effect, establishes a three-dimensional volume, within which the cursor or stylus can issue valid reports. Reports issued from outside of this volume are out of proximity and, therefore, do not represent the current position of the stylus or cursor.

Reports are in counts of resolution, expressed as absolute coordinates or relative coordinates, depicted in the following illustration:

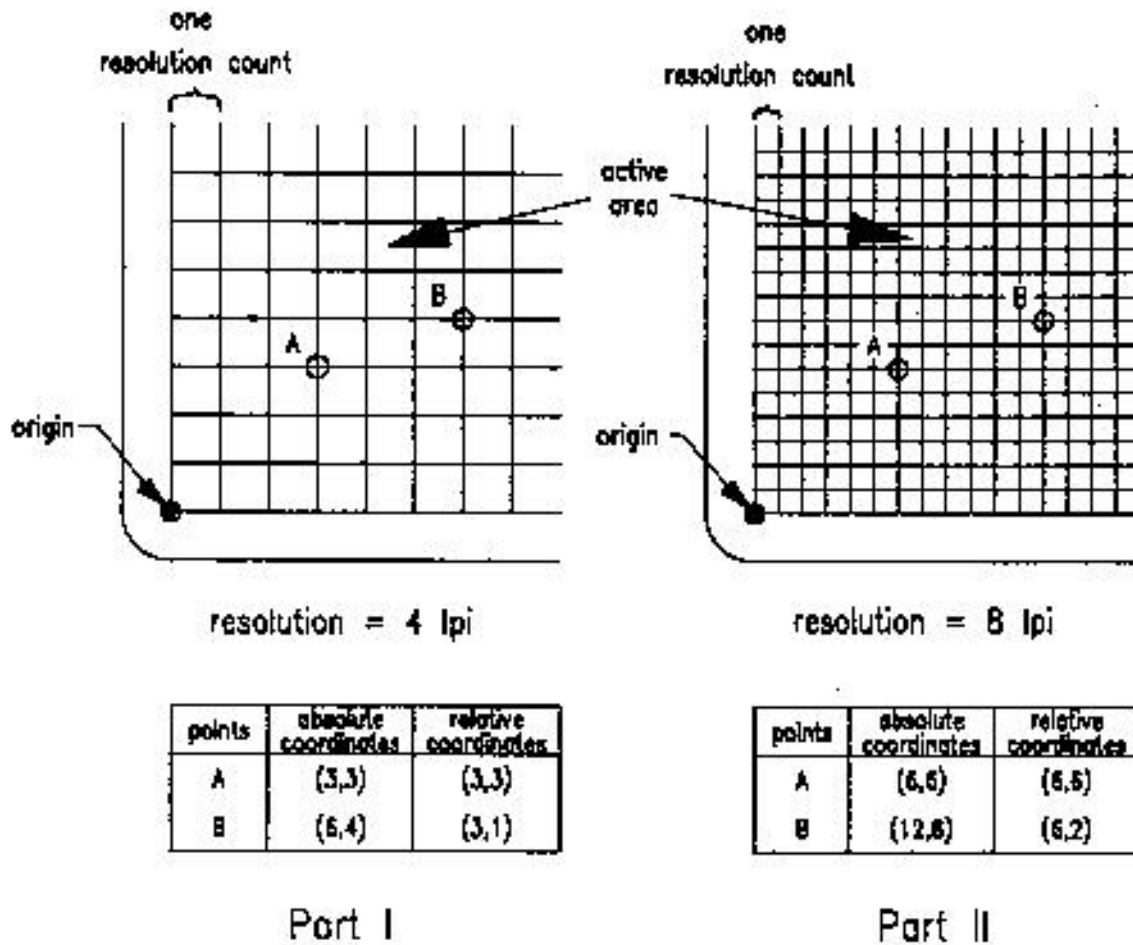

Figure 1-2 Resolution, Counts of Resolution, Absolute Coordinates, and Relative Coordinates

Resolution is the smallest distance or movement that the data tablet can distinguish. Resolution is a measure of precision and is expressed in lines per inch (lpi) or lines per millimeter (lpm).

Counts of resolution is a unit of measure: one count is the distance between two lines of resolution. In Figure 1-2, points A and B are in the same physical location, but their coordinates are different. This is because the resolution in Part I is 4 lpi, and the resolution in Part II is 8 lpi.

Absolute coordinates are coordinates measured from the the tablet's **origin** (0,0). **Relative coordinates** are measured "relative to" the last report location. In Figure 1-2, point B is reported after point A. Therefore, point B in relative coordinates is reported as relative to point A. Reports are in absolute coordinates, except when the MM is in Delta Mode.

Delta Mode is one of the MM's many operating characteristics. Other characteristics govern when reports are issued; how fast they are issued; the tablet origin location; and the tablet resolution. Set the operating characteristics with remote commands from the host. (Refer to Chapter 3.)

Also, use remote commands to initiate the diagnostic functions, described in Chapter 4. These functions aid in troubleshooting a malfunctioning unit.

Chapter 2 *Communicating with the Host*

For successful communication between an MM and its host, the hardware interface, baud rate, report format, and command format must be compatible. This chapter describes the alternatives in each category, except command formats, which are described in Chapter 3.

This chapter also provides notes on the initial communications with the host and guidelines for writing a software driver.

SECTION A **HARDWARE INTERFACES**

The MM is available with either an RS-232-C or a TTL interface. Both interfaces are full duplex, asynchronous, and serial. They use the same protocol. However, they use different signal levels and connector pin assignments.

SIGNAL LEVELS

The tables below specify the signal levels for data transmissions:

Table 2-1 RS-232-C Signal Levels

	Interchange Voltage	
RS-232-C Interface	-3V to -12V	+3V to +12V
Binary states	1	0
Signal condition	Mark	Space

Table 2-2 TTL Signal Levels

	Interchange Voltage	
TTL Interface	0V to +0.6V	+2.4V to +5V
Binary states	1	0
Signal condition	Mark	Space

EIA Standard RS-232-C: Interface Between Data Terminal Equipment and Data Communication Equipment Employing Serial Binary Data Interchange, by the Engineering Department of the Electronic Industries Association (Washington, D.C.: EIA, 1969) is the source for Table 2-1. Table 2-2 has the same format because the TTL interface operates similarly. Refer to that publication for definitions of the terms used in these tables.

CONNECTOR PIN ASSIGNMENTS

The data/power cable is a single, shielded cable. The RS-232-C version has a 25-pin male D connector. The TTL version has a 9-pin male D connector. Tables 2-3 and 2-4 identify the pin assignments. Pins not shown are not assigned.

Table 2-3 RS-232-C Data/Power Cable Pin Assignments

Pin	Wire Name	Description
1	protective ground	frame ground
2	transmit data	serial data from MM to host
3	receive data	serial data and commands from host to MM
7	signal ground	return for serial data and power
9	+12V supply	power for tablet from host: 0.25A at +/-10% regulation
15	-12V supply	power from host: 0.1A, +/-10% regulation for RS-232-C driver

Table 2-4 TTL Data/Power Cable Pin Assignments

Pin	Wire Name	Description
1	protective ground	frame ground
2	transmit data	serial data from MM to host
3	receive data	serial data and commands from host to MM
7	signal ground	return for serial data and power
9	+12V supply	power for tablet from host: 0.25A at +/-10% regulation

Adapter cables are available for the RS-232-C interface to:

- separate the power lines from the data/power cable for use with an external power source;
- change connector gender (male to female); or
- reverse the transmit and receive lines (pins 2 and 3).

SECTION B BAUD RATE

Baud rate is the number of bits transmitted each second between host and peripheral (MM) or peripheral and host. Two baud rate configurations are available: a fixed rate of 9600 or a variable rate (between 75 and 19,200) that conforms to the host's baud rate. The latter option is called autobaud.

The MM is configured at the factory to one of the baud rate configurations, usually the fixed baud rate setting (9600). You can change the baud rate configuration by removing or attaching jumpers inside the MM tablet. This is described in Appendix A.

Note: For a host whose baud rate is generated from something other than a crystal-controlled clock, we do not recommend using the autobaud feature. This is because the MM could miscalculate the baud rate, especially for very low rates.

If the MM is set up with autobaud, then each time the MM is powered up, send an ASCII space character (SP). The MM uses that character to time the host's baud rate, then sets its own to match.

SECTION C REPORT FORMAT

Two report formats are available, packed binary or ASCII BCD.

(Note to users of other Summagraphics data tablets or digitizers: The formats described here are specific to the MM series. Other Summagraphics products have similarly named formats, but their content may be different.)

Regardless of format, reports are in counts of resolution, not in inches or millimeters. (Counts of resolution is described in Chapter 1.)

You can choose to have parity enabled or not. If enabled, the parity is odd.

The MM is normally configured at the factory with the five-byte, packed binary format and parity is enabled. However, this can be changed by attaching or removing jumpers inside the MM. Instructions appear in Appendix A.

MM PACKED BINARY

The packed binary format varies, depending on whether the tablet is in Delta Mode or not. In Delta Mode, each report consists of three bytes. When the data tablet is not in Delta Mode, each report consists of five bytes. The formats appear on the next page.

Table 2-5 MM Packed Binary Report Format

Stop Bit	P	MSB								LSB	Start Bit	Transmission Sequence
		7	6	5	4	3	2	1	0			
1	P	PH	PR	T	Sx	Sy	Fc	Fb	Fa	0	1st byte	
1	P	0	X6	X5	X4	X3	X2	X1	X0	0	2nd byte	
1	P	0	X13	X12	X11	X10	X9	X8	X7	0	3rd byte	
1	P	0	Y6	Y5	Y4	Y3	Y2	Y1	Y0	0	4th byte	
1	P	0	Y13	Y12	Y11	Y10	Y9	Y8	Y7	0	5th byte	

Table 2-6 MM Packed Binary Report Format with Delta Mode

Stop Bit	P	MSB								LSB	Start Bit	Transmission Sequence
		7	6	5	4	3	2	1	0			
1	P	PH	PR	T	Sx	Sy	Fc	Fb	Fa	0	1st byte	
1	P	0	X6	X5	X4	X3	X2	X1	X0	0	2nd byte	
1	P	0	Y6	Y5	Y4	Y3	Y2	Y1	Y0	0	3rd byte	

Key to Tables 2-5 and 2-6:

LSB least significant bit

MSB most significant bit

F flag bit identifying the stylus or cursor buttons being pressed:

Stylus Buttons	3-button Cursor Buttons*	4-button Cursor Buttons	Binary Output		
			Fc	Fb	Fa
none	none	none	0	0	0
tip button	1	1	0	0	1
barrel button	2	2	0	1	0
tip and barrel	—	3	0	1	1
—	3	4	1	0	0
—	1+2	1+2	0	1	1
—	—	1+3	0	1	1
—	1+3	1+4	1	0	1
—	—	2+3	0	1	1
—	2+3	2+4	1	1	0
—	—	1+2+3	0	1	1
—	1+2+3	1+2+4	1	1	1
—	—	2+3+4	1	1	1
—	—	1+2+3+4	1	1	1

* On the 3-button cursor, the buttons are distinguished by raised dimples, rather than by numbered labels. In the table above, 1 corresponds to one dimple; 2 to two dimples, etc.

Sy or Sx sign bit for Y or X coordinate: 1 is positive, 0 is negative. (In Delta Mode, the sign can be positive or negative. When not in Delta Mode, the sign is positive.)

T Tablet Identifier, choice of 0 or 1, selectable by remote command (see Chapter 3)

PR proximity: 0 is in proximity, 1 is out of proximity

PH phasing bit, set to 1

P parity bit (optional)

X0 to X13 X coordinate bits

Y0 to Y13 Y coordinate bits

MM ASCII BCD

The ASCII BCD format varies, depending on the resolution setting and on whether the tablet is in Delta Mode or not. The format also differs with the model, MM 1201 or MM 961. The formats appear below:

Table 2-7 MM ASCII BCD Report Formats for MM 1201 or MM 961

MM 1201

Resolution	Report Format when Not Using Delta Mode	Report Format when Using Delta Mode
1 to 508 tpi	XXXX,YYYY,F<CR><LF>	S0XXX,S0YYY,F<CR><LF>
1000 or 1016 tpi (40 lpm)	XXXXX,YYYYY,F<CR><LF>	S00XXX,S00YYY,F<CR><LF>

MM 961

Resolution	Report Format when Not Using Delta Mode	Report Format when Using Delta Mode
1 to 1016 tpi (40 lpm)	XXXX,YYYY,F<CR><LF>	S0XXX,S0YYY,F<CR><LF>

Key to Table 2-7:

- S coordinate sign, ASCII + or -
- 0 ASCII zero
- X a digit of the X coordinate, where each digit is an ASCII character, 0 through 9
- ,
- the delimiter character, an ASCII comma
- Y a digit of the Y coordinate, where each digit is an ASCII character, 0 through 9

(cont.)

F flag character, identifying the stylus or cursor buttons being pressed;

Stylus Buttons	3-button Cursor Buttons*	4-button Cursor Buttons	ASCII Character Output
none	none	none	0
tip button	1	1	1
barrel button	2	2	2
tip and barrel	—	3	3
—	3	4	4
—	1+2	1+2	3
—	—	1+3	3
—	1+3	1+4	5
—	—	2+3	3
—	2+3	2+4	6
—	—	1+2+3	3
—	1+2+3	1+2+4	7
—	—	2+3+4	7
—	—	1+2+3+4	7

* On the 3-button cursor, the buttons are distinguished by raised dimples, rather than by numbered labels. In the table above, 1 corresponds to one dimple; 2 to two dimples, etc.

<CR> ASCII carriage return

<LF> ASCII line feed

SECTION D NOTES ON INITIAL COMMUNICATIONS WITH THE HOST

- From the time the MM is powered up or from the time the Reset command is issued, there is a 10 millisecond delay before the MM is ready to receive commands from the host.
- If the tablet is configured with autobaud, your first action must be to send an ASCII space character (SP) from the host to the data tablet. This sets the baud rate.

Note: If the host's baud rate is generated from something other than a crystal-controlled clock, the MM could miscalculate the baud rate, especially for very low rates.

- The first time an MM is powered up, send the Code Check command and record the checksum. (The Code Check function is described in Chapter 4.)

SECTION E GUIDELINES FOR WRITING A SOFTWARE DRIVER

If the MM is connected to a computer, rather than to a terminal, the computer must have a driver for the MM. The driver is a software program that collects and decodes MM reports for use by another (master) program. This section provides some guidelines, in the form of flowcharts, for writing a driver.

The flowcharts are for an MM using the packed binary report format. The steps are general for any set of operating characteristics. Remote Request Mode and Delta Mode require additional steps. These are highlighted by dotted or dashed lines.

Figure 2-1 is a flowchart of the overall driver. Figures 2-2 and 2-3 are subroutine details.

Note: In the context of these charts, "normalize" means to combine the two coordinate bytes into the format required by your master program.

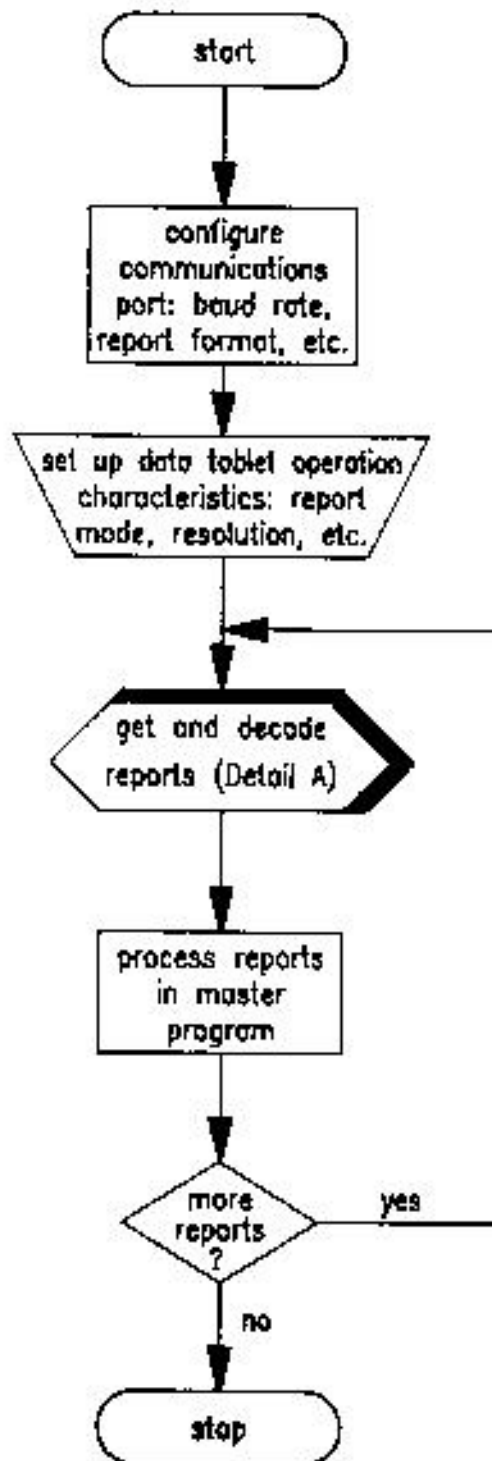

Figure 2-1 General Flowchart for Master Program to Read and Process Data Tablet Reports

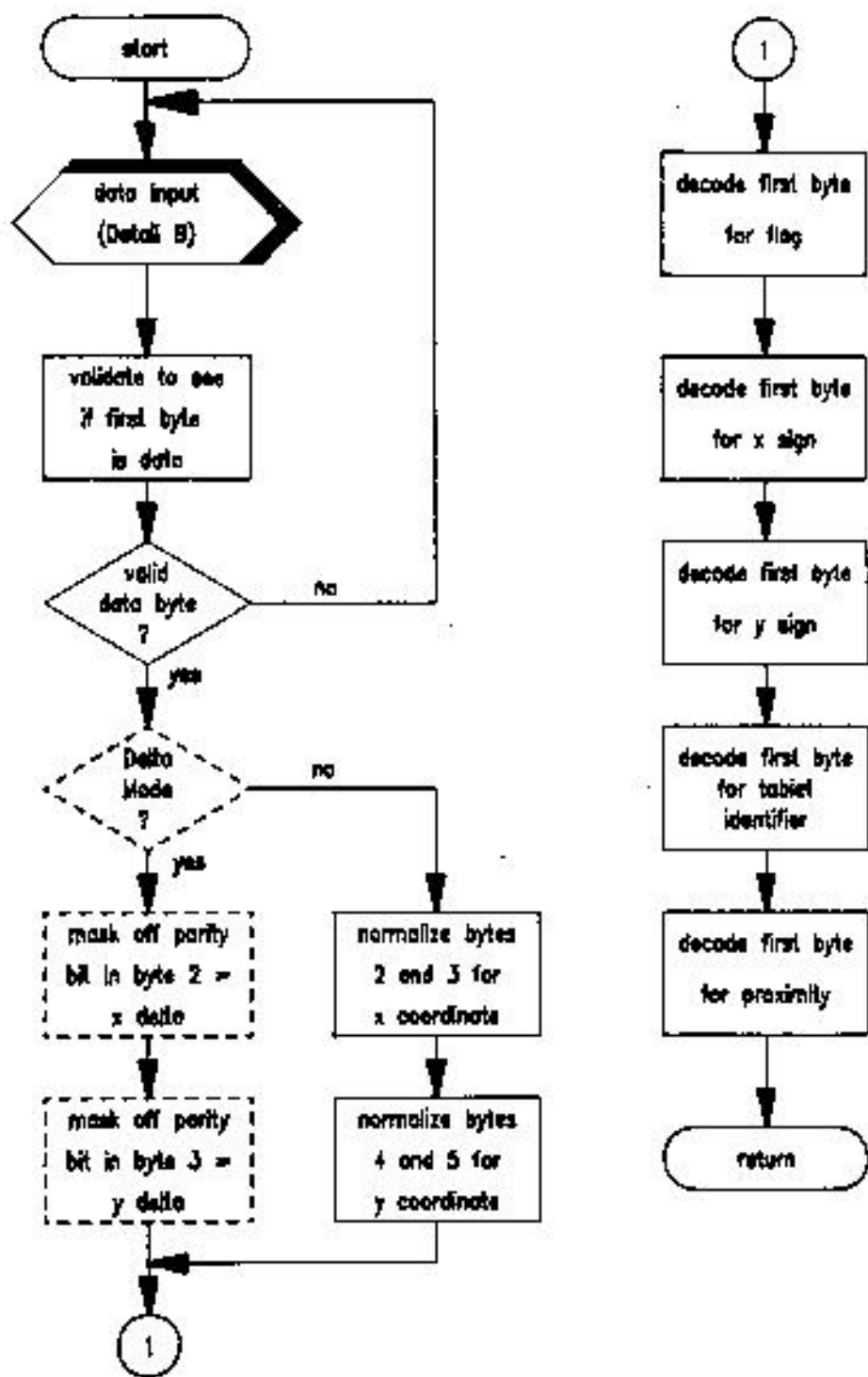

Figure 2-2 Detail A: Get and Decode Reports Subroutine

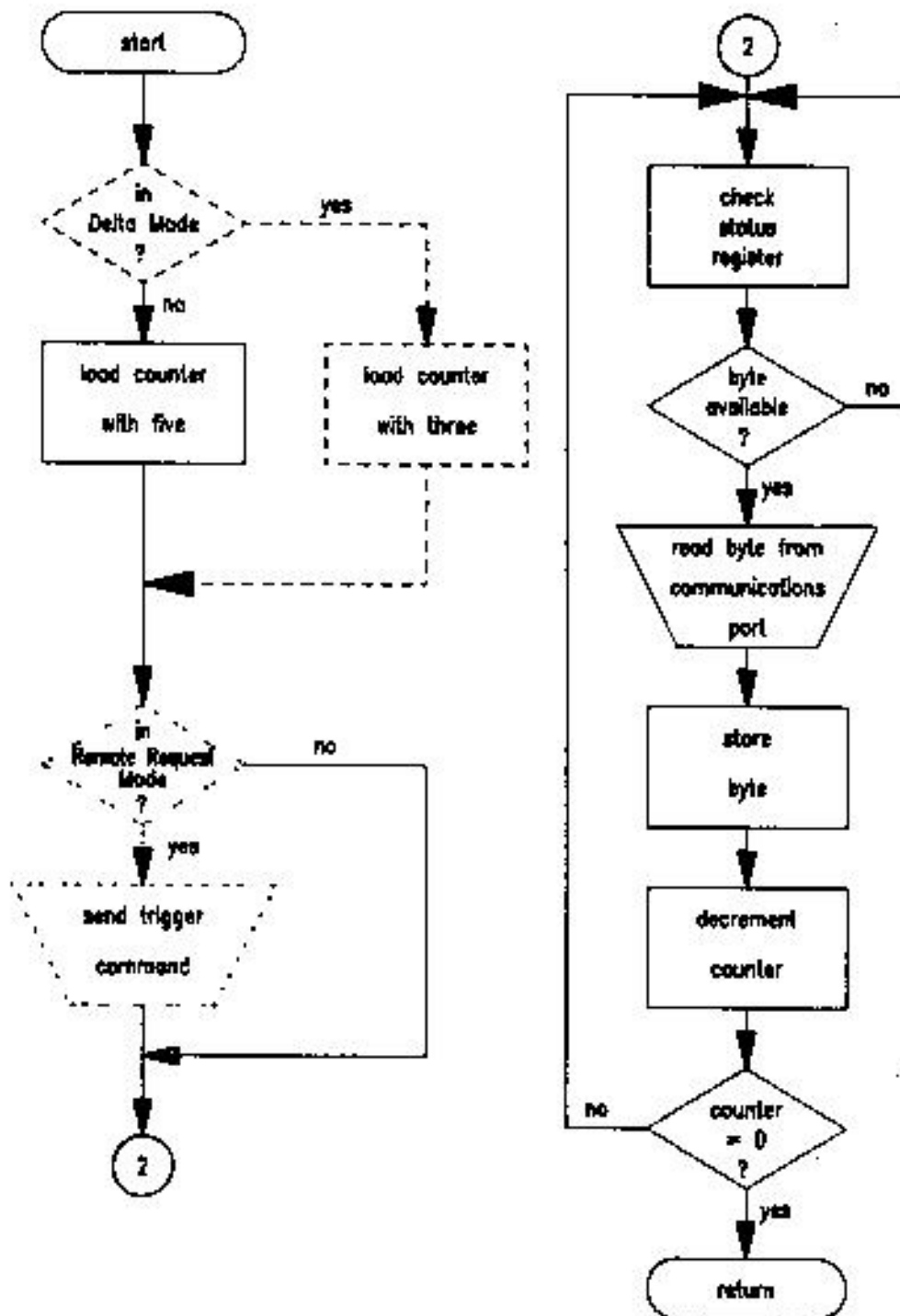

Figure 2-3 Detail B: Data Input Subroutine

Chapter 3 *Operating Characteristics and Remote Commands*

The MM has a variety of operating characteristics. Most of these:

- control the flow of reports; or
- set the resolution.

Set an MM's operating characteristics with remote commands from the host. In the following pages, each characteristic and its remote commands are defined. For easy reference, the commands appear in ASCII and hexadecimal. The choice is yours. (Appendix C, "ASCII Conversion Chart", also provides the binary, decimal, and octal conversions.)

The command byte format uses the same conventions as those used in the report formats: one start bit, eight data bits, an optional parity bit, and a stop bit.

Most commands are one byte long. Others, like Increment Mode and Set X,Y Scale, require more bytes. The MM command buffer can hold ten bytes; therefore, up to ten bytes can be sent to the MM in quick succession.

So that the MM will be operable upon arrival at your facility, the MM is set up at the factory to default to certain characteristics. The MM defaults to these settings each time it's powered up or when the Reset command is issued. A list of the defaults appears in the Reset command section and in Appendix D.

A summary of the remote commands appears in Appendix D, "Quick Reference Sheet".

SECTION A CONTROLLING THE REPORT FLOW AND CONTENT

Use the operating characteristics described in this section to control:

- when reports are issued;
- how fast they are issued; and
- the coordinate system.

Furthermore, reports can be gated (allowed to flow or not) with the Start and Stop Transmission commands.

Some characteristics are called **modifiers** because they are used in combination with a **primary mode**. Primary modes are Stream, Switch Stream, Point, and Remote Request modes. Modifiers are Delta, Increment, and Axis Update modes, as well as Report Rate. Certain combinations are valid; others are not. For further information, refer to "Combining Characteristics", near the end of this section.

PRIMARY MODES

Stream Mode

Command Syntax: <command>

	ASCII	Hex
command	@	40

In Stream Mode, the MM continuously issues reports. It is not necessary to press a cursor or stylus button.

If the cursor or stylus is out of proximity and no buttons are pressed, the last valid report is transmitted three times. If a button is pressed, the last valid report is issued continuously. (In both cases, if the report format is packed binary, the proximity bit is set to one, indicating that the cursor or stylus is out of proximity.)

Hint: To eliminate redundant reports from being issued when the cursor or stylus is stationary, use Stream Mode together with Increment Mode, setting the increment value to one.

Switch Stream Mode

Command Syntax: <command>

	ASCII	Hex
command	A	41

In Switch Stream Mode, the MM continuously issues reports when a cursor or stylus button is pressed.

If the cursor or stylus is out of proximity and a button is pressed, the last valid report is issued continuously. (If the report format is packed binary, the proximity bit is set to one, indicating that the cursor or stylus is out of proximity.)

Point Mode

Command Syntax: <command>

	ASCII	Hex
command	B	42

In Point Mode, the MM issues one report when a cursor or stylus button is pressed.

If the cursor or stylus is out of proximity and a button is pressed, the last valid report is reissued once. (If the report format is packed binary, the proximity bit is set to one, indicating that the cursor or stylus is out of proximity.)

Remote Request Mode

Command Syntax: <mode command><trigger command>

	ASCII	Hex
mode command	D	44
trigger command	P	50

In Remote Request Mode, the MM issues one report each time the host sends a trigger command. Issue the mode command once. Thereafter, send only a trigger command for each report.

If the cursor or stylus is out of proximity, the last valid report is reissued each time a trigger command is sent. (If the report format is packed binary, the proximity bit is set to one, indicating that the cursor or stylus is out of proximity.)

After Remote Request Mode is initiated, the MM takes between two and ten milliseconds to issue the report resulting from the first trigger command. Subsequent reports can be issued up to the maximum report throughput defined in Table 3-1.

MODIFIERS

Delta Mode

Command Syntax: <command>

	ASCH	Hex
command	E	45

In Delta Mode, the MM issues reports as relative coordinates, rather than as absolute coordinates. Relative coordinates are measured "relative to" the last issued report. Whereas, absolute coordinates are measured from the tablet origin.

In Delta Mode, reports can have positive or negative values.

Reports issued while the cursor or stylus is out of proximity are zero. (If the report format is packed binary, the proximity bit is set to one, indicating that the cursor or stylus is out of proximity.)

Increment Mode

Command Syntax: <mode command><increment value>

	ASCII	Hex
mode command	I	49
increment value	SP to z	20 to 7A

In Increment Mode, the MM sends a report only when the cursor or stylus has traveled a minimum distance in the X or Y direction. This minimum distance is the increment. The increment is defined by you and applies to both axes. Because redundant reports are not sent to the host, Increment Mode is useful in reducing data output.

Note: We don't recommend using Increment Mode with low tablet resolutions, e.g. 50 lpi or lower. The results do not adhere to Increment Mode's definition.

Here is a description of how Increment Mode works: The last report issued becomes the center of an imaginary square, whose sides are twice the increment value. The cursor can move anywhere inside the imaginary square without a report being issued. As soon as the increment is satisfied along either axis, the MM transmits the actual X and Y coordinates of the point. The new point becomes the center of a new, imaginary square.

Example: Figure 3-1 illustrates operation in this mode. Part A shows the imaginary square created around each report point; the increment is five. Part B shows the reports issued as the cursor or stylus travels across the tablet; the increment is 10.

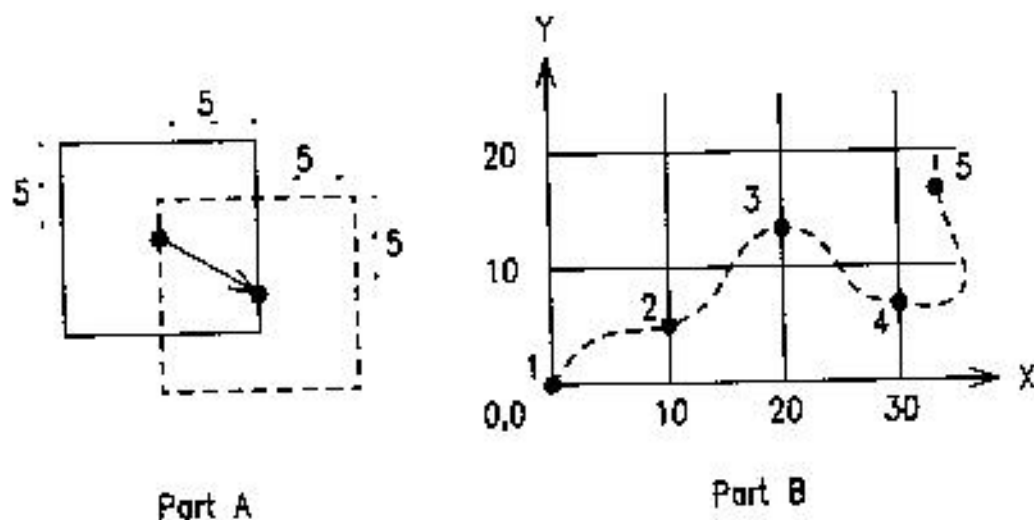

Figure 3-1 Increment Mode Example

The five points issued in part B are numbered in order.

Point	Report	Description
1	(0,0)	
2	(10,5)	Only X is satisfied. The actual value of Y is transmitted.

No point is transmitted between points 2 and 3 because the cursor or stylus did not move 10 resolution counts in either the X or the Y direction.

3	(20,13)	The increment is satisfied from the last point along the X axis, only; the MM issues the new report.
4	(30,7)	The increment is satisfied from the last point along the X axis, only; the MM issues the new report.
5	(32,17)	The increment is satisfied from the last point along the Y axis, only; the MM issues the new report.

To use Increment Mode, send the mode command, followed by the increment value. An increment value is in counts of resolution and can be a whole number from 0 to 90. (The default is zero.) Add 32, a required offset, to the desired increment, then convert the sum into your preferred format. For example, if the desired increment value is 10,

desired increment	+	32	=	increment value in decimal	=	increment value in hexadecimal	=	increment value in ASCII
10	+	32	=	42 decimal	=	2A hexadecimal	=	* ASCII

To disable Increment Mode, set the increment to zero with the ASCII space character (SP).

Axis Update Mode

Command Syntax: <mode command><update value>

	ASCII	Hex
mode command	G	47
update value	SP to z	20 to 7A

Axis Update Mode is particularly useful if you are using a grid on the tablet, and you want reports sent only at grid intersection points. In this case, we recommend positioning the cursor or stylus on a grid intersection point before initiating Axis Update Mode.

Similar to Increment Mode, in Axis Update Mode, the MM sends a report only when a set distance is satisfied in either the X or Y direction. The distance is defined by you and applies to both axes. Unlike Increment Mode, the MM sends the last transmitted value of the axis for which the update value is not satisfied.

Here is how Axis Update Mode works: Every time the cursor or stylus returns to proximity, the MM uses the first report as a reference point. From that reference point, an imaginary grid emanates with grid intervals equal to the update value. Each time the cursor or stylus crosses a grid line, a report is sent.

Example: Figure 3-2 illustrates the series of points transmitted in an example where (0,0) is the first report.

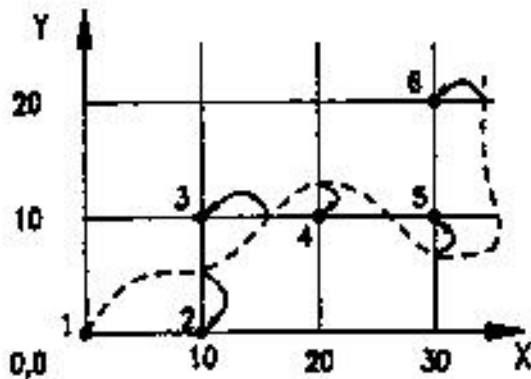

Figure 3-2 Axis Update Example

The five points issued are numbered in order. The Axis Update value equals 10.

Point	Report	Description
1	(0,0)	Reference point.
2	(10,0)	Only X is satisfied; Y retains its last value.
3	(10,10)	Only Y is satisfied; X retains its last value.
4	(20,10)	Only X is satisfied; Y retains its last value.

No point is issued between 4 and 5 because the same report is not issued consecutively.

5	(30,10)	Only X is satisfied; Y retains its last value.
6	(30,20)	Only Y is satisfied; X retains its last value.

To use Axis Update Mode, send the mode command, followed by the update value. An update value is in counts of resolution and can be a whole number from 0 to 90. (The default is zero.) Add 32, a required offset, to the desired value, then convert the sum into your preferred format. For example, if the desired update value is 10,

desired update	+	32	=	update value in decimal	=	update value in hexadecimal	=	update value in ASCII
10	+	32	=	42 decimal	=	2A hexadecimal	=	* ASCII

To disable Axis Update Mode, set the update value to zero with the ASCII space character (SP).

Report Rate

Command Syntax: <command>

	ASCII	Hex
Report Rate equal to:		
max. throughput	Q	51
max. throughput/2	R	52
max. throughput/8	S	53
max. throughput/32	T	54

The Report Rate is the number of reports the data tablet issues each second. Use it with Stream or Switch Stream Mode. The rate can be set to the maximum report throughput or to some factor (1/2, 1/8, or 1/32) of the maximum.

The maximum report throughput appears in the table below. These numbers represent the maximum number of reports that can be issued when the data tablet is in Stream, Switch Stream, or Remote Request Mode. When these modes are combined with other modes, e.g. Increment or Axis Update Mode, the throughput is affected. (Refer to the following section, "Combining Characteristics", for further information.)

Note that the maximum report throughput depends on the baud rate at which the data tablet is set; the report format; and whether the tablet is in Delta Mode or not.

Table 3-1 Maximum Report Throughput in Reports per Second (rps)

Baud Rate	Packed Binary Format 5-byte (not Delta Mode)	Packed Binary Format 3-byte (Delta Mode)	ASCII BCD* Format (approximately)
19,200	166	200	94
9,600	116	157	55
4,800	70	102	30
2,400	39	60	16
1,200	20	33	8
600	10.6	17	4
300	5.4	8.4	2
150	3.7	4.1	1

* The maximum report throughput can vary from these numbers when the data tablet is in Delta Mode or with the resolution setting.

COMBINING CHARACTERISTICS

The table below identifies the possible combinations of operating characteristics. Notes appear under the table that highlight some of the nuances of these combinations.

Table 3-2 Combining Operating Characteristics

Modifiers	Primary Modes			
	Stream	Switch Stream	Point	Remote Request
Increment	valid	valid	invalid	valid
Axis Update	valid	valid	invalid	valid
Delta	valid	valid	invalid	valid
Report Rate	valid	valid	invalid	invalid

- Increment Mode and Axis Update Mode cannot be combined with each other.
- When you combine Axis Update Mode with Stream or Switch Stream Mode and a stylus or cursor button is pressed, the last report is reissued each time the button is pressed.
- When you combine Increment Mode with Stream or Switch Stream Mode and a stylus or cursor button is pressed, no report is issued until the increment is met.
- When you combine Remote Request Mode with Increment or Axis Update Mode, reports are issued as follows:
 - If the increment or update value has been met before you issue a trigger, the triggered report equals or exceeds the last report.
 - If the increment or update value has not been met before you issue a trigger, no report is transmitted. If the increment or update value is then met, a report is not transmitted until a trigger is issued.
 - If the increment or update value has not been met before you issue a trigger and you issue a trigger at the same time you press a cursor or stylus button, the last valid report is reissued.
- Remote Request Mode or Point Mode override the Report Rate.
- The Report Rate affects Stream or Switch Stream Mode when combined with Increment or Axis Update Mode. Because the MM controls the Report Rate with an internal trigger, reports are issued as follows:
 - If the increment or update value has been met before the MM issues a trigger, the triggered report equals or exceeds the report that satisfies the increment or update.
 - If the increment or update value has not been met before the MM issues a trigger, no report is transmitted.

TRANSMISSION CONTROL

Command Syntax: <command>

	ASCII	Hex
Stop Transmission	DC3	13
Start Transmission	DC1	11

The Start Transmission and Stop Transmission commands act as gates, allowing reports to be sent or not sent from the MIM to the host. These commands control data flow, regardless of the report mode. (Stop Transmission and Start Transmission are equivalents of the transmission protocols XOFF and XON.)

Stop Transmission places the data tablet on standby. It is useful for systems that do not constantly use the data tablet. End the standby state by sending the Start Transmission command.

If a report is interrupted by Stop Transmission, no data is lost. The report is severed at the end of the byte. When the Start Transmission command is issued, the next byte in that report is sent, intact. To avoid corrupted data, the host software should not look for a phasing bit at the beginning of resumed transmission.

SECTION B SETTING THE RESOLUTION

Resolution is the smallest distance or movement that the data tablet can distinguish. Resolution is a measure of precision and is expressed in lines per inch (lpi) or lines per millimeter (lpm).

The tablet resolution can be set with the functions Resolution, Grid Roundoff, or Set X,Y Scale. Grid Roundoff and Set X,Y Scale lend themselves to certain applications. For example:

- Grid Roundoff, in effect, divides the tablet into a grid. This simplifies setting up the tablet for applications using menus, scaled maps, etc.
- Set X,Y Scale matches the tablet resolution to the resolution of another two-dimensional object. This simplifies mapping the tablet to a terminal screen, a photo, an X-ray, etc.

RESOLUTION

Command Syntax: <command>

	ASCII	Hex
Resolution setting of:		
10 lpm (254 lpi)	f	66
20 lpm (508 lpi)	i	69
40 lpm (1016 lpi)	q	71
100 lpi	d	64
200 lpi	e	65
400 lpi	s	67
500 lpi	h	68
1000 lpi	j	6A

Use the Resolution command to set the MM to one of the resolutions listed in the table above.

GRID ROUNDOFF

Command Syntax: <command>

	ASCH	Hex
Roundoff setting of:		
1 lpi	l	6C
2 lpi	n	6E
4 lpi	p	70

Use Grid Roundoff to set the tablet resolution to one, two, or four lines per inch. This, in effect, divides the tablet into a 1 inch, 1/2 inch, or 1/4 inch grid.

SET X,Y SCALE

Command Syntax:

<mode command><X low byte><X high byte><Y low byte><Y high byte>

	ASCII	Hex
mode command	r	72
X axis resolution low byte	not applic.	00 to FF
X axis resolution high byte	not applic.	00 to FF
Y axis resolution low byte	not applic.	00 to FF
Y axis resolution high byte	not applic.	00 to FF

Use Set X,Y Scale to match the tablet resolution to the resolution of another two-dimensional object. Set X,Y Scale lets you define the resolution of each axis, independently. Resolutions can be from 1 to 508 lines per inch. The following instructions describe how to use Set X,Y Scale:

1. Determine the resolution for the entire length of the axis. If the number is fractional, round it to the next higher whole number:
 - If the object's resolution is expressed as one number, encompassing the axis, ensure that the corresponding MM axis' length divides evenly into that number. If it doesn't, the MM truncates the resolution value to a whole number.

For example: When matching a vertically-oriented MM 961 to a vertically-oriented terminal with resolutions of 800 pixels (horizontal) by 1024 pixels (vertical), the X axis resolution is 800; the Y axis resolution is 1024. However,

object's resolution / axis length

$$\begin{array}{l} 800 \quad / \quad 6 \text{ inches} = 133.33 \text{ per inch} \\ 1024 \quad / \quad 9 \text{ inches} = 113.77 \text{ per inch} \end{array}$$

The MM would truncate these numbers to 133 and 113. Therefore, round them to 134 and 114, respectively. Re-multiply the rounded number by the axis length to derive the resolution for the entire axis.

134 x 6 inches = 804 is the X axis resolution
 114 x 9 inches = 1026 is the Y axis resolution

- If the object's resolution is expressed in units per inch, e.g. 37 lines per inch, multiply that number by the corresponding MM axis' length. For example, for an MM 1201:

object's resolution x length of the corresponding MM axis = axis resolution

37 lpi x 11.7 inches = 432.9

Round the number to the next higher whole number (433).

2. Convert the axis resolution value to a hexadecimal number. For example:

804 decimal = 324 hexadecimal

3. If the number is less than four digits, pack the number with zeros to the left. For example, express the number 324 as 0324.
4. Separate the hexadecimal number into two two-digit parts, the least significant byte (low byte) and the most significant byte (high byte). For example, separate the number 0324 into:

0324 = 03 24
 high byte low byte

5. Repeat the steps given above for the other axis.
6. Send the Set X,Y Scale commands in the prescribed sequence:

<mode command><X low byte><X high byte><Y low byte><Y high byte>

An example: The command sequence for a vertically-oriented MM 961 matched to a vertically-oriented terminal with resolutions of 804 pixels (horizontal) by 1026 pixels (vertical) is:

r24030204 where the mode command is in ASCII

7224030204 where the mode command is in hexadecimal

Note: To change the resolution of only one axis, send zeros for the value of the axis you want to remain unchanged.

7. To verify the resolution settings, use the Send Configuration command.

ORIGIN

Command Syntax: <command>

	ASCII	Hex
Origin location:		
Horizontal (961) or Upper Left (1201)	b	62
Vertical (961) or Lower Left (1201)	c	63

Use the Origin command to define the location of the tablet's origin (0,0).

On the MM 1201, the origin can be assigned to the lower left corner or the upper left corner. The default location is the lower left corner. (When the origin is in the upper left corner, the Y coordinates are positive, not negative. This departure from the standard Cartesian coordinate system is to aid in the compatibility between the MM and terminals with a screen origin in the upper left corner.)

On the MM 961, the origin can be assigned to the lower left corner of the tablet in a vertical or horizontal orientation (depicted below). The default orientation is vertical.

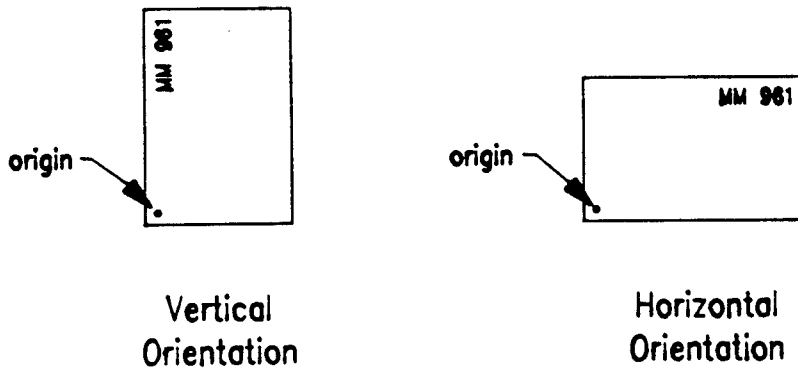

Figure 3-3 Vertical and Horizontal Orientation of MM 961

TABLET IDENTIFIER

Command Syntax: <command>

	ASCII	Hex
Tablet Identifier equal to:		
zero	0	30
one	1	31

Use Tablet Identifier to set a bit in the packed binary report format to a one or a zero. This can be helpful in dual-tablet systems to distinguish between the reports coming from one tablet versus the other.

RESET (TO FACTORY DEFAULTS)

Command Syntax: <command>

	ASCII	Hex
Reset	nul	00

Use Reset to run the Self Test diagnostic function and return the MM operating characteristics to the factory-set defaults. The defaults are:

Resolution ... 500 lpi
Report Rate ... maximum
Report Mode ... Switch Stream
Increment ... 0
Axis Update ... 0
Origin:
 MM 961 ... for vertical orientation
 MM 1201 ... lower left corner
Tablet Identifier ... 0

Reset does not affect the autoband setting.

Note: After Reset is issued, there is a 10 millisecond delay before the MM is ready to receive information from the host.

SEND CONFIGURATION

Command Syntax: <command>

	ASCII	Hex
Send Configuration	a	61

Use Send Configuration to send a report to the host that identifies the Tablet Identifier setting and the resolution setting of each axis.

The last item is especially helpful to verify a Set X,Y Scale setting. The report format is as follows:

Table 3-3 Output Format of Send Configuration

Stop Bit	P	MSB								LSB	Start Bit	Transmission Sequence
		7	6	5	4	3	2	1	0			
1	P	PH	PR	T	Sx	Sy	0	0	0	0	0	Flag byte
1	P	0	b6	b5	b4	b3	b2	b1	b0	0	0	X low byte
1	P	0	b13	b12	b11	b10	b9	b8	b7	0	0	X high byte
1	P	0	b6	b5	b4	b3	b2	b1	b0	0	0	Y low byte
1	P	0	b13	b12	b11	b10	b9	b8	b7	0	0	Y high byte

Key to Table 3-3:

LSB	least significant bit
MSB	most significant bit
P	parity (optional)
PH	phasing bit, set to 1
PR	proximity bit, set to 0
T	Tablet Identifier bit, 1 or 0
Sx and Sy	sign bits, set to 1 (positive)
b0 to b13	maximum X or Y value at set resolution

Chapter 4 *Checking the Data Tablet*

A quick, functional check of the data tablet can be performed by connecting the MM to a terminal and moving the cursor or stylus across the tablet's active area. The X and Y values should increase as the cursor or stylus slides from the tablet origin toward the end of the axis. This is depicted in the following illustration, where the origin is located at the lower left corner:

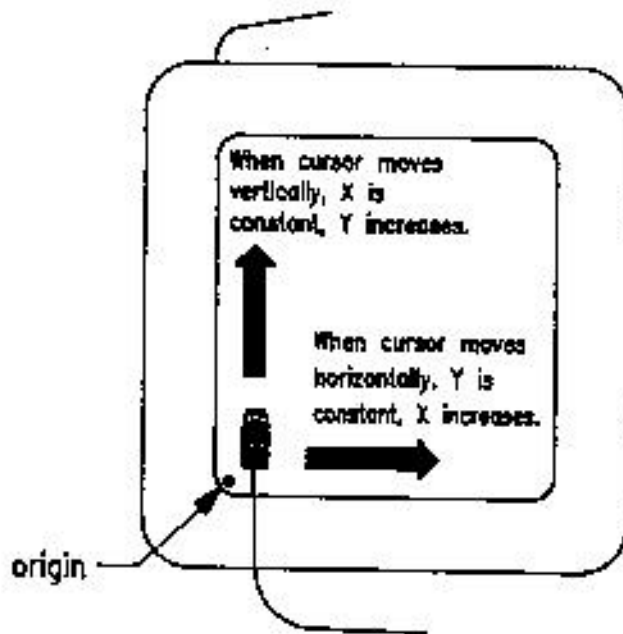

Figure 4-1 Quick Functional Check of the Data Tablet

Other mechanisms for checking an MM are the diagnostic functions: Self Test, Send Test Results, Echo, and Code Check.

Like the MM's operating characteristics, the diagnostic functions are initiated by remote commands from the host. Each function and its command are described in this chapter.

This chapter also provides guidelines for what to do if a unit is malfunctioning.

SECTION A DIAGNOSTIC FUNCTIONS

SELF TEST

Command Syntax: <command>

	ASCII	Hex
Self Test	t	74

Use Self Test to perform tests on the tablet and cursor or stylus. Self Test checks:

- the analog circuitry;
- the cursor or stylus connection, operation, and location; and
- the digital circuitry.

Self Test is automatically performed each time the power to the data tablet is turned on or the Reset command is issued. You can also initiate it with the command appearing above. The test results are stored in the data tablet and can be accessed with the Send Test Results command.

SEND TEST RESULTS

Command Syntax: <command>

	ASCII	Hex
Send Test Results	w	77

Use **Send Test Results** to transmit the results of the most recently performed **Self Test** to the host. The results are transmitted in one byte with the following format:

Table 4-1 Output Format of Send Test Results

Stop	MSB								LSB	Start
Bit	8	7	6	5	4	3	2	1	0	Bit
1	P	T	0	0	0	PR	D	C	A	0

- A analog circuitry test; pass = 1, fail = 0
- C cursor/stylus connection and cursor/stylus coil operation test; pass = 1, fail = 0
- D digital circuitry test; pass = 1, fail = 0
- PR cursor/stylus on/off tablet; on = 1, off = 0
- T total test result. (This result is based only on the results of tests A, C, and D.) Pass = 1, fail = 0.

ECHO

Command Syntax: <command>

	ASCII	Hex
Echo	k	6B

Use Echo to ensure that the interface between the MM and the host is operating correctly. Issue the Echo command, then issue any character sequence. In turn, each character is transmitted to the MM and echoed back to the host. If the interface is working properly, the sent character matches the echoed character.

Note that the character sequence is passed through, not acted upon by, the MM. Therefore, remote commands issued while Echo is in effect are ignored by the MM.

Issuing the Reset command or powering down the unit aborts the Echo function.

CODE CHECK

Command Syntax: <command>

	ASCII	Hex
Code Check	x	78

Use Code Check to identify the version of firmware in the MM or to detect a change in the firmware.

The Code Check function issues a number, called the **checksum**, to the host. The checksum uniquely identifies the version of firmware in the MM.

When your MM first arrives, record the checksum. Each time a Code Check is performed, the checksum should be the same. A change in the checksum means a change has occurred in the firmware.

The checksum is in the following six-byte format:

#HHHH

where HHHH is a hexadecimal number in ASCII. The checksum is in this format, regardless of the format being used for data reports.

FACTORY TEST

Command Syntax: Do not use this command. It is for factory use only.

	ASCII	Hex
Factory Test	z	7A

Do not issue the Factory Test command. It is documented here only for completeness.

If you issue the command by mistake, powering down the unit clears the function. The Reset command does not clear it.

SECTION B IN CASE OF FAILURE

If the MM fails to operate or fails the diagnostics, follow these steps:

1. Power down the MM.
2. Check that cables are firmly attached.
3. Ensure that the host is working properly.
4. If possible, issue each diagnostic command and review the results.

If the MM is still malfunctioning, contact Summagraphics' Customer Service department. The address and phone number appear in Chapter 5.

Chapter 5 *Operating Environment, Installation, Care, and Service*

This chapter provides information on:

- the recommended operating environment for the MM;
- unpacking and installing the MM;
- caring for and cleaning the MM; and
- whom to contact for service.

SECTION A OPERATING ENVIRONMENT

TEMPERATURE AND HUMIDITY

Operate the MM within these temperature and humidity ranges:

+45 degrees to +110 degrees Fahrenheit
+7 degrees to +43 degrees Celsius
8% to 80% relative humidity, non-condensing

Acceptable non-operating conditions are:

-45 degrees to +145 degrees Fahrenheit
-43 degrees to +63 degrees Celsius
8% to 80% relative humidity, non-condensing

Extremes in environment can cause degradation of operation.

POWER

An MM with an RS-232-C interface requires 0.25A at +12VDC with +/-10% regulation and 0.1A at -12VDC with +/-10% regulation.

An MM with a TTL interface requires 0.25A at +12VDC with +/-10% regulation.

Note: If the MM is powered from an independent power supply rather than from the host, an MM power supply must be used. Specifications appear in Appendix B. Contact your local Summagraphics representative for part numbers and prices.

SECTION B UNPACKING AND INSTALLATION

UNPACKING

Immediately upon receipt, inspect the package for damage. If damage exists:

1. Open the package and inspect the damage.
2. Report the damage to the carrier as soon as possible, preferably within 72 hours or receipt.
3. Record the damaged items on the freight bill.
4. Write to the carrier: state that the shipment was damaged, when it was received, and request an inspection.
5. Keep the shipment in its original container until an inspection is made by the carrier.
6. Notify Summagraphics Corporation's Traffic Department immediately. (Use the same address and telephone number given later in this chapter for Customer Service.)

Otherwise, unpack the MM. The package should include:

- one tablet with data/power cable attached
- one set (four) rubber feet
- one *MM 1201 and MM 961 Data Tablets Technical Reference*

Purchasable options include a:

- cursor
- stylus
- power adapter, gender changer, or reversing cable
- power supply

INSTALLATION

A brief summary of the steps for assembling and installing an MM are as follows:

1. Configure the MM data tablet.
2. Adjust the tilt or use flat.
3. Attach stylus holder, if applicable.
4. Connect the stylus or cursor to the tablet.
5. Connect the tablet to the host.
6. Connect the tablet to the power source.

Detailed illustrations and instructions follow.

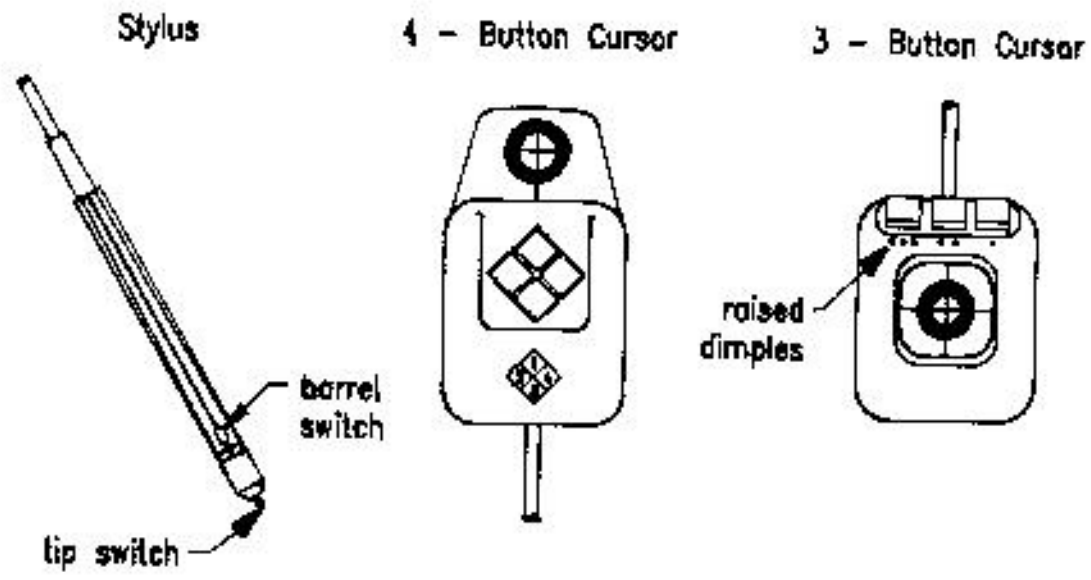
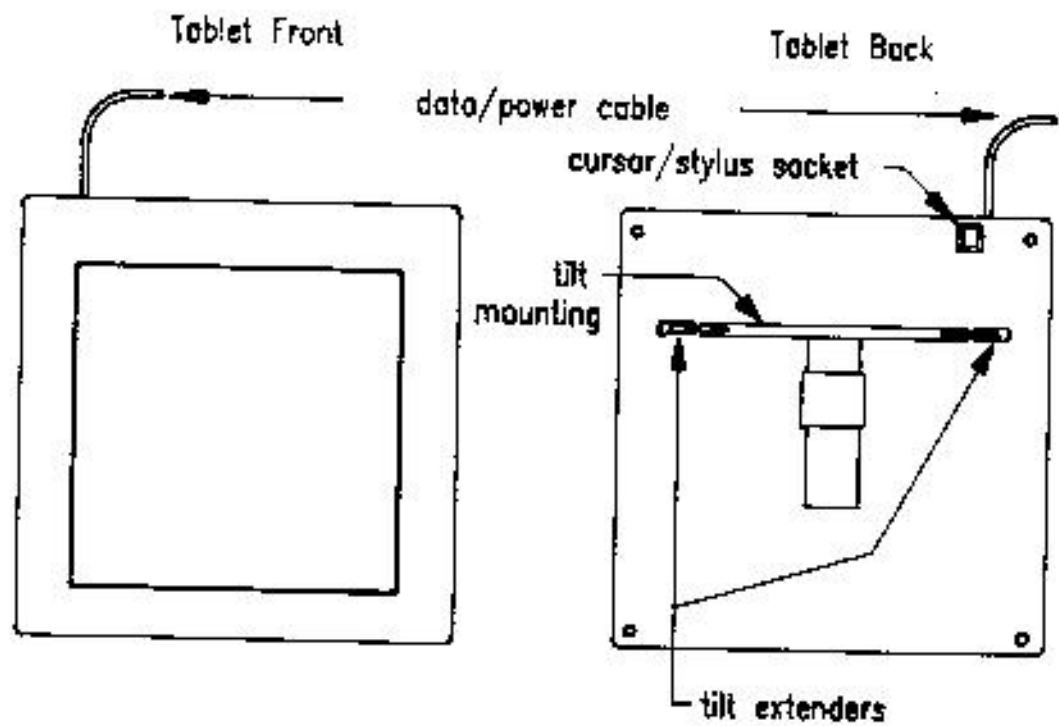

Figure S-1 MM Components and Accessories

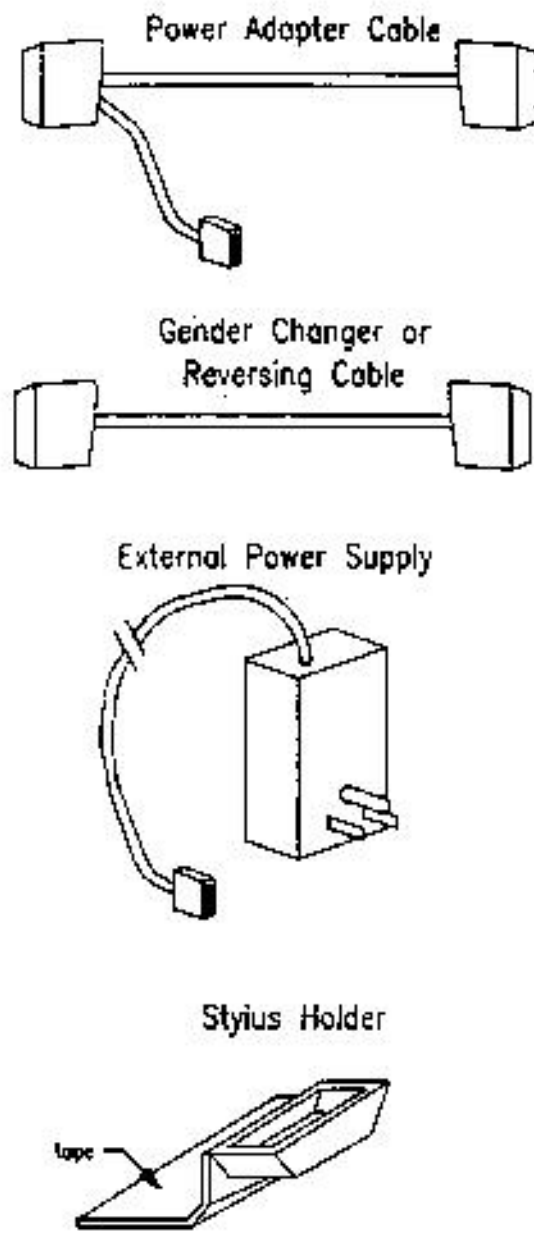

Figure 5-2 MM Components and Accessories

1. Configure the MM Data Tablet

The MM is configured at the factory to your specifications. These specifications include the baud rate option, report format, and parity setting. (Chapter 2 explains these specifications.)

If, however, you want to change the configuration, you can do so by removing or attaching jumpers on the printed circuit board (PCB) inside the tablet case. (For complete instructions, refer to Appendix A.) It is advantageous to do this step first since it requires disassembling the tablet.

CAUTION: The PCB contains delicate and electrostatically sensitive components. Read Appendix A for handling instructions before disassembling the tablet case.

2. Adjust the Tilt or Use Flat

The MM tablet can tilt or lie flat. The tilt mounting is already attached to the back of the tablet when shipped. The MM 961 tilts either four and one half degrees or five and one half degrees, depending on its orientation. The MM 1201 tilts four to six degrees or ten to fourteen degrees, depending on the position the extenders.

For the tablet to lie flat, the tilt mounting must be removed and the four rubber feet attached to the tablet bottom:

- Slide the tilt mounting toward the edge of the tablet where the data/power cable protrudes.
- Lift the tilt mounting gently to clear the cursor/stylus socket. Remove the tilt assembly.
- Remove the paper backing from the rubber feet. Stick the feet on the tablet back, approximately one inch from each corner.

3. Attach Stylus Holder (if applicable)

Attach the stylus holder anywhere along the tablet edge within five inches from the tablet top. Refer to the illustration below:

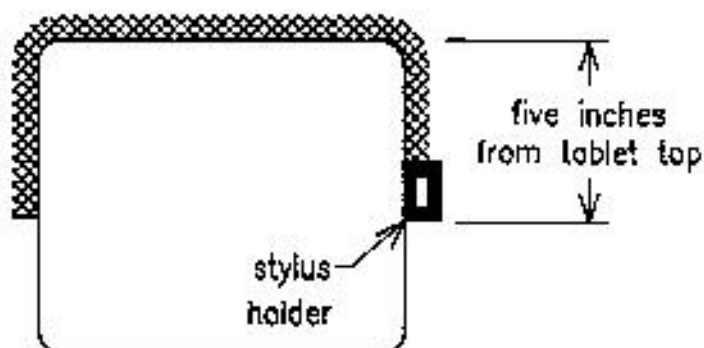

Figure 5-3 Stylus Holder Location

Remove the protective paper from the adhesive tape. Attach the taped side to the back of the tablet.

4. Connect the Stylus or Cursor to the Tablet

The stylus or cursor plugs into a "phone" jack on the under side of the tablet.

Cursors and styli are interchangeable. Upon changing from a stylus to a cursor or from a cursor to a stylus, reset the tablet by powering it down or by issuing the Reset command.

Note: When the tablet is powered and the stylus is plugged in but not in use, store the stylus in the stylus holder. This allows air to freely circulate around the tip. Not providing air circulation could damage the stylus from overheating.

5. Connect the Tablet to the Host

The MM has one of the following data/power cables:

- An RS-232-C interface cable with a 25-pin male D connector with a jack screw. The host must have a 25-pin female D connector (AMP P/N 205207-1). To lock the connectors together, the host connector must have a female screwlock (AMP P/N 205817-1).

If your system requires them, adapter cables are available to change the connector gender from male to female; or to reverse the transmit and receive lines (pins 2 and 3). Install an adapter cable between the MM data/power cable and the host.

- A TTL interface cable with a 9-pin male D connector with a jack screw. The host must have a 9-pin female D socket (AMP P/N 205203-1). To lock the connectors together, the host must have a female screwlock (AMP P/N 205817-1).

6. Connect the Tablet to the Power Source

You have a choice of powering the MM from the host or from one of the MM power supplies. If the MM is powered from the host, power is provided through the data/power cable. Therefore, the connection is made in step 4, above.

If, however, the MM is powered from one of the MM power supplies, the power adapter cable must be installed between the data/power cable, the host, and the power supply, as shown in the illustration:

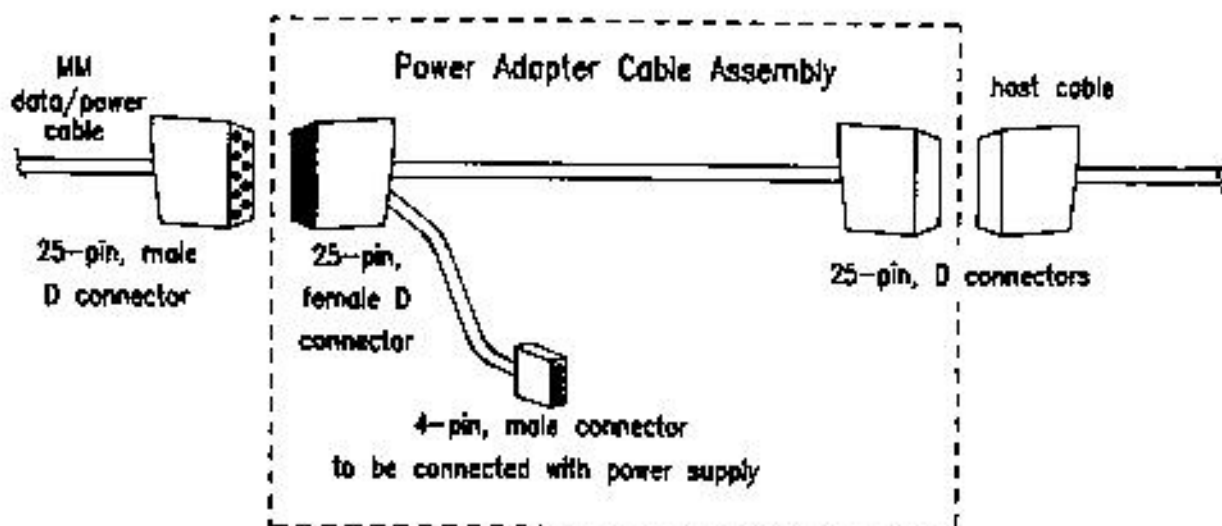

Figure 5-4 Installing the Power Adapter Cable

CHANGING THE STYLUS REFILL

As depicted in the illustration below, to change the stylus refill, pull the cap straight out; likewise, the refill. Replace the refill and the cap.

Note: Do not remove the metal guide-ring in the cap. It keeps the refill in place.

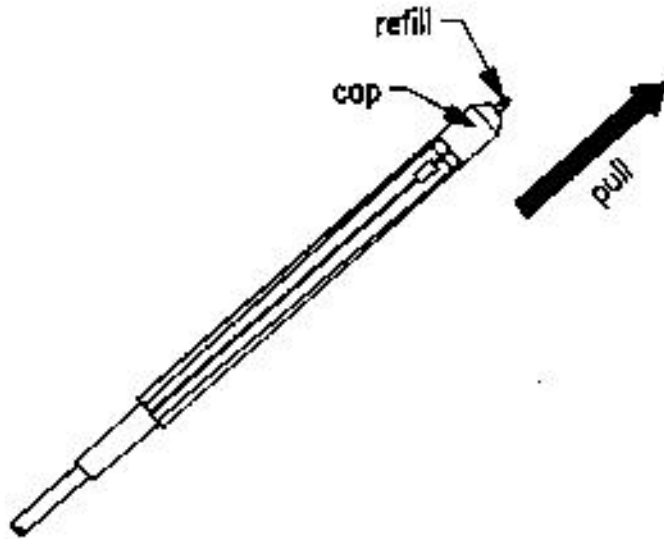

Figure 5-5 Changing the Stylus Refill

SECTION C FCC CONSIDERATIONS

As stated in the FCC statement at the front of this book, the MM must be installed and operated in accordance with the procedures appearing in this manual.

In addition, to ensure that EMI shielding requirements are met, the host's interface cabling connector must have a metal shroud, grounded to the host chassis.

SECTION D CARE AND CLEANING

Avoid sharply banging or dropping the tablet, cursor, or stylus.

Never immerse any part in fluid.

Disconnect the tablet from its power source before cleaning it.

The MM tablet surface is made of plastic. To clean, use only a cotton flannel cloth with mild detergent and water. Never use a hydrocarbon cleaner such as acetone, or an abrasive cloth. These mar the tablet finish.

SECTION E SERVICE

For technical support and service, contact Summagraphics Corporation at this address:

Customer Service Department
Summagraphics Corporation
60 Silvermine Road
Seymour, Connecticut 06483

(203) 881-5400

If you return an MM for repair, a Return Authorization Number must be on the outside of the package and on all accompanying paperwork. Obtain a Return Authorization Number from Summagraphics' Customer Service department. When contacting Customer Service, please have ready the tablet serial number and the purchase order number.

Do not ship any equipment to Summagraphics without a Return Authorization Number.

Appendix A Jumper Assignments

The parity, baud rate option, or report format can be changed on the MM by removing or attaching jumpers. A jumper is a tiny plastic cap containing a U-shaped metal wire. The jumpers are located on the printed circuit board (PCB) inside the tablet case.

CAUTION

Disconnect the tablet from its power source before opening the case.

Special care must be taken when the tablet case is open. Components on the PCB, especially the microprocessor, can be damaged or destroyed by electrostatic discharges. This can be avoided by preventing static electricity from building up. Here are some guidelines:

- *Have an antistatic floor covering under you and the tablet.*
- *Use a conductive, grounded work surface.*
- *Keep yourself at ground potential with conductive wrist bands and a 1 megohm resistor to ground.*
- *Do not wear clothes or shoes made of materials that promote static electricity, e.g. nylon, polyester, or wool.*

To access the board, lay the tablet upside down on a table. Remove the phillips-head screws along the outer edge. Gently remove the tablet back. The jumpers are located along the edge containing the cursor/stylus connector. Use that connector as a landmark in locating the jumpers.

The following tables and figures identify the jumper assignments and locations. Table A-1 and Figures A-1 and A-2 are for Revision B printed circuit boards. Table A-2 and Figures A-3 and A-4 are for Revision C, or higher, printed circuit boards.

Table A-1 Jumper Assignments of PCB, Release B

Board Labels Figure A-1	Board Labels Figure A-2	Jumper attached/removed	Configuration
Set X,Y	Set X,Y	attached	packed binary format
Set X,Y	Set X,Y	removed	ASCII BCD format
BDR	BDR	attached	fixed baud rate of 9600
BDR	BDR	removed	autobaud
Z9-17*	Z10-17*	*	parity (odd) enabled
Z9-17*	Z10-17*	*	parity disabled

* Note: On Release B of the PC board, parity is assigned to pin 17 of the microprocessor. Leaving the electrical connection intact configures the report format with a parity bit. Breaking that connection configures the report format with no parity bit. You can break the connection by bending the pin or cutting the run to ground. Both procedures are delicate and should only be performed if you are experienced in working with this type of hardware. The instructions are as follows:

- Bending the pin: First remove the microprocessor from its socket.

CAUTION: The microprocessor is a costly and delicate item. Remove it from its socket very carefully.

Bend pin 17 outward, away from the microprocessor. Bend it just enough to clear the microprocessor socket. Take care; the pin can break easily. Bending the pin back to its original shape is also likely to break it off; therefore, make this change with great discretion. When inserting the microprocessor into its socket, align the notch as shown in Figures A-1 or A-2.

- Cutting the run to ground: This is a permanent alteration!! Cut the run to ground for pin 17. Be careful to not cut adjoining runs.

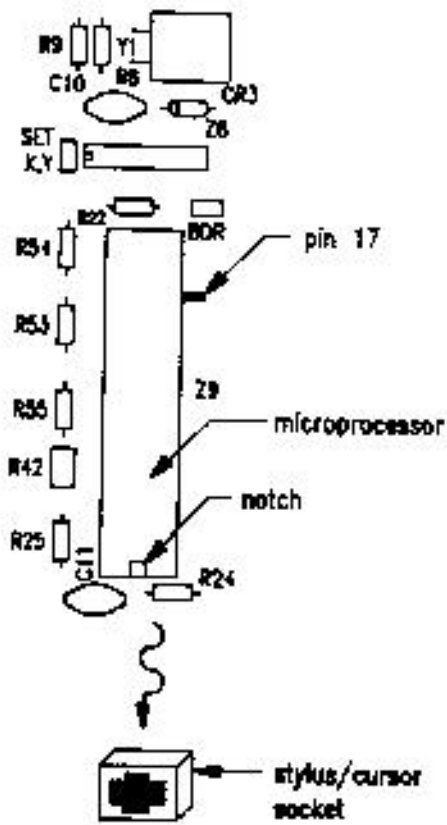

Figure A-1 Jumpers on MM 961, Revision B

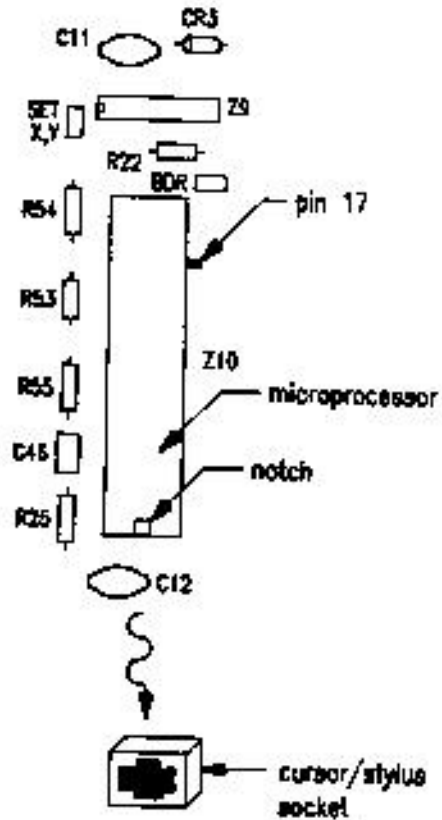

Figure A-2 Jumpers on MM 1201, Revision B

Table A-2 Jumper Assignments of PCB, Release C or Higher

Board Labels in Figures A-3 and A-4	Jumper attached/removed	Configuration
AB	attached	packed binary format
AB	removed	ASCII BCD format
AA	attached	fixed band rate of 9600
AA	removed	autobaud
AC	attached	parity (odd) enabled
AC	removed	parity disabled

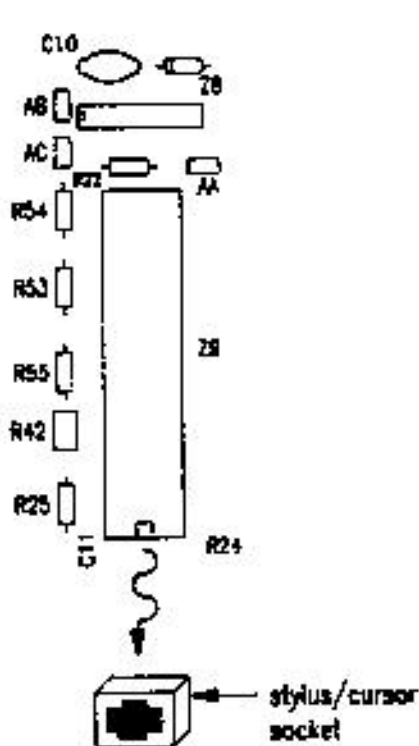

Figure A-3 Jumpers on MM 961, Revision C or Higher

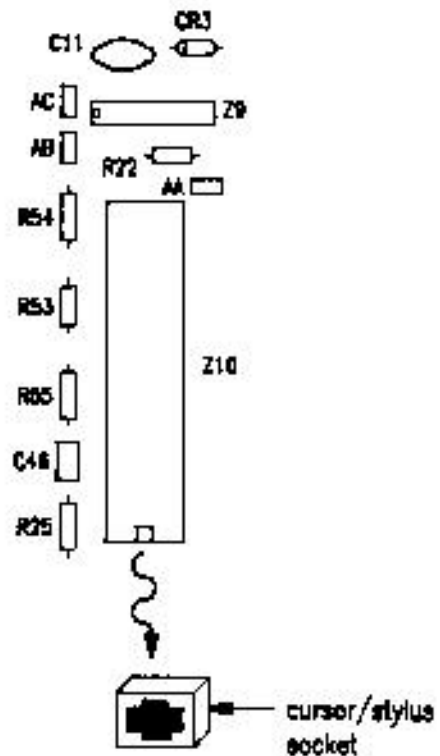

Figure A-4 Jumpers on MM 1201, Revision C or Higher

Appendix B Specifications

PHYSICAL DESCRIPTION

Model	Overall Dimensions	Active Area (nominal)	Weight
MM 961	9.69" x 12.94" x 0.74"	6" x 9"	max. 4 lbs.
	246mm x 329mm x 19mm	153mm x 229mm	1.8kg
MM 1201	16.0" x 16.2" x 0.80"	11.7" x 11.7"	max. 7 lbs.
	406mm x 412mm x 20mm	297 mm x 297 mm	3.2kg

POWER REQUIREMENTS

- RS-232-C Interface: 0.25A at +12VDC & 0.1A at -12VDC with +/-10% regulation
- TTL Interface: 0.25A at +12VDC with +/-10% regulation

OPTIONAL POWER SUPPLIES

- U.S.A.: 102V to 132V, 58Hz to 62Hz, NEMA 5-15P plug
- International: 197V to 264V, 48Hz to 52Hz, I.E.C. Universal power receptacle (power cable with European plugs sold separately)
- Japan: 90V to 110V, 42Hz to 62Hz, NEMA 1-15P plug

MATERIAL AND COSMETICS

- Color: pearl white
- Finish: matte (silk-like)
- Material: Cycolac KJW flame-retardant ABS plastic

OPERATING SPECIFICATIONS

An MM performs to the specifications listed below. The word "typical" is used to describe accuracy and proximity. Typical means the unit performs to that specification over more than 90 percent of the active area at 25 degrees Celsius. A slight degradation occurs at the extreme edges and corners of the active area.

The following specifications are provided to aid in the understanding and use of the product. For detailed specifications, refer to the Summagraphics engineering document *Standard OEM Version MM 1201 and MM 961 Specification*.

Proximity ... 0.5" (12.7mm) typical

Proximity is the maximum distance the cursor or stylus can be held above the active area and report the position of the stylus or cursor.

Accuracy ... +/- 0.025" (.625mm) typical

Accuracy is how closely a point's actual location is determined.

Jitter ... cursor: +/-1 least significant bit; stylus: +/-2 least significant bits

Jitter is the difference in values collected by the data tablet for the same point (for example, 10.999, 11.000, 11.001). Jitter is caused by electrical noise in the tablet's analog circuitry. Noise affects the signal that identifies a point. Jitter is measured as one unit of the set resolution.

Repeatability ... +/- 0.010" (.250mm) or better

Repeatability is how closely you receive the same coordinates from the tablet when repeatedly locating the point. Repeatability takes temperature range and jitter into consideration.

Cursor Eccentricity ... +/-0.005" (.125) or better

Cursor eccentricity is how much the electrical center varies from the cross hair center as the cursor is rotated through 360 degrees.

Appendix C

ASCII Conversion Chart

Decimal	Binary 7 6 5 4 3 2 1 0	Octal	Hex	ASCII Character	Control Function or Character Description
0	00000000	000	00	NUL	Null
1	00000001	001	01	SOH	Start of Heading
2	00000010	002	02	STX	Start of Text
3	00000011	003	03	ETX	End of Text
4	00000100	004	04	EOT	End of Transmission
5	00000101	005	05	ENQ	Enquiry
6	00000110	006	06	ACK	Acknowledge
7	00000111	007	07	BEL	Bell
8	00001000	010	08	BS	Backspace
9	00001001	011	09	HT	Horizontal Tab
10	00001010	012	0A	LF or NL	Line Feed or New Line
11	00001011	013	0B	VT	Vertical Tab
12	00001100	014	0C	FF	Form Feed
13	00001101	015	0D	CR or RT	Carriage Return
14	00001110	016	0E	SO	Shift Out
15	00001111	017	0F	SI	Shift In
16	00010000	020	10	DLE	Data Link Escape
17	00010001	021	11	DC1	Device Control 1
18	00010010	022	12	DC2	Device Control 2
19	00010011	023	13	DC3	Device Control 3
20	00010100	024	14	DC4	Device Control 4
21	00010101	025	15	NAK	Negative Acknowledge
22	00010110	026	16	SYN	Synchronous Idle
23	00010111	027	17	ETB	End Transmission Block
24	00011000	030	18	CAN	Cancel
25	00011001	031	19	EM	End of Medium
26	00011010	032	1A	SUB	Substitute
27	00011011	033	1B	ESC	Escape
28	00011100	034	1C	FS	File Separator
29	00011101	035	1D	GS	Group Separator
30	00011110	036	1E	RS	Record Separator
31	00011111	037	1F	US	Unit Separator
32	00100000	040	20	SP	Space
33	00100001	041	21	!	Exclamation Point
34	00100010	042	22	"	Double Quote
35	00100011	043	23	#	Number or Pound
36	00100100	044	24	\$	Dollar
37	00100101	045	25	%	Percent
38	00100110	046	26	&	Ampersand
39	00100111	047	27	'	Apostrophe, Right Single Quote
40	00101000	050	28	(Left Parenthesis
41	00101001	051	29)	Right Parenthesis
42	00101010	052	2A	*	Asterisk
43	00101011	053	2B	+	Plus or Addition
44	00101100	054	2C	,	Comma
45	00101101	055	2D	-	Hyphen

cont.

Decimal	Binary 7 6 5 4 3 2 1 0	Octal	Hex	ASCII Character	Control Function or Character Description
46	001011110	056	2E	.	Period
47	001011111	057	2F	/	Slash
48	001100000	060	30	0	
49	001100001	061	31	1	
50	001100010	062	32	2	
51	001100011	063	33	3	
52	001100100	064	34	4	
53	001100101	065	35	5	
54	001100110	066	36	6	
55	001100111	067	37	7	
56	001110000	070	38	8	
57	001110001	071	39	9	
58	001110010	072	3A	:	Colon
59	001110011	073	3B	;	Semicolon
60	001110100	074	3C	<	Less Than
61	001110101	075	3D	=	Equals
62	001110110	076	3E	>	Greater Than
63	001110111	077	3F	?	Question Mark
64	010000000	100	40	@	Commercial At
65	010000001	101	41	A	
66	010000010	102	42	B	
67	010000011	103	43	C	
68	010000100	104	44	D	
69	010000101	105	45	E	
70	010000110	106	46	F	
71	010000111	107	47	G	
72	010010000	110	48	H	
73	010010001	111	49	I	
74	010010010	112	4A	J	
75	010010011	113	4B	K	
76	010010100	114	4C	L	
77	010010101	115	4D	M	
78	010010110	116	4E	N	
79	010010111	117	4F	O	
80	010100000	120	50	P	
81	010100001	121	51	Q	
82	010100010	122	52	R	
83	010100011	123	53	S	
84	010100100	124	54	T	
85	010100101	125	55	U	
86	010100110	126	56	V	
87	010100111	127	57	W	
88	010110000	130	58	X	
89	010110001	131	59	Y	
90	010110010	132	5A	Z	
91	010110011	133	5B	[Left Square Bracket
92	010110100	134	5C	\	Back Slash
93	010110101	135	5D]	Right Square Bracket

cont.

Decimal	Binary 7 6 5 4 3 2 1 0	Octal	Hex	ASCII Character	Control Function or Character Description
94	0 1 0 1 1 1 1 0	136	5E	^	Circumflex
95	0 1 0 1 1 1 1 1	137	5F	_	Underscore
96	0 1 1 0 0 0 0 0	140	60	‘	Left Single Quote
97	0 1 1 0 0 0 0 1	141	61	a	
98	0 1 1 0 0 0 1 0	142	62	b	
99	0 1 1 0 0 0 1 1	143	63	c	
100	0 1 1 0 0 1 0 0	144	64	d	
101	0 1 1 0 0 1 0 1	145	65	e	
102	0 1 1 0 0 1 1 0	146	66	f	
103	0 1 1 0 0 1 1 1	147	67	g	
104	0 1 1 0 1 0 0 0	150	68	h	
105	0 1 1 0 1 0 0 1	151	69	i	
106	0 1 1 0 1 0 1 0	152	6A	j	
107	0 1 1 0 1 0 1 1	153	6B	k	
108	0 1 1 0 1 1 0 0	154	6C	l	
109	0 1 1 0 1 1 0 1	155	6D	m	
110	0 1 1 0 1 1 1 0	156	6E	n	
111	0 1 1 0 1 1 1 1	157	6F	o	
112	0 1 1 1 0 0 0 0	160	70	p	
113	0 1 1 1 0 0 0 1	161	71	q	
114	0 1 1 1 0 0 1 0	162	72	r	
115	0 1 1 1 0 0 1 1	163	73	s	
116	0 1 1 1 0 1 0 0	164	74	t	
117	0 1 1 1 0 1 0 1	165	75	u	
118	0 1 1 1 0 1 1 0	166	76	v	
119	0 1 1 1 0 1 1 1	167	77	w	
120	0 1 1 1 1 0 0 0	170	78	x	
121	0 1 1 1 1 0 0 1	171	79	y	
122	0 1 1 1 1 0 1 0	172	7A	z	
123	0 1 1 1 1 0 1 1	173	7B	{	Left Curved Bracket
124	0 1 1 1 1 1 0 0	174	7C		Vertical Line
125	0 1 1 1 1 1 0 1	175	7D	}	Right Curved Bracket
126	0 1 1 1 1 1 1 0	176	7E	~	Tilde
127	0 1 1 1 1 1 1 1	177	7F	DEL	Delete (rubout)

Appendix D

Quick Reference Sheet

REMOTE COMMANDS

Command	ASCII	HEX	Command	ASCII	HEX
Autobaud	SP	20	Resolution:		
Origin:			10 lpm (254 lpi)	f	66
horizontal (961) or			20 lpm (508 lpi)	i	69
upper left (1201)	b	62	40 lpm (1016 lpi)	q	71
vertical (961) or			100 lpi	d	64
lower left (1201)	c	63	200 lpi	e	65
Report Modes:			400 lpi	g	67
Stream Mode	@	40	500 lpi	b	68
Switch Stream Mode	A	41	1000 lpi	j	6A
Point Mode	B	42	Grid Roundoff:		
Remote Request Mode			1 lpi	l	6C
mode command	D	44	2 lpi	n	6E
trigger command	P	50	4 lpi	p	70
Delta Mode	E	45	Set X, Y Scale	r	
Increment Mode			X axis low byte	not appl.	00 to FF
command	I	49	X axis high byte	not appl.	00 to FF
value	SP to z	20 to 7A	Y axis low byte	not appl.	00 to FF
Axis Update Mode			Y axis high byte	not appl.	00 to FF
command	G	47	Stop Transmission	DC3	13
value	SP to z	20 to 7A	Start Transmission	DC1	11
Report Rate:			Tablet Identifier		
max/32	T	54	zero	0	30
max/8	S	53	one	1	31
max/2	R	52	Echo	k	6B
maximum	Q	51	Code Check	x	
Send Configuration	a	61	Factory Test (don't use)	z	7A
Self Test	t	74	Reset	NUL	00
Send Test Results	w	77			

DEFAULT OPERATING CHARACTERISTICS

Resolution	500 lpi
Report Rate	maximum
Report Mode	Switch Stream
Increment	0
Axis Update	0
Origin:	
MM 961	for vertical orientation
MM 1201	lower left corner
Tablet Identifier	0

DEFAULT CONFIGURATION

Report format	8-bit packed binary, including one stop bit and parity (odd) enabled
Baud rate	9600, fixed