



# DRAWINGBOARD III™ PRINTABLE HELP FILES

## Table of Contents

<b>Introduction</b>	<b>3</b>
System Requirements & Compatibility	3
Overview	4
Drawing Area	4
Menu Strip	4
Indicator Light	4
Pointing Tools	5
<b>Getting Started</b>	<b>6</b>
Unpacking the Tablet	6
Installing the Tablet	6
Installing the Software	9
<b>Learning the Basics</b>	<b>10</b>
Using the Pointing Tools	10
Learning Basic Movements	11
<b>Customizing the Tablet</b>	<b>12</b>
Overview of the Menu Strip	12
Selecting a Pre-Programmed Setup	13
Selecting a Custom Setup	14
Tablet Options	15
Recommended Setups for Common PC Software Packages	21
Restoring a Pre-Programmed Setup	25
<b>Caring for the Tablet</b>	<b>26</b>
Cleaning the Tablet	26
Replacing the Pen Tip	27
Replacing the Pen Batteries	27
Replacing the Cursor Batteries	28
<b>Solving Problems</b>	<b>29</b>
Reducing Monitor Interference	29
Tablet Checklist	30
Computer Checklist	31



by TURNING technologies

Software Checklist	31
Troubleshooting Chart	32
Returning your Tablet for Repair	33
<b>Specifications</b>	<b>34</b>
<b>Parts and Accessories</b>	<b>36</b>
<b>Glossary</b>	<b>37</b>
<b>Regulatory Statements and Warranty</b>	<b>42</b>
Radio and Television Interference	42
Canada	42
European Union Emission Directive	43
European Union WEEE Directive	43
Japan	44
<b>CE Certification</b>	<b>44</b>
<b>Warranty for U.S./ Canada</b>	<b>45</b>



## Introduction

DrawingBoard III is a high performance, low cost digitizer designed for CAD, mapping and GIS applications as well as drawing, tracing and presentation graphics. The tablet offers high resolution and accuracy along with easy-to-use software and programmable function keys.

DrawingBoard III combines all the advantages of a mouse and digitizer to eliminate multiple input devices and provide users with a superior, simplified desktop. Choose from a wide range of options and sizes to help create a working environment suited to your application.

## System Requirements and Compatibility

DrawingBoard III is equipped with an RS-232 serial interface and is compatible with PC's and Sun workstations. Be sure the software CD you received matches the computer platform being used.

The PC software is suitable with Windows® (WinTAB compliant), ADI and Microsoft mouse. After installing the PC software, DrawingBoard III will work with virtually all DOS and Windows applications that support a digitizer or a Microsoft mouse. You must be using DOS 5.0 or later and Windows 95 or later.

The Sun software drivers are X11 compatible. You can use DrawingBoard III with or instead of the Sun mouse. The Sun drivers do not contain macro or tablet-to-screen mapping capabilities.

### ***PC Minimum Requirements***

- IBM PC AT, PS/2 or compatible computer
- 640Kb RAM
- 1 serial port
- Hard drive or network server drive
- DOS 5.0 or later or Windows 95 or later

### ***Sun Workstation Minimum Requirements***

- Sun SPARCstation
- 1 serial port
- Hard drive
- Solaris 1 or 2



## Overview

The DrawingBoard III tablet consists of:

- Drawing Area
- Menu Strip
- Indicator Light
- Pointing Tools

### **Drawing Area**

The drawing area is the rectangular surface area on the tablet located below the menu strip (see figure). This is where all your work is performed. The small format tablets (12" x 12", 12 X 18" and 18" x 24") have a clear plastic cover over the drawing area that can be used to secure artwork or templates.

### **Menu Strip**

The menu strip is the row of keys located at the top of the tablet on small format tablets and in the lower left corner of the tablet on large format tablets. You can use the keys to customize the tablet or assign macros for greater productivity.

### **Indicator Light**

There are two indicator lights within the menu strip: power and configuration. The **power light** is activated when the power is on. It also indicates whether the pointing tool is within range of the drawing area. The power light glows if the pointing tool is inside the drawing area and blinks if it is outside the drawing area of the tablet.

The **configuration light** is activated when the Config/Exit key is selected. You will also hear a beep. This means the tablet is in the configuration mode and changes can be made to the Configuration keys. The light stays on until the Config/Exit key is selected again, exiting configuration mode. A double beep sounds.

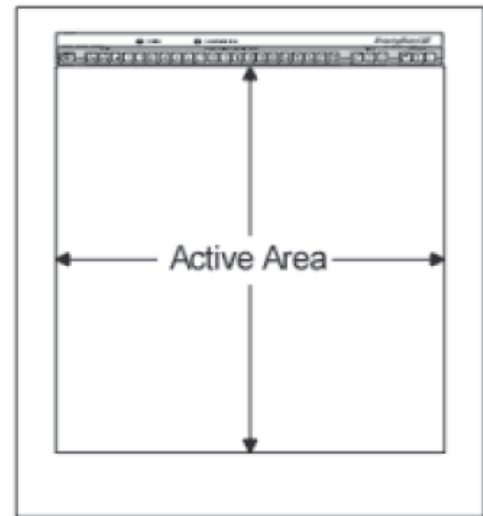



## ***Pointing Tools***

There are two types of pointing tools available with DrawingBoard III: **pens** and **cursors**.

The pointing tools are available in both corded and cordless versions. The cordless pointing tools are powered by batteries.

Each tool goes into a battery-saving "sleep mode" when no button has been pressed for one to five minutes, depending on the type of tool being used. To reactivate the tool, press any of its buttons.

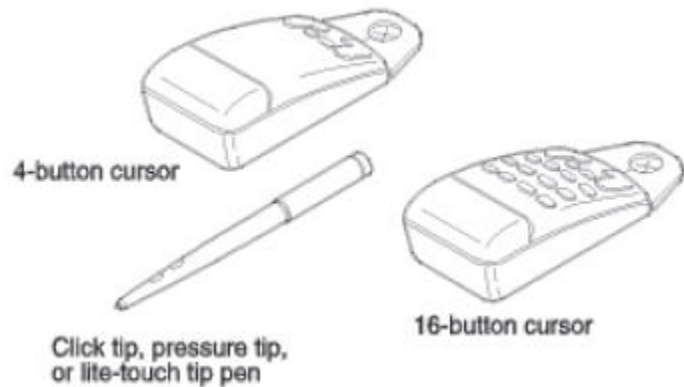

## ***Cursors***

The cursor is similar in appearance to a mouse, except that it has an attached lens with crosshairs for highly accurate detail work. Cursors are available with 4 or 16 buttons. There is a special 16-button cursor available with high accuracy tablets. The corded cursor has a lens area that can be illuminated.

## ***Pens***

The pen is identical in appearance to a ballpoint pen. It has a button built into the tip, plus two programmable side buttons on the barrel. There are three types of pens identified by a colored ring on the pen barrel:

- Click-tip pen – Light blue ring
- Pressure tip pen – Black ring
- Lite touch tip – Red ring



## Getting Started

### Unpacking the Tablet

Before you begin installation, verify that you have received:

- Pointing tool (at least one)
- Power supply
- Serial cable
- TabletWorks CD-ROM
- Registration card and Quick Start instructions
- Pen holder (if pointing tool is a pen)

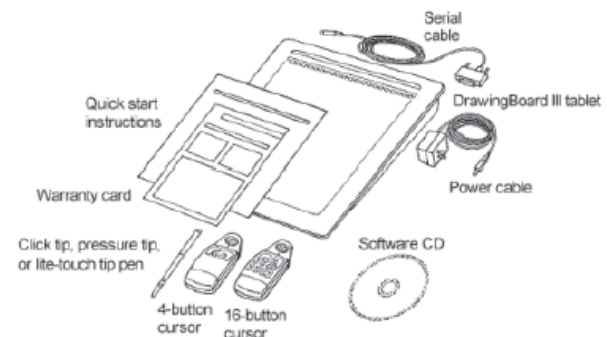

If any package contents are missing, call GTCO CalComp by Turning Technologies Customer Service at 1.866.746.3015 in the U.S. or Canada. Outside the U.S. or Canada, please contact your local GTCO CalComp by Turning Technologies office or authorized reseller.

### Installing the Tablet

All cable connections are made at the rear of the tablet. Turn off your computer and make sure the tablet power switch is in the off position.

#### 1. **Connect the serial cable.**

Attach the round end of the serial cable to the socket labeled **I/O** on the tablet. The arrow on the connector should face down.

Connect the wide end of the serial cable to the computer's serial communication port. Tighten the thumbscrews. The arrow on the connector should face down.

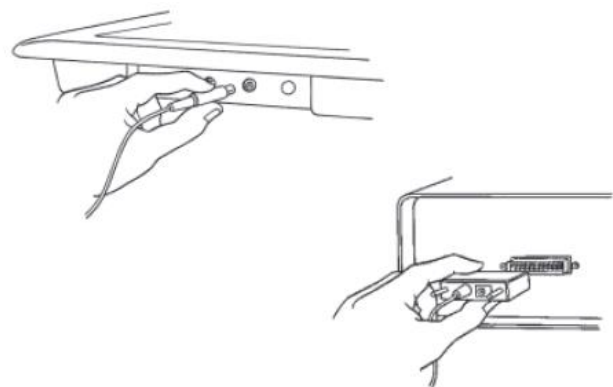



by TURNING technologies

**2. Join the power cable to the serial connector.**

Connect the power cable into the jack on the back of the serial cable connector. Attach the power supply end to a power outlet or power strip.

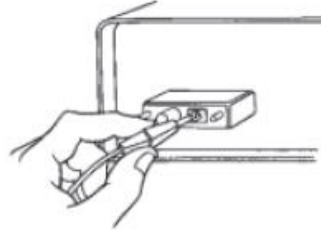

**3. Connect the corded pointing tool.**

If you are using a corded pointing tool, insert the connector into the socket labeled **POINTER** on the tablet.

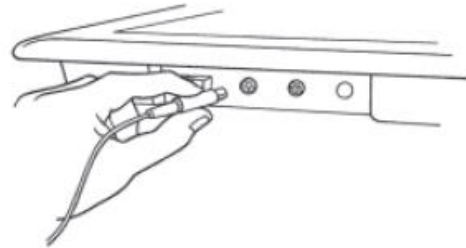

**4. Install the light bulbs (backlit tablets only).**

- a. Turn the power switch off and remove the light cover plates from the light pan below the tablet surface.
- b. Slide a bulb through the light pan opening and insert the prongs into the far socket.
- c. Insert the remaining prongs into the near socket.
- d. Twist the bulb approximately 90° until the prongs seat.
- e. After all bulbs have been installed, reinstall the light cover plates.
- f. Using the long power cord supplied, connect the power plug to a wall

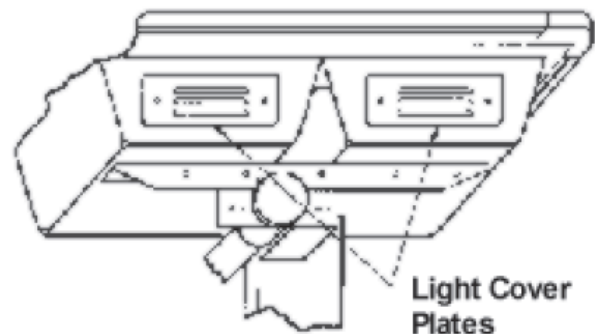



outlet and attach the free end to the light pan.

**NOTE:** Do not alter the factory-define voltage of the tablet. If your voltage requirements change, contact Technical Support at 1.866.746.3015 in the U.S. and Canada, or your local GTCO CalComp by Turning Technologies office outside the U.S. and Canada.

#### **5. Turn on the computer and tablet.**

The tablet power switch is located at the rear of the tablet on small format models. On large format models, the switch is located either 1) at the rear of the tablet or 2) on the left side, near the bottom of the tablet. The power light will turn on.

If you are using a cordless pointing tool, turn it on by pressing any button on the tool. The power light will glow steadily if the pointing tool is inside the drawing area of the tablet. If the pointing tool is outside the drawing area, the power light will blink.

#### **Backlit tablets**

The tablet and light pan power up separately. The tablet power switch is found on the lower left side of the tablet. The light pan power switch is located on the light pan below the lower right corner of the tablet.

Backlit tablets are available with a variable intensity option. This option allows you to control the brightness level of the tablet lights through a dimmer switch that is located on the light pan below the lower right corner of the tablet.

**NOTE:** Variable intensity backlit tablets are for 120V / 60Hz operation only.

#### **6. Attach the pen holder (optional).**

Pens come with a holder that you can mount to your desk, monitor or anywhere that's convenient. Remove the backing to the adhesive strip on the pen holder and firmly press the adhesive strip to any surface.





### 7. **Mount the accessory tray (optional for large format).**

The large format tablets come with an accessory tray that you can mount at any position around the tablet. To mount the accessory tray:

- a. Insert the carriage bolts provided into the three tabs on the side of the tray.
- b. Loosely attach the black knobs to the bottom of the carriage bolts.
- c. Slide the bolts into one of the grooves on the underside of the tablet.
- d. Position the tray and then tighten the knobs securely.

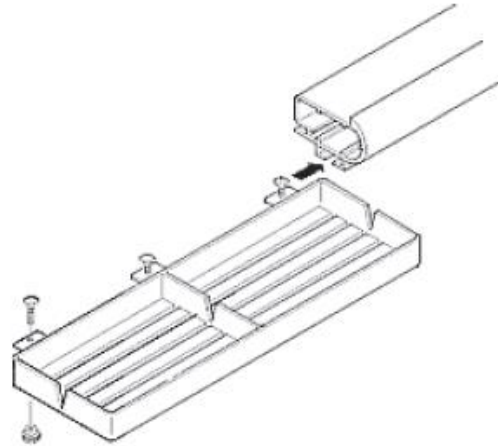

### Installing the Software

The TabletWorks software included with DrawingBoard III allows you to use your tablet both as a mouse and digitizer, and to access all tablet features and capabilities through the TabletWorks control panel. Refer to **TabletWorks Help** for instructions on installing software and for customizing the tablet.

### Special Cases

Some unique situations may not require the use of the digitizer software. Cases are rare and usually involving a non-Windows CAD application where the tablet is used solely as a digitizer with no mouse functions. In these particular settings, you can set up DrawingBoard III manually via the menu strip. Refer to the **Customizing the Tablet** section for step-by-step instructions.

All mouse applications, including all Windows applications and AutoCAD, must have the digitizer software installed to work properly with the tablet.



## Learning the Basics

### Using the Pointing Tools

The pointing tool does not need to be in contact with the tablet surface in order for the device to sense its presence. It can be detected up to 1/2" above the drawing area. This allows you to trace through materials placed on the surface, such as a drawing or book. Also, before using the pointing tool, be sure that sleep mode is turned off by pressing any button on the tool.

### Using the Cursor

When using the cursor, the intersection point of the crosshairs on the lens identifies the point that's selected. The crosshairs are etched on the bottom of the lens to increase accuracy. For maximum precision, look through the lens from directly over it.



Button 0 on the cursor is used as the pick (or left mouse) button. All other buttons are defined by the TabletWorks software or through your own software application.

### High Accuracy Cursor

To illuminate the lens area of the high accuracy cursor, press and hold any button in the far right column (3, 7, B or F); at the same time, press and hold any button in the far left column (0, 4, 8 or C). The right column button must be held down while pressing the left column button. This same procedure turns the illumination off. The illumination defaults to off when the tablet is first powered on.

Because you will always need one right column button and one left column button free to control the cursor illumination, you should reserve one button in each column from any macro recording.

**NOTE:** DrawingBoard III high accuracy cursor resembles the cursor for the 9500 series tablet. Although the only difference seems to be the presence of the row of LEDs above the top row of buttons on the 9500 series cursors, **do not interchange these cursors** as damage to both tablet and cursor may result.



## Using the Pen

There are three variations of pens: click tip, pressure tip and the lite-touch tip. All the variations are tilt and height sensitive. The pen tip is Button 0 and is used as the pick (or left mouse) button. The lower side button is Button 1 and the upper side button is Button 2.

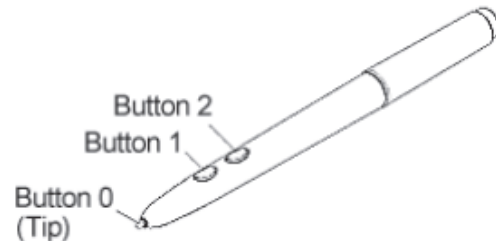

The functions these buttons provide are defined through the TabletWorks software or through your own software application.

**Click Tip Pen:** Available in both corded and cordless versions. It is primarily used for tracing and menu picking. To use the pen, press down until you feel the tip click.

**Pressure-Tip Pen:** Only available in the cordless version. With the pressure pen, the pen tip can be used both as a mouse button and a pressure-sensitive button. To take advantage of the pressure feature, the software package you use must recognize pressure sensitivity. The software assigns values to the pressure levels and uses this data to vary such parameters as line width and color.

To use the pen, press down on the tip and release for a mouse pick action. Press down and hold for the pressure action. Pressure increases as you continue pressing down on the tip. To decrease the pressure, ease up on the tip.

## Learning Basic Movements

The DrawingBoard III pointing tools provide all the basic movements of a mouse. The basic movements are clicking, double-clicking and dragging.

### Clicking and Double-Clicking

Clicking is the action of making a selection. You may be selecting a key on the tablet surface or making a selection from the monitor screen. To click, place the pointing tool or move the screen pointer via the pointing tool, to the item to be selected. Tap the pen or press Button 0 on the cursor. A double-click requires you to tap the pen or press the button quickly two times while the tool remains in the same place. You can also double-click by pressing the pen or cursor button that has been defined as a double-click button (see **TabletWorks Help**).



## Dragging

Dragging is the action of moving the pointing tool during a selection. To drag, click on an object, but instead of releasing the tip or button, hold it down while moving the pointing tool or corresponding object on the screen, to the desired new location.

## Customizing the Tablet

Customize the DrawingBoard III tablet and pointing tool to suit your individual work requirements using TabletWorks. The Windows program is included with the digitizer software and helps you experience the full capabilities of your tablet. You can map your device to the screen area, record your own macros and designate areas on the tablet to switch between open software applications. To learn how to use TabletWorks, please refer to **TabletWorks Help**.

### Overview of the Menu Strip



The Menu Strip is composed of:

- **Config/Exit key**  
The Config/Exit key turns configuration mode on and off.
- **3 Bank keys**  
There are three Bank keys: A, B and C. Each bank has a different set of tablet options that are available through Configuration key combinations.
- **18 Configuration keys**  
The keys numbered 1-18 can be used as both Configuration and Macro keys. When the tablet is in configuration mode, they function as Configuration keys. These keys allow you to set specific tablet options by turning different combinations of Configuration keys ON or OFF.

When configuration mode is off, the keys function as Macro keys. Macros can only be recorded with TabletWorks software (see **TabletWorks** manual).



### ▪ 3 Save and 3 Restore keys

The Save and Restore keys work hand-in-hand. They are used to save (or recall) a setup to (or from) one of three save areas. There are three pre-programmed setups that come with the tablet. You can use these setups directly or overwrite them with your own. The Default Save key controls the first save area. The setup saved to this area is activated whenever you power up the tablet. It's recommended to save the setup used most often as *Default*.

### **Selecting a Pre-Programmed Setup**

There are three pre-programmed setups available with DrawingBoard III:

- GTCO CalComp by Turning Technologies DP5 High Resolution Binary
- Summagraphics MM 1201
- CalComp 2000 ASCII

These setups are commonly used within software applications as required tablet formats. They are stored in save areas *Default*, *2* and *3*, respectively. Check the manual that came with your software package to see if your application requires one of these pre-programmed setups. The *Default* setup is available when you power on the digitizer.

### **To select one of the other setups:**



1. Turn on Configuration Mode by clicking on the **Config/Exit** key. The configuration light will turn on and remain activated while the tablet is in configuration mode.



2. Click on the desired **Restore** key.



3. Click on the **Config/Exit** key again to exit Configuration Mode. The new setup is activated.



by TURNING technologies

The following table lists the tablet options used by the pre-programmed setups.

	<b>Default</b>	<b>Save 2</b>	<b>Save 3</b>
<b>Mode</b>	Run	Track	Point
<b>Baud Rate</b>	9600	9600	9600
<b>Data Bits</b>	8	8	7
<b>Parity</b>	None	Odd	Even
<b>Data Rate</b>	125 pps	150 pps	125 pps
<b>Resolution</b>	1000 lpi	500 lpi	200 lpi
<b>Output Format</b>	Format 23	Format 30	Format 0
<b>Emulation</b>	GTCO TTech DP5 High Resolution Binary	Summagraphics MM 1201 Binary	CalComp 2000 ASCII

### ***Selecting a Custom Setup***

You can setup specific tablet options by turning different combinations of Configuration keys ON or OFF. The available tablet options are listed below.

#### ***To set up the tablet:***



1. Turn on Configuration Mode by clicking on the **Config/Exit** key. The configuration light will turn on and remain activated while the tablet is in configuration mode.



2. Click on the **Bank** key where you need to work (A, B or C). You can determine which bank you are in by placing the pointing tool over one of the bank keys. The power light is on if the bank is active.



3. Determine whether the **Configuration** keys are ON or OFF by placing the pointing tool over each key. If the key is ON, the power light is ON; if the key is off, the power light is off. If necessary, click on the key to toggle the setting.



by TURNING technologies

4. Repeat steps 2 and 3 for the remaining banks as required.



5. After you have completed your setup, save it by clicking on one of the **Save** keys.



Clicking on a Save key will overwrite the pre-programmed setup. This step may be omitted if the setup is *temporary* for the current session, but the setup will be lost when the tablet is powered off. Only save your setup when you will need it for repeated work sessions.

When you overwrite a pre-programmed setup, see the *Restoring a Pre-Programmed Setup* section for information on restoring the original settings.



6. Exit Configuration Mode by clicking on the **Config/Exit** key.

**Tablet Options**

The following sections show the various tablet options available through Configuration keys on the Menu Strip. Follow the procedure above, using the keys shown for the option. The circles represent the Indicator light on the tablet:

= Power Light ON

= Power Light OFF

**Defining operating mode**

Line				
Point				
Track				
Run				

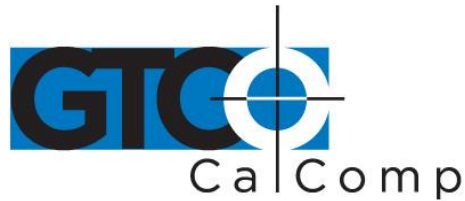

by TURNING technologies

**Setting up increment mode**

	<b>Config Exit</b>	<b>A 1-18</b>	<b>3</b>	<b>4</b>
None			<input type="radio"/>	<input type="radio"/>
1			<input type="radio"/>	<input checked="" type="radio"/>
5			<input checked="" type="radio"/>	<input type="radio"/>
10			<input checked="" type="radio"/>	<input checked="" type="radio"/>

**Turning on prompt mode**

	<b>Config Exit</b>	<b>A 1-18</b>	<b>5</b>
On			<input checked="" type="radio"/>
Off			<input type="radio"/>

**Setting up data rate for CalComp 2000 format**

	<b>Config Exit</b>	<b>A 1-18</b>	<b>6</b>	<b>7</b>	<b>8</b>
1 pps			<input type="radio"/>	<input type="radio"/>	<input type="radio"/>
5 pps			<input type="radio"/>	<input type="radio"/>	<input checked="" type="radio"/>
10 pps			<input type="radio"/>	<input checked="" type="radio"/>	<input type="radio"/>
20 pps			<input type="radio"/>	<input checked="" type="radio"/>	<input checked="" type="radio"/>
40 pps			<input checked="" type="radio"/>	<input type="radio"/>	<input type="radio"/>
75 pps			<input checked="" type="radio"/>	<input type="radio"/>	<input checked="" type="radio"/>
100 pps			<input checked="" type="radio"/>	<input checked="" type="radio"/>	<input type="radio"/>
125 pps			<input checked="" type="radio"/>	<input checked="" type="radio"/>	<input checked="" type="radio"/>

**Setting up data rate for Summagraphics MM ASCII format**

	<b>Config Exit</b>	<b>A 1-18</b>	<b>6</b>	<b>7</b>	<b>8</b>
7 pps			<input type="radio"/>	<input checked="" type="radio"/>	<input checked="" type="radio"/>
20 pps			<input type="radio"/>	<input checked="" type="radio"/>	<input type="radio"/>
50 pps			<input type="radio"/>	<input type="radio"/>	<input checked="" type="radio"/>
100 pps			<input type="radio"/>	<input type="radio"/>	<input type="radio"/>





**Setting up data rate for Summagraphics  
MM binary format**

	<b>Config Exit</b>	<b>A 1-18</b>	<b>6</b>	<b>7</b>	<b>8</b>
7 pps	<input type="radio"/>	<input checked="" type="radio"/>	<input checked="" type="radio"/>	<input checked="" type="radio"/>	<input checked="" type="radio"/>
25 pps	<input type="radio"/>	<input checked="" type="radio"/>	<input checked="" type="radio"/>	<input type="radio"/>	<input type="radio"/>
75 pps	<input type="radio"/>	<input type="radio"/>	<input type="radio"/>	<input checked="" type="radio"/>	<input checked="" type="radio"/>
150 pps	<input type="radio"/>	<input type="radio"/>	<input type="radio"/>	<input type="radio"/>	<input type="radio"/>

**Setting up resolution**

Resolutions up to 10,000 lpi are available on the large format, high-accuracy tablets for applications that support it.

	<b>Config Exit</b>	<b>A 1-18</b>	<b>9</b>	<b>10</b>	<b>11</b>
200 lpi	<input type="radio"/>	<input type="radio"/>	<input type="radio"/>	<input type="radio"/>	<input checked="" type="radio"/>
254 lpi (10 lpmm)	<input type="radio"/>	<input checked="" type="radio"/>	<input type="radio"/>	<input type="radio"/>	<input type="radio"/>
400 lpi	<input type="radio"/>	<input checked="" type="radio"/>	<input checked="" type="radio"/>	<input checked="" type="radio"/>	<input type="radio"/>
500 lpi	<input checked="" type="radio"/>	<input type="radio"/>	<input type="radio"/>	<input type="radio"/>	<input type="radio"/>
508 lpi (20 lpmm)	<input checked="" type="radio"/>	<input type="radio"/>	<input type="radio"/>	<input checked="" type="radio"/>	<input checked="" type="radio"/>
1000 lpi	<input checked="" type="radio"/>	<input checked="" type="radio"/>	<input type="radio"/>	<input type="radio"/>	<input type="radio"/>
1270 lpi (50 lpmm)	<input checked="" type="radio"/>	<input checked="" type="radio"/>	<input checked="" type="radio"/>	<input checked="" type="radio"/>	<input checked="" type="radio"/>
2540 lpi (100 lpmm)	<input type="radio"/>	<input type="radio"/>	<input type="radio"/>	<input type="radio"/>	<input type="radio"/>

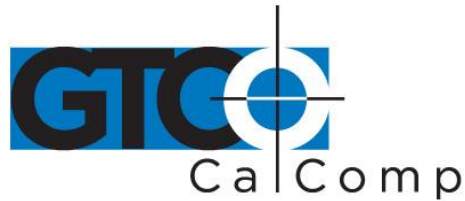

by TURNING technologies

**Setting up format**

	Config Exit	A 1-18	12	13	14	15	16
0-CalComp 2000 A			<input type="radio"/>	<input type="radio"/>	<input type="radio"/>	<input type="radio"/>	<input type="radio"/>
1-CalComp Wedge			<input type="radio"/>	<input type="radio"/>	<input type="radio"/>	<input type="radio"/>	<input checked="" type="radio"/>
2-Summa ID ASCII			<input type="radio"/>	<input type="radio"/>	<input type="radio"/>	<input checked="" type="radio"/>	<input type="radio"/>
3-Summa MM 1201 A			<input type="radio"/>	<input type="radio"/>	<input type="radio"/>	<input checked="" type="radio"/>	<input checked="" type="radio"/>
4-CalComp 9100-1			<input type="radio"/>	<input type="radio"/>	<input checked="" type="radio"/>	<input type="radio"/>	<input type="radio"/>
5-CalComp 9100-2			<input type="radio"/>	<input type="radio"/>	<input checked="" type="radio"/>	<input type="radio"/>	<input checked="" type="radio"/>
6-CalComp 9100-3			<input type="radio"/>	<input type="radio"/>	<input checked="" type="radio"/>	<input checked="" type="radio"/>	<input type="radio"/>
7-CalComp 9100-4			<input type="radio"/>	<input type="radio"/>	<input checked="" type="radio"/>	<input checked="" type="radio"/>	<input checked="" type="radio"/>
8-Summa MM 1105 A			<input type="radio"/>	<input checked="" type="radio"/>	<input type="radio"/>	<input type="radio"/>	<input type="radio"/>
9-GTCO DP5 ASCII			<input type="radio"/>	<input checked="" type="radio"/>	<input type="radio"/>	<input type="radio"/>	<input checked="" type="radio"/>
10-GTCO DP5 ASCII			<input type="radio"/>	<input type="radio"/>	<input type="radio"/>	<input checked="" type="radio"/>	<input type="radio"/>
11-GTCO MD7 ASCII			<input type="radio"/>	<input checked="" type="radio"/>	<input type="radio"/>	<input checked="" type="radio"/>	<input checked="" type="radio"/>
12-Hitachi ASCII			<input type="radio"/>	<input checked="" type="radio"/>	<input checked="" type="radio"/>	<input type="radio"/>	<input type="radio"/>
13-HiPad ASCII			<input type="radio"/>	<input checked="" type="radio"/>	<input checked="" type="radio"/>	<input type="radio"/>	<input checked="" type="radio"/>
14-Hitachi ASCII Sign			<input type="radio"/>	<input checked="" type="radio"/>	<input checked="" type="radio"/>	<input checked="" type="radio"/>	<input type="radio"/>
15-Summa MM 1105 A			<input type="radio"/>	<input checked="" type="radio"/>	<input checked="" type="radio"/>	<input checked="" type="radio"/>	<input checked="" type="radio"/>
16-Summa MM 1105 A			<input checked="" type="radio"/>	<input type="radio"/>	<input type="radio"/>	<input type="radio"/>	<input type="radio"/>
17-Wacom ASCII			<input checked="" type="radio"/>	<input type="radio"/>	<input type="radio"/>	<input type="radio"/>	<input checked="" type="radio"/>
18-Reserved			<input checked="" type="radio"/>	<input type="radio"/>	<input type="radio"/>	<input checked="" type="radio"/>	<input type="radio"/>
19-Reserved			<input checked="" type="radio"/>	<input type="radio"/>	<input type="radio"/>	<input checked="" type="radio"/>	<input checked="" type="radio"/>
20-CalComp AFT			<input checked="" type="radio"/>	<input type="radio"/>	<input checked="" type="radio"/>	<input type="radio"/>	<input type="radio"/>
21-Wacom Binary			<input checked="" type="radio"/>	<input type="radio"/>	<input checked="" type="radio"/>	<input type="radio"/>	<input checked="" type="radio"/>
22-CalComp Fmt 22			<input checked="" type="radio"/>	<input type="radio"/>	<input type="radio"/>	<input checked="" type="radio"/>	<input type="radio"/>
23-CalComp Hi Res			<input checked="" type="radio"/>	<input type="radio"/>	<input checked="" type="radio"/>	<input checked="" type="radio"/>	<input checked="" type="radio"/>
24-GTCO DP5 Hi Res			<input checked="" type="radio"/>	<input checked="" type="radio"/>	<input type="radio"/>	<input type="radio"/>	<input type="radio"/>
25-GTCO Lo Res Bin			<input checked="" type="radio"/>	<input checked="" type="radio"/>	<input type="radio"/>	<input type="radio"/>	<input checked="" type="radio"/>
26-Kurta Serial 1 #3			<input checked="" type="radio"/>	<input checked="" type="radio"/>	<input type="radio"/>	<input checked="" type="radio"/>	<input type="radio"/>
27-Hitachi Hi Res			<input checked="" type="radio"/>	<input checked="" type="radio"/>	<input type="radio"/>	<input checked="" type="radio"/>	<input checked="" type="radio"/>
28-CalComp 2000 Bin			<input checked="" type="radio"/>	<input checked="" type="radio"/>	<input checked="" type="radio"/>	<input type="radio"/>	<input type="radio"/>
29-Summa MM 1201 B3			<input checked="" type="radio"/>	<input checked="" type="radio"/>	<input checked="" type="radio"/>	<input type="radio"/>	<input checked="" type="radio"/>
30-Summa MM 1201 B			<input checked="" type="radio"/>	<input checked="" type="radio"/>	<input checked="" type="radio"/>	<input checked="" type="radio"/>	<input type="radio"/>
31-MicroGrid II Binary			<input checked="" type="radio"/>	<input checked="" type="radio"/>	<input checked="" type="radio"/>	<input checked="" type="radio"/>	<input checked="" type="radio"/>

**Adding line feed**

Config Exit	A 1-18	17
None		<input type="radio"/>
Add		<input checked="" type="radio"/>

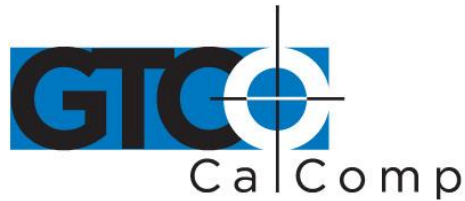

by TURNING technologies

**Setting up data/stop bits**

Config Exit A 1-18 18

7

8

**Setting up baud rate**

Config Exit B 1-18 1 2 3

19200

9600

4800

2400

1200

**Setting up parity**

Config Exit B 1-18 4 5 6

None

Mark

Space

Even

Odd

**Setting corded frequency**

Config Exit B 1-18 7

Low

High

**Using Summagraphics MM or CalComp 2000 commands**

Config Exit B 1-18 8

Use commands

Do not use

**Using ESC for 9X00 commands**

Config Exit B 1-18 9

Do not use ESC

Must use escape

**Sending data out of proximity**

Config Exit B 1-18 10

No data out of prox

Send data



by TURNING technologies

**Turning on pressure pen data**

Config Exit B 1-18 **11**

Off

On

**Turning on pen height data**

Config Exit B 1-18 **12**

Off

On

**Turning on pen tilt data**

Config Exit B 1-18 **13**

Off

On

**Turning on pen tilt correction**

Config Exit B 1-18 **14**

Off

On

**Changing tablet to mouse mode**

Config Exit B 1-18 **15** **16**

No mouse

Mouse Systems

Microsoft

**Setting proximity**

Config Exit B 1-18 **17**

High

Low

**Setting up CTS line enable**

Config Exit B 1-18 **18**

Off

On

**Rotating the tablet**

Config Exit C 1-18 **1** **6**

0°

90°

180°

270°

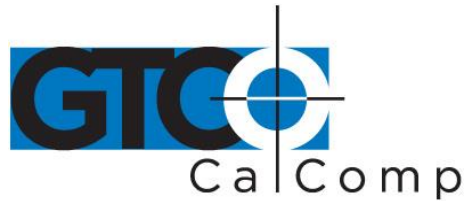

by TURNING technologies

### Removing CR on ASCII formats



### Controlling pen sound



### Controlling tablet speaker



### Changing tilt data to pressure data



### Using the high accuracy cursor with a small format tablet



### ***Recommended Setups for Common PC Software Packages***

The following sections show the **Configuration** key setups for some common PC software packages. Set up the Configuration keys as shown below (see ***Selecting a Custom Setup***). The circles represent the power light on the tablet. Bank C does not vary for these packages so it is not included in the description.



by TURNING technologies

● = Power Light ON

○ = Power Light OFF

### Setting up for ARCINFO

Using CalComp 9100 format:

Config Exit	1	2	3	4	5	6	7	8	9	10	11	12	13	14	15	16	17	18
A 1-18	○	●	○	○	○	●	●	●	●	○	○	○	●	●	○	○	●	○
B 1-18	○	○	●	●	○	○	○	○	○	○	○	○	○	○	○	○	○	●

Using GTCO DigiPad format:

Config Exit	1	2	3	4	5	6	7	8	9	10	11	12	13	14	15	16	17	18
A 1-18	●	●	○	○	○	●	●	●	●	○	●	○	●	●	○	○	●	○
B 1-18	○	○	●	●	○	○	○	○	○	○	○	○	○	○	○	○	○	●

### Setting up for AutoCAD (DOS only)

Using ADI format:

Config Exit	1	2	3	4	5	6	7	8	9	10	11	12	13	14	15	16	17	18
A 1-18	●	●	○	○	○	●	●	●	●	○	●	○	●	●	●	○	●	○
B 1-18	○	○	●	●	○	○	○	○	○	○	○	○	○	○	○	○	○	●

Using CalComp 9100 format:

Config Exit	1	2	3	4	5	6	7	8	9	10	11	12	13	14	15	16	17	18
A 1-18	●	●	○	○	○	●	●	●	●	○	○	○	○	●	○	○	○	○
B 1-18	○	○	●	○	○	●	○	○	○	○	○	○	○	○	○	○	○	●



### Setting up for CADKey

Using GTCO DP5 format:

Config Exit	1	2	3	4	5	6	7	8	9	10	11	12	13	14	15	16	17	18
A 1-18	●	●	○	○	○	●	●	●	●	○	●	○	●	●	●	○	●	●
B 1-18	○	○	●	●	○	○	○	○	○	●	●	○	○	○	○	○	○	○

Using Summagraphics MM 1201 format:

Config Exit	1	2	3	4	5	6	7	8	9	10	11	12	13	14	15	16	17	18
A 1-18	●	○	○	○	○	○	○	●	●	○	○	●	●	●	●	○	○	●
B 1-18	○	○	●	○	○	○	○	○	○	○	○	○	○	○	○	○	○	●

### Setting up for DesignCAD 2-D/3-D (DOS only)

Using GTCO DP5 format:

Config Exit	1	2	3	4	5	6	7	8	9	10	11	12	13	14	15	16	17	18
A 1-18	●	●	○	○	○	●	●	●	●	○	●	○	●	●	●	○	●	●
B 1-18	○	○	●	●	○	○	○	○	○	○	○	○	○	○	○	○	○	○

### Setting up for GeneriCAD

Using CalComp 9100 format:

Config Exit	1	2	3	4	5	6	7	8	9	10	11	12	13	14	15	16	17	18
A 1-18	●	●	○	○	○	●	●	●	●	○	○	○	○	●	●	○	○	○
B 1-18	○	○	●	○	○	●	○	○	○	○	○	○	○	○	○	○	○	●

Using GTCO DigiPad format:

Config Exit	1	2	3	4	5	6	7	8	9	10	11	12	13	14	15	16	17	18
A 1-18	●	●	○	○	○	●	●	●	●	○	●	○	●	●	●	○	●	●
B 1-18	○	○	●	●	○	○	○	○	○	○	○	○	○	○	○	○	○	●



Using Summagraphics format:

Config Exit	1	2	3	4	5	6	7	8	9	10	11	12	13	14	15	16	17	18
A 1-18	●	○	○	○	○	○	○	●	●	○	○	●	●	●	●	○	○	●
B 1-18	○	○	●	○	○	○	○	○	○	○	○	○	○	○	○	○	○	●

Setting up for MapInfo (DOS only)

Using CalComp 9100 format:

Config Exit	1	2	3	4	5	6	7	8	9	10	11	12	13	14	15	16	17	18
A 1-18	●	●	○	○	○	●	●	●	●	○	○	○	○	●	●	○	●	●
B 1-18	○	○	●	●	○	○	○	○	○	○	○	○	○	○	○	○	○	●

Using CalComp 2000 binary format:

Config Exit	1	2	3	4	5	6	7	8	9	10	11	12	13	14	15	16	17	18
A 1-18	●	●	○	○	○	●	●	●	●	○	○	○	○	●	●	●	○	●
B 1-18	○	○	●	●	○	○	○	○	○	○	○	○	○	○	○	○	○	●

Setting up for MicroStation (DOS only)

Using CalComp 9100 format:

Config Exit	1	2	3	4	5	6	7	8	9	10	11	12	13	14	15	16	17	18
A 1-18	●	●	○	○	○	●	●	●	●	○	○	○	○	●	○	●	○	●
B 1-18	○	○	●	●	○	○	○	○	○	○	○	○	○	○	○	○	○	●

Setting up for Timberline

Using CalComp 9100 format:

Config Exit	1	2	3	4	5	6	7	8	9	10	11	12	13	14	15	16	17	18
A 1-18	○	●	○	○	○	●	●	●	●	○	○	○	○	●	●	○	○	●
B 1-18	○	●	●	●	○	○	○	○	○	○	○	○	○	○	○	○	○	●



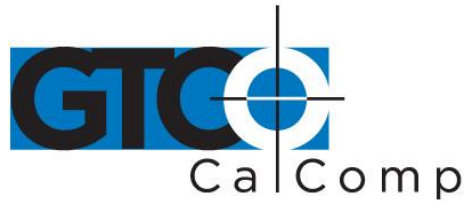

by TURNING technologies

Using Summagraphics MM 1201 binary format:



### Setting up for VersaCAD

Using CalComp 9100 format:



### Restoring a Pre-Programmed Setup

When you save a custom setup to one of the save areas, the pre-programmed setup will be overwritten. To restore the original setup, set the Configuration keys as shown below, using the procedure on the following page. The circles represent the power light on the tablet. Bank C does not vary for these applications so it is not included in the description.

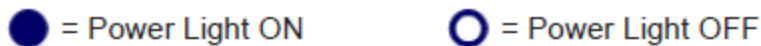

### Restoring Save Default — GTCO DP5 High Resolution



### Restoring Save 2 — Summagraphics MM 1201 binary





### Restoring Save Default — GTCO DP5 High Resolution

Config Exit	1	2	3	4	5	6	7	8	9	10	11	12	13	14	15	16	17	18	
A 1-18	○	●	○	○	○	●	●	●	○	○	●	○	○	○	○	○	○	●	○
B 1-18	○	○	●	○	○	●	○	○	○	○	○	○	○	○	○	○	○	○	○

### Caring for the Tablet

Follow these precautions at all times to avoid damaging your DrawingBoard III:

- Avoid discharging static electricity to the tablet.
- Do not place heavy objects on the tablet surface.
- Do not use sharp objects, such as compasses or knives, on the tablet surface.
- Do not use the tablet surface for any purpose other than drawing, tracing or digitizing.

### Cleaning the Tablet

To clean the tablet's surface, use a soft, non-abrasive cloth. Hardened dirt may be removed with a slightly dampened cloth. Do not clean pencil lines with a soft cleanser or pencil eraser. This may create an undesirable shiny spot on the tablet's surface that cannot be removed.



**Do not use abrasive cleaners, acrylic, or lacquer paint thinners – or cleansers with an acetone or solvent base, such as MDC or EDC – on the tablet surface. They will damage the tablet case.**



### **Replacing the Pen Tip**

To replace the pen tip, grasp the tip and pull straight out (see figure). Insert the new tip and press until it clicks into place.



### **Replacing the Pen Batteries**

The pens require two 393 silver oxide batteries. The average battery life is 750 to 1,000 hours.



**Do not use ZINC AIR batteries as replacement batteries. They will corrode the electronics of the pen.**

### **To replace the batteries:**

1. Unscrew the pen cap. Hold the pen from the bottom and gently slide off the pen cover to expose the batteries.
2. Remove the old batteries by turning the pen over and gently tapping it, letting the batteries fall into your other hand.
3. Insert the new batteries as they are shown in the figure above (+ towards pen tip).
4. Replace the pen cover and screw the pen cap onto the pen.

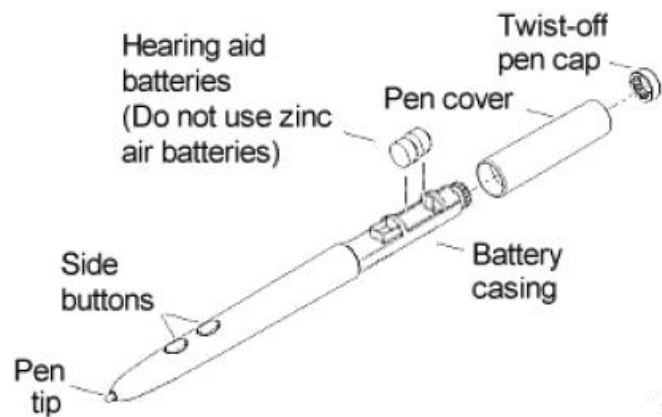



by TURNING technologies

**NOTE:** When you replace the pen batteries, the pen will reset to the default frequency. If you changed the frequency of the pen before replacing the batteries, you will need to do so again after replacing the batteries (see the **Reducing Monitor Interference** section in **Solving Problems**).

### **Replacing the Cursor Batteries**

The cordless cursor requires two AAA batteries. The average battery life for the cursor batteries is 4,000 hours.

#### **To replace the batteries:**

1. Place the cursor face down in the palm of your hand. Use a Phillips screwdriver to remove the two screws located on the bottom of the cursor (see figure). Remove the cursor base.
2. Remove the old batteries from the battery casings.
3. Place the new batteries in the casings, matching the polarity of each battery with the markings on the connector strips (match + to +).
4. Reposition the cursor base. Replace the screws with the Phillips screwdriver.

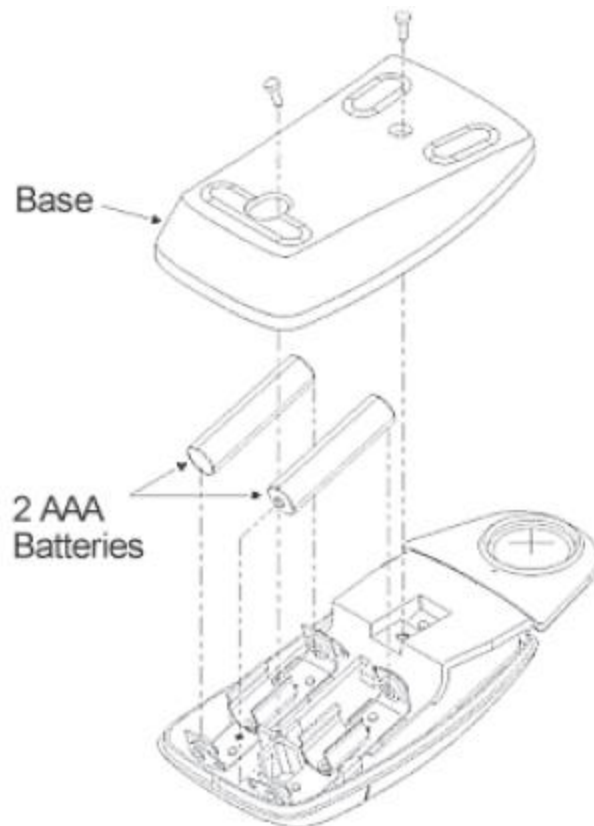

**NOTE:** When you replace the cursor batteries, the cursor will reset to the default frequency. If you changed the frequency of the cursor before replacing the batteries, you will need to do so again after replacing the batteries (see the **Reducing Monitor Interference** section in **Solving Problems**).



## Solving Problems

GTCO CalComp by Turning Technologies wants your experience with DrawingBoard III to be a successful one. If you ever encounter a problem, please follow the steps below.

1. Review this *User's Guide* to verify you have performed the correct steps.
2. Read the topics below to check for a solution to your problem. Assess the checklists, as well as the Troubleshooting Chart. Keep in mind that the problem could be your computer, display or software, instead of the digitizer.
3. If you still experience an issue, call GTCO CalComp by Turning Technologies Technical Support at 1-866-746-3015 (in the U.S. or Canada) or email us at [gtdco.support@gtdcocalcomp.com](mailto:gtdco.support@gtdcocalcomp.com). Outside the U.S. or Canada, contact your local GTCO CalComp by Turning Technologies office or dealer. Please have the following information available when you call:
  - Description of the problem
  - Name and version of software package
  - Type of computer being used
  - DrawingBoard III model and serial number (see bottom of tablet)
  - Type of pointing tool that's being used
4. Be at your computer when you call.

### ***Reducing Monitor Interference***

If you are experiencing monitor interference with your tablet, you can reduce the interference by changing the frequency your tool uses. Pointing tools with the following FCC ID numbers support two frequencies: ECPPPP, ECPPP2, ECPPLTP, ECPPCURSOR4, ECPPCURSOR16 and ESPPCURSORII. Pointing tools with FCC ID numbers other than those listed must have frequencies changed by GTCO CalComp by Turning Technologies.

### ***Changing the Frequency of the Cordless Cursor***

1. Place the cursor on the tablet surface.
2. Press Buttons 1 and 2 simultaneously and hold for approximately three seconds.
3. The cursor turns itself off. You will know the cursor is off when the power light on the tablet begins blinking.



4. The cursor turns on again at the new frequency. You will know the cursor is on when the power light glows steadily.

To return to the default frequency, repeat the above process. When you replace the cursor batteries, the cursor is automatically reset to the default frequency.

### ***Changing the Frequency of the Cordless Pen***

Press both side buttons and the tip simultaneously and hold for approximately three seconds.

To return to the default frequency, repeat the above process. When you replace the pen batteries, the pen resets to the default frequency.

### ***Changing the Frequency of a Corded Pointing Tool***

You must use the menu strip to change the frequency of the corded pointing tools (see the **Setting corded frequency** option in the **Tablet Options** section).

### ***Tablet Checklist***

- Is the tablet power supply plugged into the serial connector and into a live outlet?
- Is the tablet power switch on?
- Does the power light glow steadily when the pointing tool is inside the drawing area? Does it blink when the pointing tool is outside the drawing area?
- The power light will blink if the pointing tool has gone into sleep mode. Press any button on the tool to activate it. If the power light continues to blink and the pointing tool is in the drawing area, change the pointing tool's battery.
- Are all cable connections tight?
- Power cable to serial connector?
- Pointer cable to tablet?
- Serial cable to tablet?
- Serial cable to computer? Check that the cable is connected to the serial port specified in your software package.
- Is the tablet set up according to the software recommendations?
- Are any of the connector cables or receptacles damaged? Check for bent pins, cut insulation and loose wires.



### ***Computer Checklist***

- Is the computer plugged into a live outlet? Did you turn on the computer?
- Does the computer work with any of your software? Try one of your other programs. If the computer has a diagnostic diskette, use it.
- Is your software package installed correctly?
- Does the serial port work? The only way to test the port without special equipment is to reinstall something that has worked in the past and test if it still operates.
- Have there been any recent electrical storms in your area that may have damaged your equipment?

### ***Software Checklist***

Does the tablet work with some software?

If your tablet currently works with some software packages, you know that the tablet, USB or serial port and computer work.

- Even if the software package you are trying to install and the software that is working both support the same tablets, it does not always mean that you can use the same tablet settings. The output format may be the same, but the communications protocol, resolution, operating mode and data rate may be different. Check your software's requirements.
- Call the software manufacturer. Perhaps the software package has a problem with another component of your system.

### ***Did the software work in the past?***

If the software package worked with the tablet in the past, then the problem lies with the new setup.

- Check all the connectors. Is the tablet still plugged into the same port? If yes, reset the tablet by unplugging and re-plugging the power supply and restart the software.
- Did you reset or power down the computer?
- During reset and power on the computer can send meaningless characters out the serial port and this can disable the tablet. Reset the tablet again.
- Have you installed any new software or hardware? Remove it from your system and see if the problem goes away.
- Did you move any cables?
- If you are using a PC, did the new software alter your AUTOEXEC.BAT file?



by TURNING technologies

- Have you updated the software or its drivers?
- Are you loading another mouse driver, or do you have multiple mouse drivers?
- Did you reinstall the software, perhaps after a problem with your hard drive?  
Double check your installation procedure and the driver you selected.
- Reinstall the software from its master diskettes. The program files may have been corrupted.

### ***Troubleshooting Chart***

The following tablet lists common DrawingBoard IV problems, their causes and their solutions.

<b>Problem</b>	<b>Cause</b>	<b>Solution</b>
<b>Frozen screen pointer</b>	Pointing tool is in Sleep Mode.	Press any button on the tool.
	Menu strip is in Configuration Mode.	If the configuration light is on, click on the <b>Config/Exit</b> key on the Menu Strip.
	Tablet plugged into the wrong serial port on the computer.	Is the serial port being used correctly identified in your software application?
	Tablet not powered correctly.	Check that the power cable is installed correctly.
	Batteries low in pointing tool.	Replace the batteries in the pointing tool.
	Software application set up incorrectly.	Check that the tablet is identified in your software application.



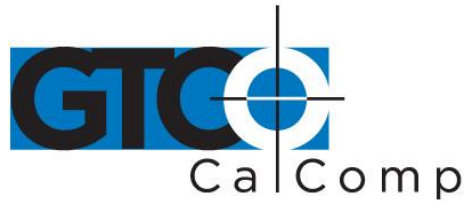

by TURNING technologies

	<p>Another device is connected to a COM port that shares the same IRQ as the tablet COM port (<i>i.e.</i>, your tablet is connected to COM1 IRQ4 and your modem is connected to COM3 IRQ4).</p>	<p>Move one of the devices to another COM port. Contact your system manufacturer for assistance in relocating the device.</p>
<p><b>Screen pointer appears to shake or jitter</b></p>	<p>Tablet is set too close to the screen monitor.</p> <p>Tablet's frequency setting may conflict with the display.</p>	<p>Move the tablet farther away from the screen.</p> <p>Alternate the pointing tool's frequency. (See the <b>Reducing Monitor Interference</b> section.)</p>
<p><b>Unable to use the entire tablet surface</b></p>	<p>Incorrect format selected.</p> <p>Software application setup incorrectly.</p>	<p>Check your selections in the Menu Strip.</p> <p>Check that the tablet is identified in your software application.</p>

### ***Returning your Tablet for Repair***

If you believe you have a defective tablet, first see all topics in this section (above) and visit our website at [www.gtcocalcomp.com](http://www.gtcocalcomp.com) for the latest support information.

If you're still unable to properly operate your digitizer system, please call Technical Support at 1.866.746.3015 or email us at [gtco.support@gtcocalcomp.com](mailto:gtco.support@gtcocalcomp.com).

Technical Support will assist you in determining if your tablet is defective and will help you obtain a Return Merchandise Authorization (RMA) number. **Important:** Please do not return your product without first discussing the issue with, and receiving an RMA from, a GTCO CalComp by Turning Technologies Technical Support Specialist.



### ***Repackaging for Shipment***

Whenever you ship electronic equipment, try to ship it in its original packing materials. Because packing materials are static-charged, you should ship the cursor or any extra electronics boards inside approved antistatic plastic bags. If you are shipping the tablet or accessories to a GTCO CalComp by Turning Technologies Service Center for repair, attach a tag to the equipment with the following information:

- Model number
- Serial number
- Maintenance contract number (if applicable)
- Return Merchandise Authorization number
- Detailed description of the problem

### **Specifications**

#### **Communications Specifications**

The DrawingBoard III tablet uses asynchronous serial RS-232C transmission with RS-232C/CCITT V.24 signals. The host end of the cable is standard.

#### **Design Specifications**

<b>Feature</b>	<b>Description</b>
<b>Resolution</b>	Up to 12,700 lpi (500 lpmm)
<b>Accuracy</b>	<p>± .010" standard accuracy (Models 34120, 34180, 34240, 34360, 34480 and 34600)</p> <p>± .005" high accuracy (optional) (Models 34360-H1, 34480-H1 and 34600-H1)</p> <p>± .002" high accuracy (optional) (Models 34360-H2, 34480-H2 and 34600-H2)</p>
<b>Proximity</b>	>0.5" (12 mm)
<b>Jitter</b>	± 1 lsb



<b>Repeatability</b>	.001"
<b>Maximum Data Rate</b>	>200 pps (corded) >170 pps (cordless)

### Electrical Specifications

Feature	Description
<b>Power Source</b>	Wall mount power supply with a 2.1 mm mono plug DC connector and positive outside diameter
<b>Input Voltage</b>	12 to 17 VDC
<b>Current Draw</b>	400 ma

### Regulatory Specifications

Feature	Description
<b>Safety</b>	UL1950, EN60950
<b>Electromagnetic/Immunity</b>	FCC Class B, DOC Class B, VCCI Class II, EN50082-1 and EN55022

### Environmental Specifications

Feature	Description
<b>Operating Temperature</b>	50° to 104°F (10° to 40°C)
<b>Storage Temperature</b>	-40° to 158°F (-40° to 70°C)
<b>Humidity Range</b>	0% to 95%, non-condensing
<b>Operating Altitude</b>	Up to 15,000 ft. (4,572m) above sea level

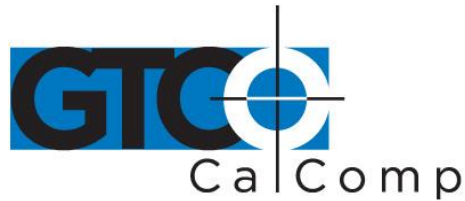

by TURNING technologies

**Storage Altitude**

Up to 50,000 ft. (15,244m) above sea level

**Physical Specifications**

Model	Active Area	Footprint	Weight	Shipping Weight
<b>DB4-2024</b>	20 in x 24 in (508 mm x 610 mm)	29 in x 34 in (737 mm x 864 mm)	23 lb. (10.5 kg)	30 lb. (13.6 kg)
<b>DB4-2436</b>	24 in x 36 in (610 mm x 914 mm)	32.5 in x 46 in (826 mm x 1168 mm)	25 lb. (11.4 kg)	45 lb. (20.4 kg)
<b>DB4-3648</b>	36 in x 48 in (914 mm x 1219 mm)	44.5 in x 60 in (1130 mm x 1524 mm)	40 lb. (18.2 kg)	71 lb. (32.2 kg)
<b>DB4-4460</b>	44 in x 60 in (1117 mm x 1524 mm)	52.5 in x 69 in (1333 mm x 1753 mm)	69 lb. (31.3 kg)	93 lb. (42.1 kg)

**Parts and Accessories**

The following tablet lists the DrawingBoard III systems and parts available for purchase. To order any of the items listed below, please contact GTCO CalComp by Turning Technologies at 1.866.746.3015 (Toll Free), fax to 480.998.1751, visit us online at [www.gtcocalcomp.com](http://www.gtcocalcomp.com), or email to [gtco.sales@gtcocalcomp.com](mailto:gtco.sales@gtcocalcomp.com).

Tablets	Model	Description
	34120	12 x 12" active area
	34180	12 x 18" active area
	34240	18 x 24" active area
	34360	24 x 36" active area
	34480	36 x 48" active area
	34600	44 x 60" active area

*Models 34360, 34480 and 34600 available with high accuracy.*

**Pointing Tools**

- 4-button cursor, corded
- 4-button cursor, cordless
- 16-button cursor, corded
- 16-button cursor, cordless
- 16-button cursor, high accuracy
- Two-side button/click tip pen, corded
- Two-side button/click tip pen, cordless
- Two-side button/pressure tip pen, cordless



## Accessories

Accessory tray  
 Power supply, 100/110V  
 Power supply, 220/240V  
 I/O cable with 9-pin connector  
 9- to 25-pin adapter  
 Magnifier lens for high accuracy cursor  
 Replacement overlay (12" x 12")  
 Replacement overlay (12" x 18")  
 Replacement overlay (18" x 24")  
 Six hearing aid type batteries for pens  
 Replacement tips for pen (3 pack)

## Glossary

### Accuracy

The similarity of a distance measured by the tablet with the actual distance. When we specify that the accuracy of a tablet is  $\pm .010$  inches, we mean that every point in the drawing area is within .010 inches of where it should be.

### ASCII

Abbreviation for *American Standard Code for Information Interchange*.

### Baud Rate

Rate of speed that data flows between a host computer and the digitizer. It is the number of bits transmitted per second. The lower the baud rate, the slower the speed.

### Bit

Basic unit of information in the binary system – either 0 or 1.

### Button

Switch on the cursor or pen used to input data.

### Byte

Group of eight bits that acts as a single unit of information.

**Coordinate Pair**

Pair of numbers representing a unique point on the digitizer surface, usually the distance across and up from the tablet origin.

**CR**

The ASCII Carriage Return character usually added to the end of the X,Y coordinate pairs sent by the tablet (ASCII formats).

**Cursor**

- 1.) Transducer used to select specific points on the tablet surface.
- 2.) Symbol displayed on the screen marking where the next action will take effect, or where the next character typed from the keyboard will appear.

**Data Bits**

Each transmission contains 7 or 8 data bits.

**Data Rate**

Number of coordinate pairs (X,Y) the tablet sends to the computer per second.

**Default**

A value, action or setting that a computer system assumes, unless the user gives an explicit instruction to the contrary.

**Drawing Area**

Area on the tablet surface intended for digitizing.

**Format**

The form in which data is sent from the tablet. DrawingBoard IV tablet can output 32 different formats.

**Frequency**

Number of waves that pass a fixed point in one second.

**Height**

See Proximity.

**Increment Modes**

This mode is used with other operating modes. Data points are sent only if the pointing tool has moved the required increment distance in either the X or Y direction and has satisfied the requirements of the operating mode. These increment distances are set separately for each axis.

**Jitter**

Repeatability error of short duration caused by electrical noise.

**Key**

Portion of the tablet surface available to the user for tablet setup.

**Line Feed**

Optional character added to the end of an output format that causes the printer to move to the next line, or causes a line to be added on the display screen.

**Line Mode**

The tablet sends coordinate data points continuously, while the pen tip or a cursor button is depressed, and one additional point when the pen tip or cursor button is released.

**LPI**

Abbreviation for *lines per inch*. English unit of measurement for resolution measuring the number of separate, distinguishable locations that may be found within the distance of one inch.

**LPmm**

Abbreviation for *lines per millimeter*. Metric unit of measurement for resolution measuring the number of separate, distinguishable locations that may be found within the distance of one millimeter.

**Mouse Mode**

Operating mode that emulates Microsoft and Mouse Systems mouse drivers. Data constantly transmits when the cursor or pen is on the drawing area of the tablet.

**Operating Mode**

The conditions that must be met before the tablet sends information to the computer.

**Output Format**

System of characters used by the DrawingBoard IV tablet for outputting data.

**Parity**

Type of error detection where a bit is inserted into every character the digitizer transmits. The status of the parity bit confirms that the data was not altered during transmission.

**Pen Tilt Correction**

An option that allows for tilt correction in the pressure pen.

**Pen Tilt Data**

An option that allows output of tilt data in the pressure pen.

**Point Mode**

The digitizer transmits one coordinate data point when a cursor button or the pen tip is depressed.

**Pointing Tool**

Tool used to digitize; it may be either a cursor or pen.

**Pressure Pen Data**

Data output from the pressure pen.

**Prompt Mode**

The digitizer transmits one coordinate pair each time the computer sends a prompt character to the unit. Prompting can operate with any mode except Mouse mode.

**Proximity**

Greatest distance above the drawing area that the pointing tool can be raised and still be sensed by the tablet.

**RAM**

Abbreviation for *Random Access Memory*, a specific type of memory used by the computer.

**Resolution**

Distance increment that the tablet outputs in lines/inch or lines/mm.



**ROM**

Abbreviation for *Read Only Memory*, a specific type of memory used by the computer.

**Run Mode**

The digitizer transmits coordinate data points continuously, regardless of the status of the cursor buttons or the pen tip. This mode is also called *Stream* by some manufacturers.

**Serial Transmission**

Data transmission protocol where each bit of the data character is sent one at a time over a single circuit. This system saves on transmission circuitry, but is usually slower than parallel transmission.

**Stop Bits**

One or two stop bits are transmitted with each data byte. They mark a completed transmission.

**Track Mode**

The digitizer transmits coordinate data points continuously, but only while the cursor button or pen tip is depressed. This mode is also called *Switch Stream* by some manufacturers.

**X Direction**

Horizontal direction across the face of the tablet.

**Y Direction**

Vertical distance up and down the face of the tablet.



## Regulatory Statements and Warranty

### ***Radio and Television Interference***

The user is cautioned that any changes or modifications not expressly approved by the party responsible for compliance could void the user's authority to operate the equipment.

This equipment has been tested and found to comply with the limits of a Class B digital device, pursuant to Part 15 of the FCC rules. These limits are designed to provide reasonable protection against harmful interference in a residential installation. This equipment generates, uses and can radiate radio frequency energy and, if not installed and used in accordance with the instructions, may cause harmful interference to radio communications. However, there is no guarantee the interference will not occur in a particular installation. If this equipment does cause harmful interference to radio or television reception, which can be determined by turning the equipment off and on, the user is encouraged to try to correct the interference by one or more of the following measures:

- Reorient or relocate the receiving antenna.
- Increase the separation between the equipment and the receiver.
- Connect the equipment into an outlet on a circuit different from that to which the receiver is connected.
- Reorient or coil cables.
- Consult the dealer or an experienced Radio/TV technician for help.

**NOTE:** Any cables the user adds to the device must be shielded to be in compliance with the FCC standards. Any unauthorized modification to this device could result in the revocation of the end user's authority to operate this device.

### ***Canada***

This digital apparatus does not exceed the Class B limits for radio noise emissions from digital apparatus as set out in the radio interference regulations of the Canadian Department of Communications.

*Le present appareil numérique n'émet pas bruits radioélectriques dépassant les limites applicables aux appareils numériques de Classe B prescrites dans le règlement sur le brouillage radioélectrique édicte par le Ministère des Communications du Canada.*



### ***European Union Emission Directive***

This product is in conformity with the protection requirements of EU Council Directive 89/366/ECC on the approximation of the laws of the Member States relating to electromagnetic compatibility.

This product has been tested and found to comply with the limits for Class B Information Technology Equipment according to CISPR 22/European Standard EN55022. The limits for Class B equipment were derived for typical industrial environments to provide reasonable protection against interference with licensed communication devices.

### ***European Union WEEE Directive***

The manufacture of this equipment required the extraction and use of natural resources. It may contain hazardous substances that could impact health and the environment.

- In order to avoid the dissemination of the hazardous substances into the environment and to diminish the pressure on our natural resources, GTCO CalComp by Turning Technologies encourages you to return this product to the appropriate take-back system facility. These facilities reuse or recycle most of the materials in this equipment in a responsible way.
- The crossed-out wheeled bin symbol below invites you to use these take-back systems.
- If you need more information about the collection, reuse and recycling systems in your area, please contact your local or regional waste authority.
- Further information about the responsible end-of-life management of this and other GTCO CalComp by Turning Technologies products is available on our website at [www.gtcocalcomp.com](http://www.gtcocalcomp.com).



**Japan**

この装置は、情報処理装置等電波障害自主規制協議会（VCCI）の基準に基づくクラスB 情報技術装置です。この装置は、家庭環境で使用することを目的としていますが、この装置がラジオやテレビジョン受信機に近接して使用されると、受信障害を引き起こすことがあります。  
取扱説明書に従って正しい取り扱いをして下さい。

**CE Certification**

Declaration of conformity according to ISO/IEC Guide 22 and EN 45014

**Manufacturer's Name:** GTCO CalComp by Turning Technologies, Inc.  
**Manufacturer's Address:** 14557 N. 82<sup>nd</sup> Street  
Scottsdale, Arizona 85260

Declares, that the product:

**Product Name:** DrawingBoard III  
**Model Numbers:** 34120, 34180, 34240, 34360, 34480, 34600, 34365, 34485 and 34605  
**Product Options:** All

Conforms to the following product specifications:

**Safety:** UL 1950, EN 60950:1988+A1+A2  
**EMC:** CISPR22: 985/EN 55022:1988-Class B  
EN 50082-1:1992  
IEC 801-2:1991-4kV CD, 8kV AD, Criterion B  
IEC 801-3:1984-3V/m, Criterion A  
IEC 801-4:1988-1kV power lines, 5kV data lines, Criterion B

**Supplementary Information**

The product herewith complies with the requirements of the Low Voltage Directive 73/23/EEC and the EMC Directive 89/336/EEC.

Scottsdale, Arizona  
**Location**

6-18-1999  
**Date**

Dana Doubrava  
**Engineering Manager**



### **Limited Warranty for DrawingBoard III**

GTCO CalComp by Turning Technologies, Inc. warrants these products to be free from defects in material and workmanship under the following terms. Complete and return the enclosed warranty registration card to ensure that your products are covered with this warranty.

#### **Coverage**

Parts and labor are warranted for one (1) year from the date of the first consumer purchase for the digitizer tablet, controller, transducers and tablet accessories. Power supply and cables are also warranted for one (1) year. This warranty applies to the **original consumer purchaser only**.

Within the European Union, the warranty period is two (2) years, as mandated by the EU. Contact your local dealer or distributor for additional warranty information.

Warranty is only valid if original consumer's purchase or lease date is less than or equal to six months from the original GTCO CalComp by Turning Technologies sale date. This information will be captured by the system serial number and confirmed by the reseller's purchase order.

A nominal Warranty Handling Fee will be charged after the first 90 days of use and calculated from the date of original consumer purchase. This payment may be made by Visa, MasterCard or American Express. A copy of the sales receipt or invoice will be required for warranty verification.

#### **Conditions**

Except as specified below, this warranty covers all defects in material or workmanship in the products. The following are not covered by the warranty:

1. Any product on which the serial number has been defaced, modified or removed (if applicable).
2. Damage, deterioration or malfunction resulting from:
  - a. Accident, misuse, abuse, neglect, fire, water, lightning or other acts of nature, unauthorized modification for any purpose, unauthorized product modification, or failure to follow instructions supplied with the product.
  - b. Repair or attempted repair by anyone not authorized by GTCO CalComp by Turning Technologies.
  - c. Any damage in shipment of the product (claims must be presented to the carrier).
  - d. Any other cause which does not relate to a manufacturing defect.
3. Any product not sold or leased to a consumer within six months of GTCO CALCOMP BY TURNING TECHNOLOGIES original sale date.

GTCO CalComp by Turning Technologies will pay all labor and material expenses for covered items, but will not pay for the following:

1. Removal or installation charges.



2. Costs for initial technical adjustments (setup), including adjustment of user controls.
3. Certain shipping charges. (Payment of shipping charges is discussed in the next section of this warranty.)
4. Packaging costs. (Customers should keep their boxes.)

### **Warranty Service Procedures**

1. To obtain service on your GTCO CalComp by Turning Technologies product, contact the Technical Support Department to receive a Return Material Authorization Number (RMA#) and shipping instructions by calling: 1-866-746-3015.
2. Ship the product to GTCO CalComp by Turning Technologies with the RMA# marked clearly on the outside of the box. Without a clearly marked RMA# on the shipping box, GTCO CalComp by Turning Technologies reserves the right to refuse the shipment.
3. Although you must pay any shipping charges to ship the product to GTCO CalComp by Turning Technologies for warranty service, GTCO CalComp by Turning Technologies will pay the return shipping charges for ground shipment. Other shipping options are available at an additional fee.
4. Whenever warranty service is required, the original dated sales invoice (or a copy) must be presented as proof of warranty coverage and should be included in shipment of the product. Please also include your name, address, telephone number, fax number, email address and a description of the problem.
5. If GTCO CalComp by Turning Technologies determines that the unit is not defective within the terms of the warranty, the consumer shall pay the cost of all freight charges, as well as any repair charges.

### **Technical Support**

Web-based Technical Support is available free of charge at: [www.gtcocalcomp.com](http://www.gtcocalcomp.com), where current driver releases, as well as comprehensive technical support, troubleshooting, Technical Bulletins and FAQs can be found.

Telephone Technical Support is available free of charge to the original consumer for a period of 90 days from the date of purchase of the product. Please contact our Technical Support Department at: 1-866-746-3015 or fax your request to: 480.998.1751.

### **Disclaimer of Unstated Warranties**

The warranty printed above is the only warranty applicable to this purchase. ALL OTHER WARRANTIES, EXPRESS OR IMPLIED, INCLUDING, BUT NOT LIMITED TO, THE IMPLIED WARRANTIES OF MERCHANTABILITY AND FITNESS FOR A PARTICULAR PURPOSE ARE DISCLAIMED. Assuming the warranty above stated is otherwise applicable, it is expressly understood and agreed that GTCO CalComp by Turning Technologies sole liability whether in contract, tort, under any warranty, in negligence or other shall be for the repair or replacement of the defective parts and under no circumstances shall GTCO CalComp by Turning Technologies be liable for special, indirect or



consequential damages. The price stated and paid for the equipment is a consideration in limiting GTCO CalComp by Turning Technologies liability.

**Notice**

Some states and provinces do not allow the exclusion or limitation of incidental or consequential damages, so the above exclusion may not apply to you. This warranty gives you specific legal rights, and you may have other rights, which vary from state to state, or province to province.

To obtain service on your GTCO CalComp by Turning Technologies product, call our Technical Support Department at: 1-866-746-3015 or fax us at (480) 998-1751. We can also be contacted through our website at [www.gtccalcomp.com](http://www.gtccalcomp.com) (in US); at [EUOffice@gtccalcomp.com](mailto:EUOffice@gtccalcomp.com) (in Germany); at [infos@calcomp.fr](mailto:infos@calcomp.fr) (in France).

**Important!**

All products returned to GTCO CalComp by Turning Technologies for service must have prior approval in the form of a Return Merchandise Authorization Number (RMA#), which can be obtained by calling the Technical Support Department.



**Corporate Headquarters**

14557 N. 82<sup>nd</sup> Street  
Scottsdale, Arizona 85260  
Tel: 1-866-746-3015  
Support: 1-866-746-3015  
Fax: 480-998-1751

[www.gtcocalcomp.com](http://www.gtcocalcomp.com)

Support: 1.866.746.3015

**DRAWINGBOARD III™**

Copyright© 2014 GTCO CalComp by Turning Technologies, Inc.  
DrawingBoard III is a trademark of GTCO CalComp by Turning Technologies, Inc.  
All other products and company names are the trademarks or registered trademarks of their respective owners.

The information contained in this document is subject to change without notice. GTCO CalComp by Turning Technologies assumes no responsibility for technical, or editorial errors, or omissions that may appear in this document, or for the use of this material. Nor does GTCO CalComp by Turning Technologies make any commitment to update the information contained in this document. This document contains proprietary information which is protected by copyright. All rights reserved. No part of this document can be photocopied or reproduced in any form without the prior, written consent of GTCO CalComp by Turning Technologies, Inc.